

# Półka wisząca

Czas mont. - 30 min.

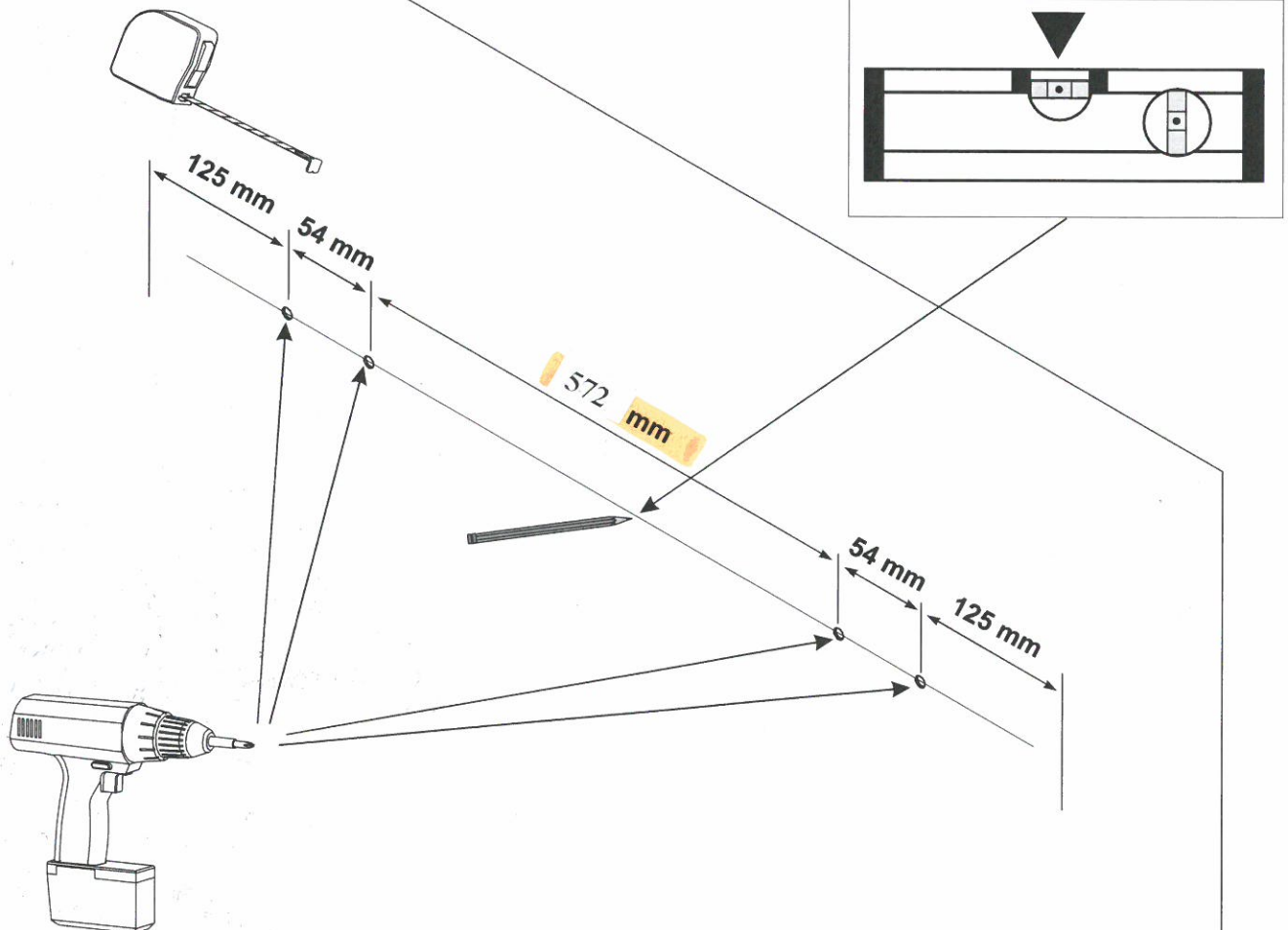
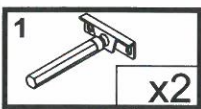
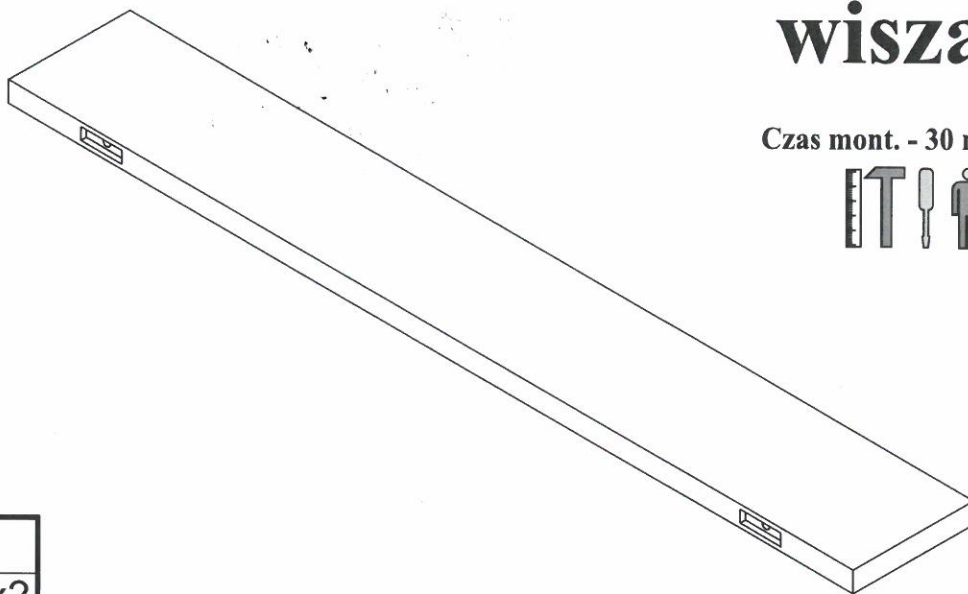

W zależności od rodzaju ściany dobieramy odpowiedni rodzaj okucia do montażu. Jeżeli nie są Państwo pewni natury ściany prosimy zasięgnąć porady specjalisty.

# 2

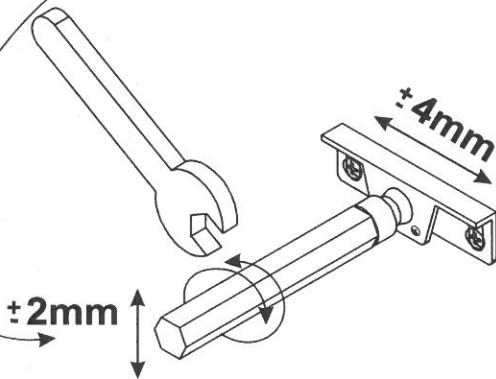
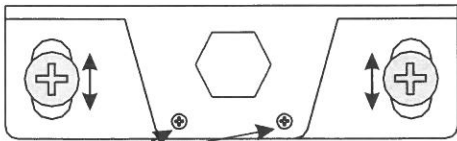
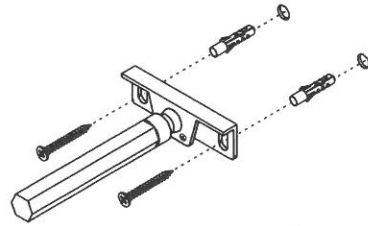
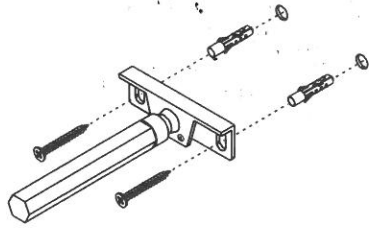

# 3

