



www.MLMEBLE.pl

GB

D

CZ

SK

RUS

LT

assembly instructions / montageanleitung / montážní návod / montážny návod / инструкции по монтажу / surinkimo instrukcija







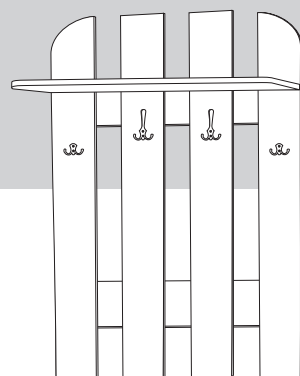

# INSTRUKCJA MONTAŻU

W 90-01

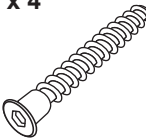
↑ 120 → 90 ↗ 24



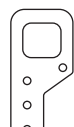
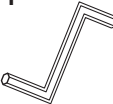
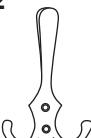

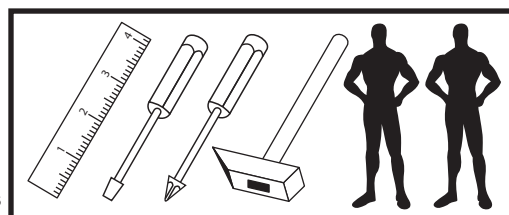

akcesoria / accessories / zubehör / příslušenství / príslušenstvo / аксессуары / furnitūra :

<p>x 4</p>  <p>KT 7/60</p>	<p>x 8</p>  <p>WT 3x16</p>	<p>x 16</p>  <p>WT 4x30</p>	<p>x 8</p>  <p>WT 3,5x20</p>	<p>x 2</p>  <p>ZA P90x37</p>	<p>x 1</p>  <p>kluczyk / key / schlüssel / klíč / ключ / raktas</p>	<p>x 2</p>  <p>WK 3N</p>	<p>x 2</p>  <p>WK 2N</p>
---	---	--	---	---	--	---	---

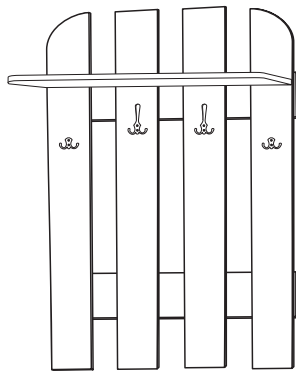
do montażu potrzebne są:  
are needed for assembly:  
sind erforderlich für die montage:  
jsou potřebné pro montáž:  
sú potrebné pre montáž:  
которые необходимы для сборки:  
Surinkimui reikės





	CODE			
1	W9001_01	1200	164	1
2	W9001_02	870	200	1
3	W9001_03	870	100	2
4	W9001_04	1200	164	1
5	W9001_05	1200	164	2
6				
7				
8				
9				
10				

