



www.MLMEBLE.pl

GB

D

CZ

SK

RUS

LT

assembly instructions / montageanleitung / montážní návod / montážny návod / инструкции по монтажу / surinkimo instrukcija







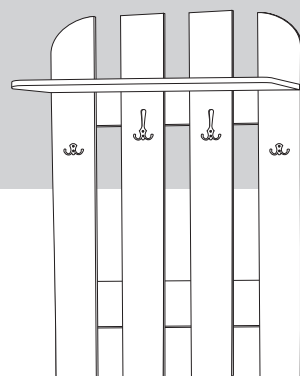

INSTRUKCJA MONTAŻU

W 80-01

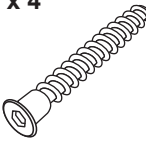
↑ 120 → 80 ↗ 24



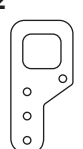
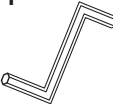
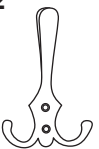

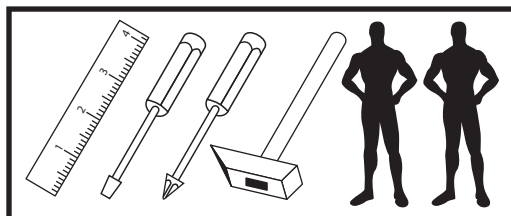

akcesoria / accessories / zubehör / příslušenství / príslušenstvo / аксессуары / furnitūra :

<p>x 4</p>  <p>KT 7/60</p>	<p>x 8</p>  <p>WT 3x16</p>	<p>x 16</p>  <p>WT 4x30</p>	<p>x 8</p>  <p>WT 3,5x20</p>	<p>x 2</p>  <p>ZA P90x37</p>	<p>x 1</p>  <p>kluczyk / key / schlüssel / klíč / ključ / ключ / raktas</p>	<p>x 2</p>  <p>WK 3N</p>	<p>x 2</p>  <p>WK 2N</p>
---	---	--	---	---	--	---	---

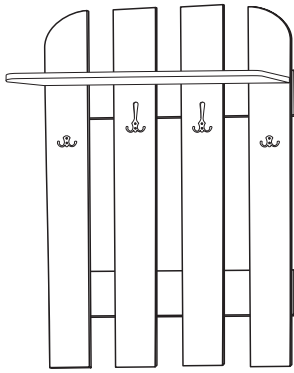
do montażu potrzebne są:
are needed for assembly:
sind erforderlich für die montage:
jsou potřebné pro montáž:
sú potrebné pre montáž:
которые необходимы для сборки:
Surinkimui reikės





	CODE			
1	W8001_01	1194	160	1
2	W8001_02	796	185	1
3	W8001_03	796	92	2
4	W8001_04	1194	160	1
5	W8001_05	1194	160	2
6				
7				
8				
9				
10				

