



www.MLMEBLE.pl

GB

D

CZ

SK

RUS

LT

assembly instructions / montageanleitung / montážní návod / montážny návod / инструкции по монтажу / surinkimo instrukcija



INSTRUKCJA MONTAŻU

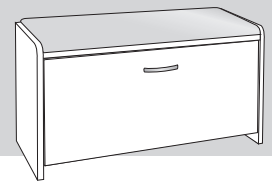

PIK 03 N

↑48 →70 ↗30

akcesoria / accessories / zubehör / příslušenství / príslušenstvo / аксессуары / furnitūra :

| | | | | | | | |
|---------------------------|-----------------------------|--------------------------|---|----------------------------|--|----------------------------|-----------------------------|
| <p>x 8</p> <p>KK 8/30</p> | <p>x 6</p> <p>KT 6,3/50</p> | <p>x 4</p> <p>SG 8/8</p> | <p>x 1</p> <p>kluczyk / key / schlüssel / klíč / kľúč / ключ / raktas</p> | <p>x 20</p> <p>GZ 1/10</p> | <p>x 1</p> <p>klej / glue / kleber / lepidlo / lepidlo / клей / klijai</p> | <p>x 16</p> <p>WT 3x16</p> | <p>x 8</p> <p>WE 6,3x16</p> |
|---------------------------|-----------------------------|--------------------------|---|----------------------------|--|----------------------------|-----------------------------|



| | | | | | | | |
|----------------------------|--------------------------------|--------------------------------|----------------------------|-----------------------|----------------------|---------------------------|--------------------------|
| <p>x 2</p> <p>ZA 3R-11</p> | <p>x 2</p> <p>TA 3R-11 Ø14</p> | <p>x 2</p> <p>TA 3R-11 Ø20</p> | <p>x 2</p> <p>OK 3R-11</p> | <p>x 6</p> <p>ZAK</p> | <p>x 2</p> <p>MB</p> | <p>x 2</p> <p>WT 4x35</p> | <p>x 1</p> <p>UT L96</p> |
|----------------------------|--------------------------------|--------------------------------|----------------------------|-----------------------|----------------------|---------------------------|--------------------------|

| |
|----------------------|
| <p>x 1</p> <p>LT</p> |
|----------------------|

do montażu potrzebne są:

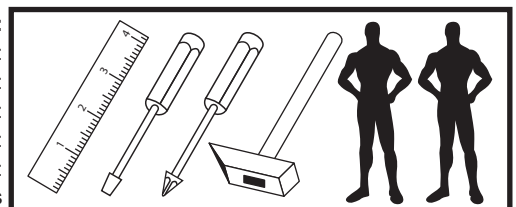
are needed for assembly:
sind erforderlich für die montage:
jsou potřebné pro montáž:
sú potrebné pre montáž:
которые необходимы для сборки:
Surinkimui reikės



| | CODE |  |  |  |
|----|--------------|---|---|---|
| 1 | PIK03N_01 | 666 | 292 | 1 |
| 2 | PIK03N_02 | 450 | 296 | 1 |
| 3 | PIK03N_03 | 662 | 356 | 1 |
| 4 | PIK03N_04 | 666 | 192 | 1 |
| 5 | PIK03N_05 | 450 | 296 | 1 |
| 6 | PIK03N_06 | 635 | 140 | 4 |
| 7 | PIK03NHDF_01 | 695 | 210 | 2 |
| 8 | SIEDZISKO | 666 | 292 | 1 |
| 9 | | | | |
| 10 | | | | |
| 11 | | | | |
| 12 | | | | |
| 13 | | | | |
| 14 | | | | |
| 15 | | | | |

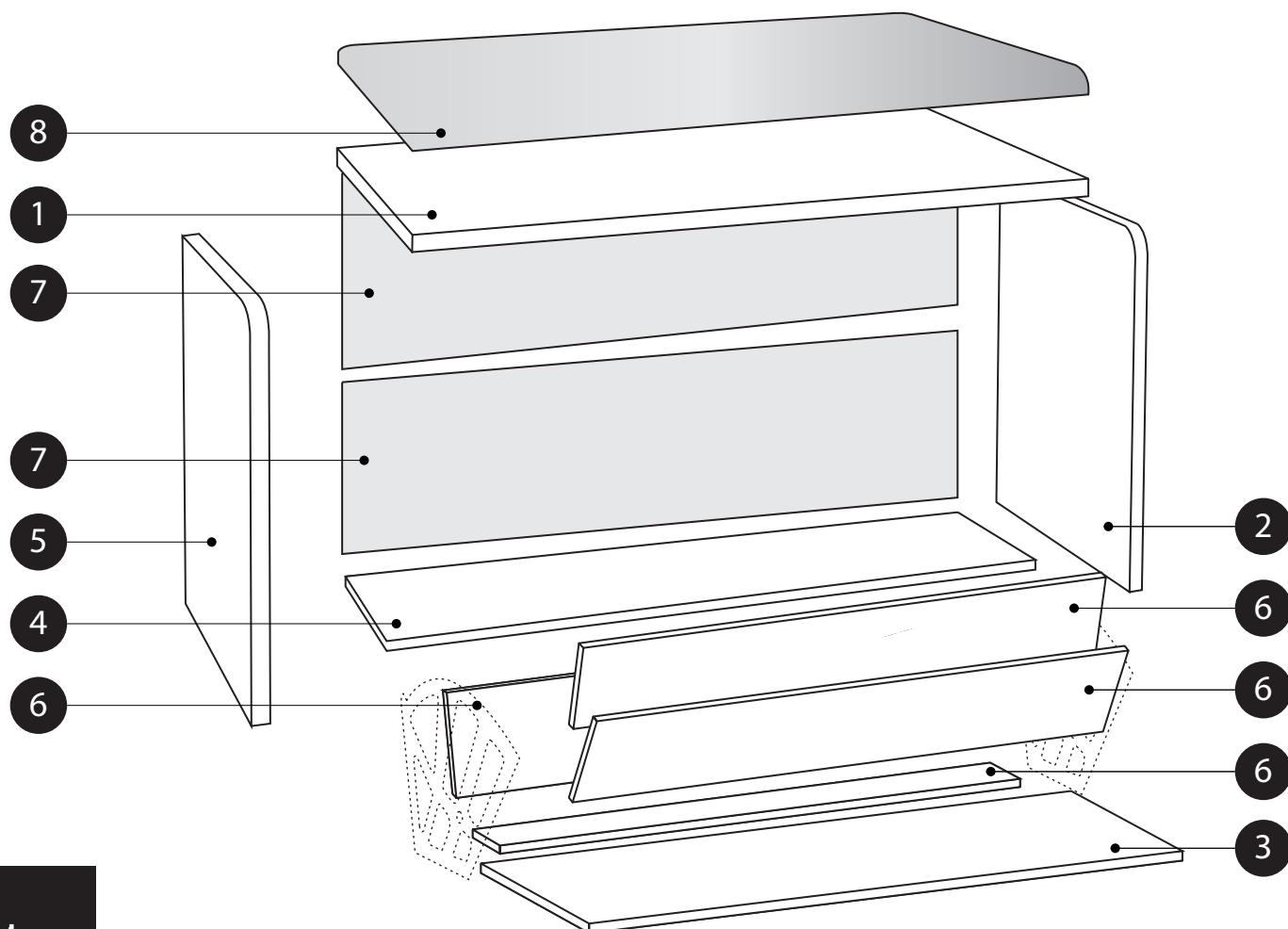
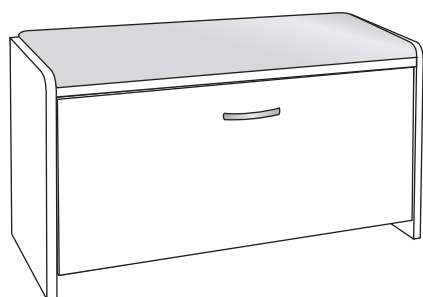

! UWAGA! - w pierwszej kolejności wbijamy akcesoria „KK” i „MD” w białą oraz boki.
WARNING! - The first accessory sticks “KK” and “MD” in the tops and sides.
WARNUNG! - Die erste Accessoire-Sticks “KK” und “MD” in den Spitzen und an den Seiten.
POZOR! - První příslušenství holt “KK” a “MD” v korunách a boky.
POZOR! - Prvé príslušenstvo palic “KK” a “MD” v korunách a boky.
ВНИМАНИЕ! - Первый аксессуаров палочки “KK” и “MD” по вершинам и по бокам.
DĚMESIO! - Pirmiausiai furtiūrą KK ir MD įkalame į stalviršį ir šonus.

