

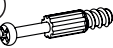















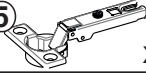

- B1**  ϕ 8x28 x20
- T1**  x20
- M1**  x20
- C2**  ϕ 20 x32
- C2**  ϕ 20 x4
- W1**  x8
- W12**  x3
- F1**  x7
- P2**  3x16 x25
- G4**  x12
- P20**  3,5x20 x2
- J23**  x10

- X5**  x4
- S9**  4x16 x8
- X19**  x2
- D2**  x4
- G5**  x2
- S4**  3x16 x2
- U39**  x2
- A14**  M4x22 x4
- T30**  x1
- T31**  x2
- S12**  4x30 x6
- F33**  x3

Nr	Ausmaß			St
1	491	290	4	1
2	696	180	4	1
3	696	494	4	1
4	200	200	10	1
5	1014	334	15	1
6	1014	334	15	1
7	1014	314	15	1
8	499	313	15	2
9	344	310	15	2
10	890	334	15	1
11	890	334	15	1
12	1040	373	16	1
13	202	510	16	1
14	202	510	16	1
15	1028	358	2	1
16	1028	513	2	1

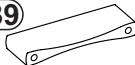

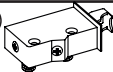
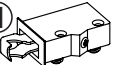
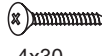
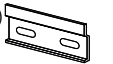
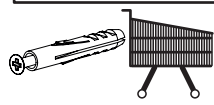
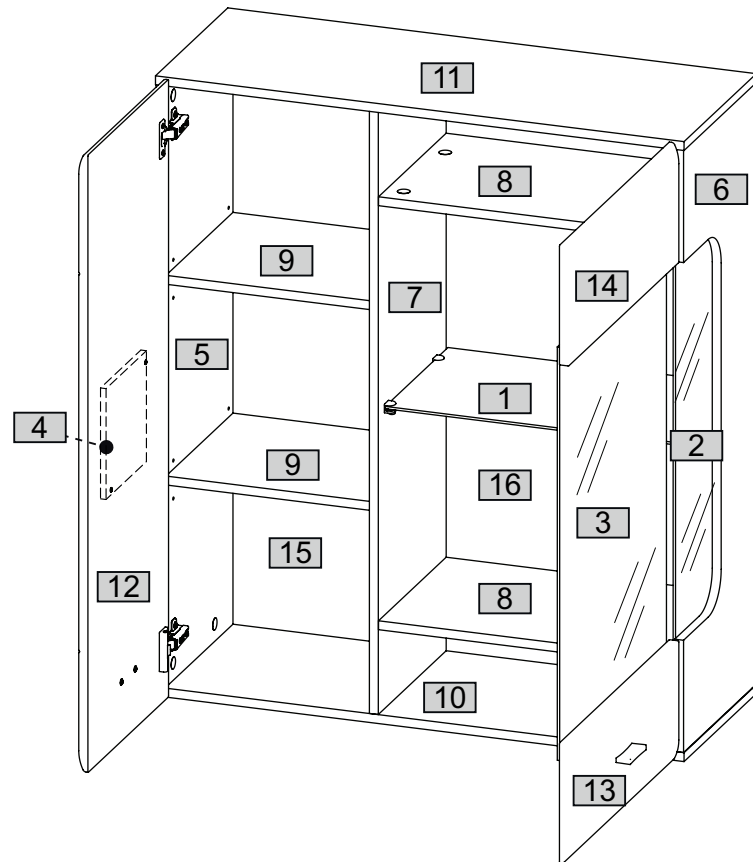
1

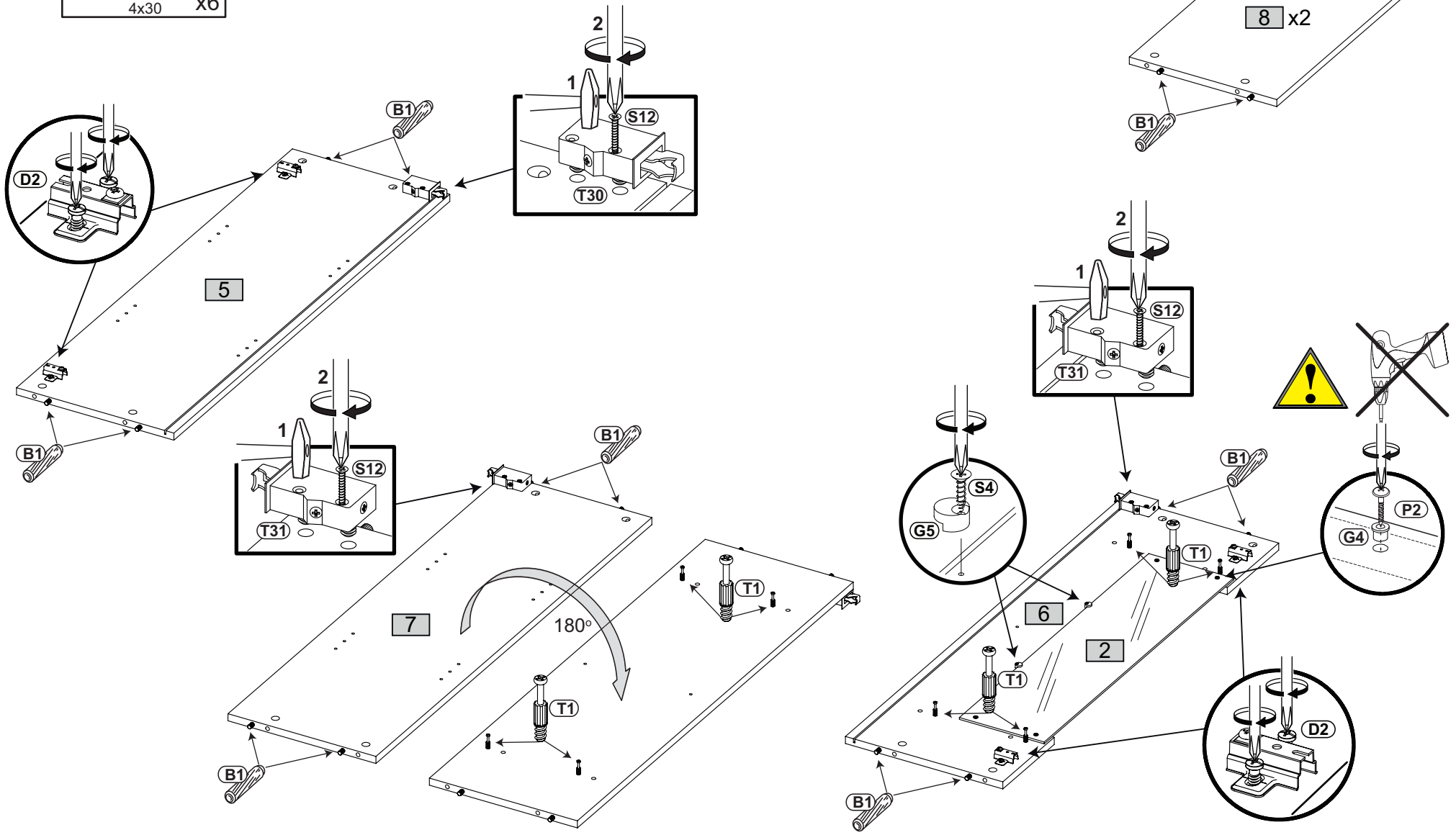
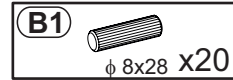
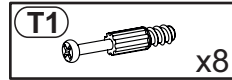
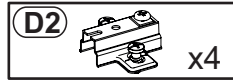
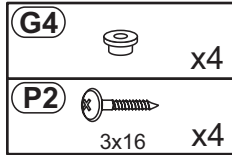
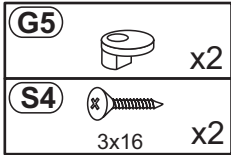
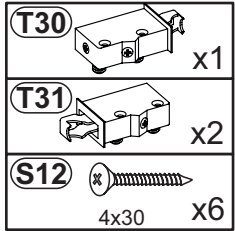

2

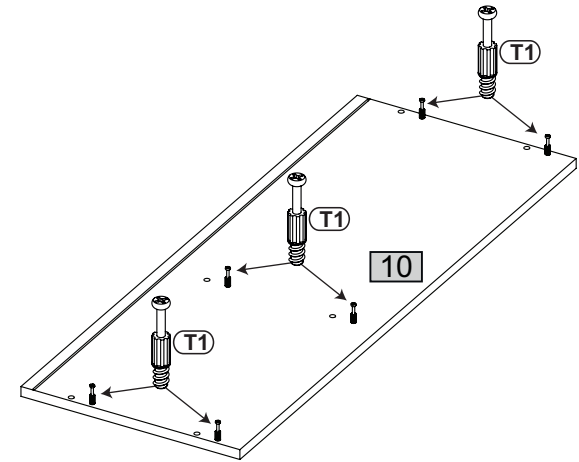
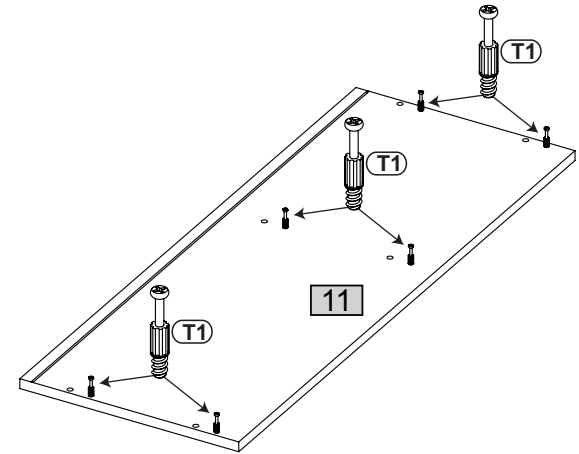
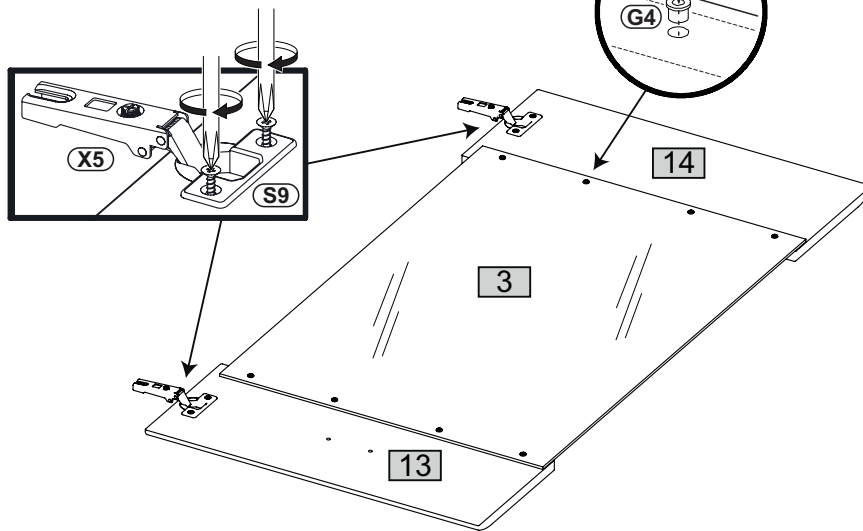
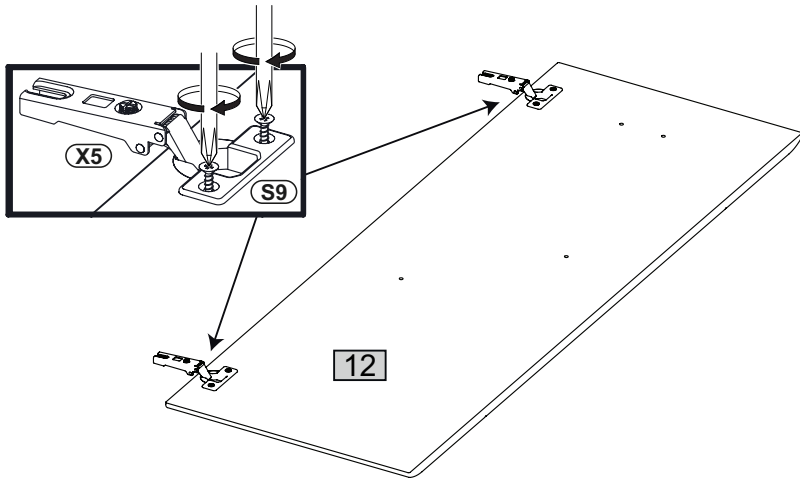
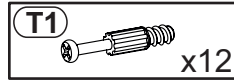
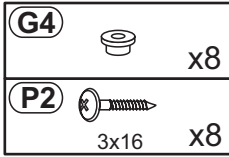
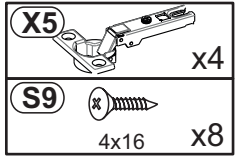

3

M1  x8

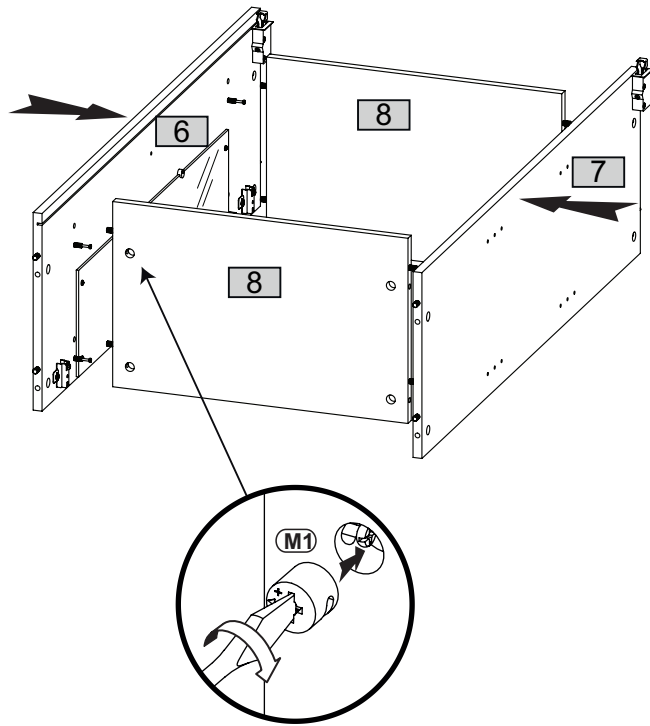

4

M1  x6

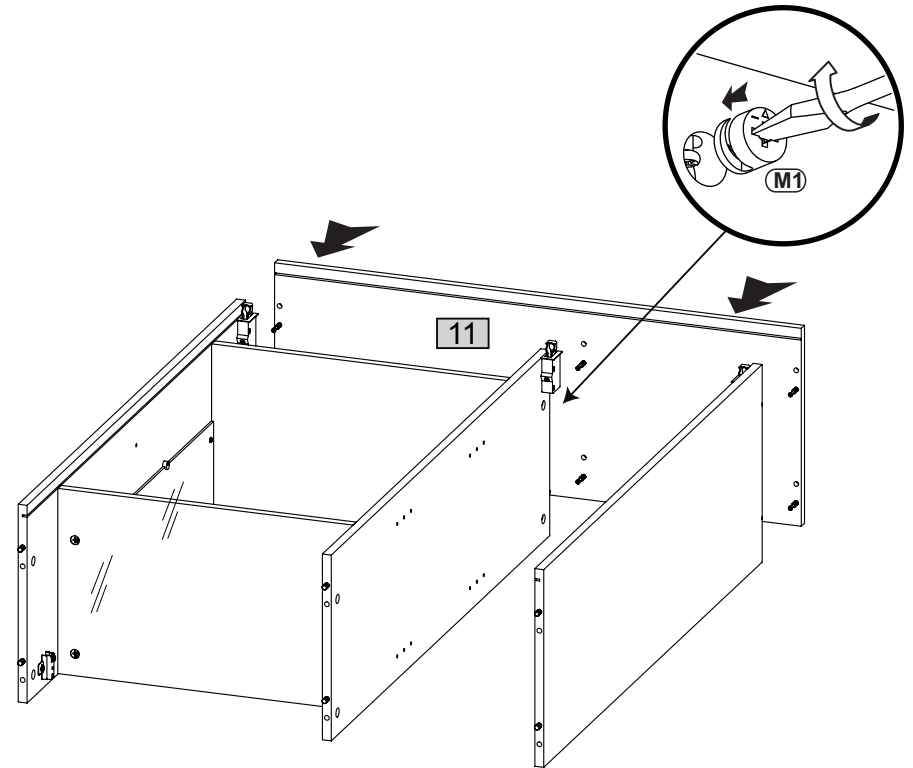

5

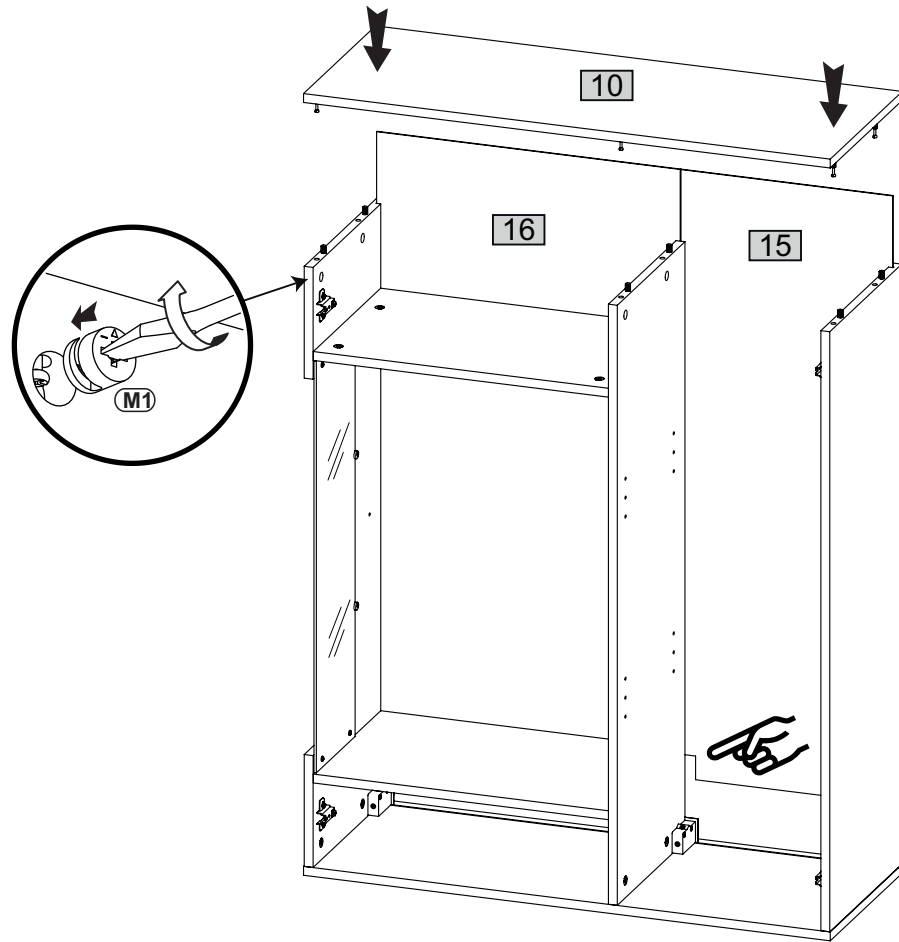

6

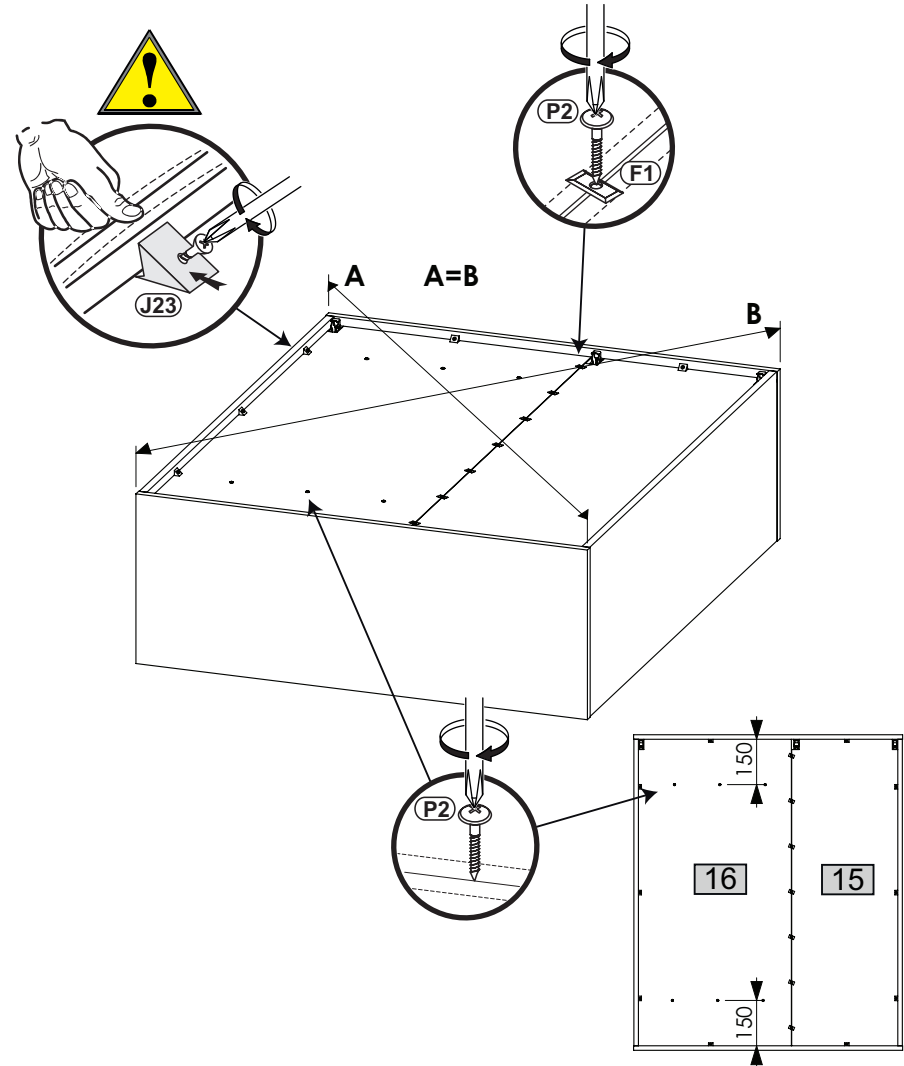
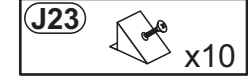
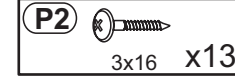

7

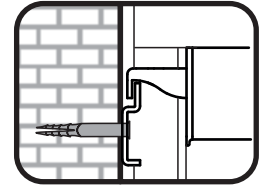
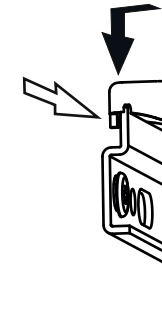
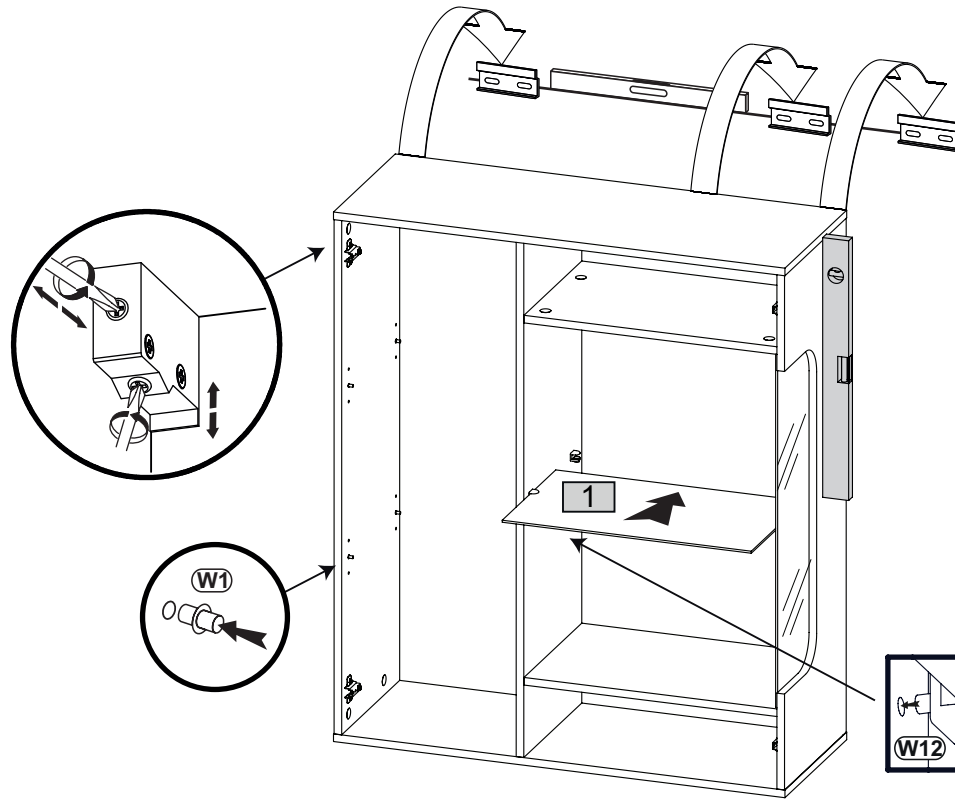
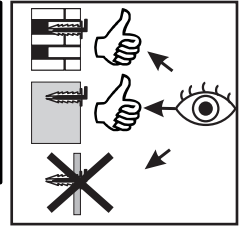
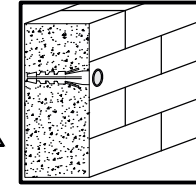
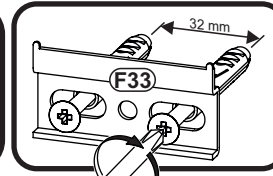
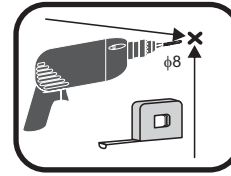
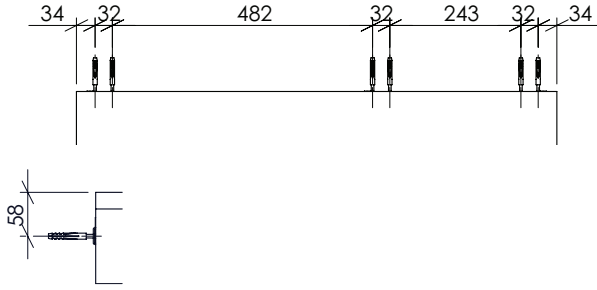
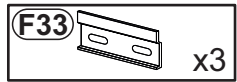
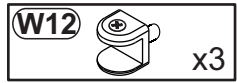
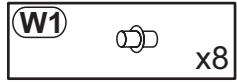

8

