

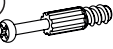















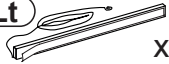

- B1**  ϕ 8x28 x32
- T1**  x38
- M1**  x38
- C2**  ϕ 20 x32
- C2**  ϕ 20 x22
- W1**  x8
- J23**  x10
- F1**  x8
- P2**  3x16 x8
- S15**  4x45 x4
- Lt**  x2
- O51**  x1

- X9**  x2
- S9**  4x16 x4
- D4**  x2
- X19**  x1
- F10**  x5
- P17**  4x20 x5
- J11**  x1
- P13**  3,5x13 x2
- 

Nr	Ausmaß		St	Colli	
1	1224	390	15	1	2
2	1224	390	15	1	2
3	1224	370	15	1	2
4	400	298	15	2	1
5	446	300	15	1	2
6	446	300	15	1	2
7	496	360	15	2	1
8	446	60	15	2	1
9	987	390	15	1	1
10	989	390	15	1	1
11	1171	443	18	1	2
12	1254	80	18	1	2
13	1254	80	18	1	2
14	829	80	18	1	1
15	1238	510	2	1	2
16	1238	460	2	1	2

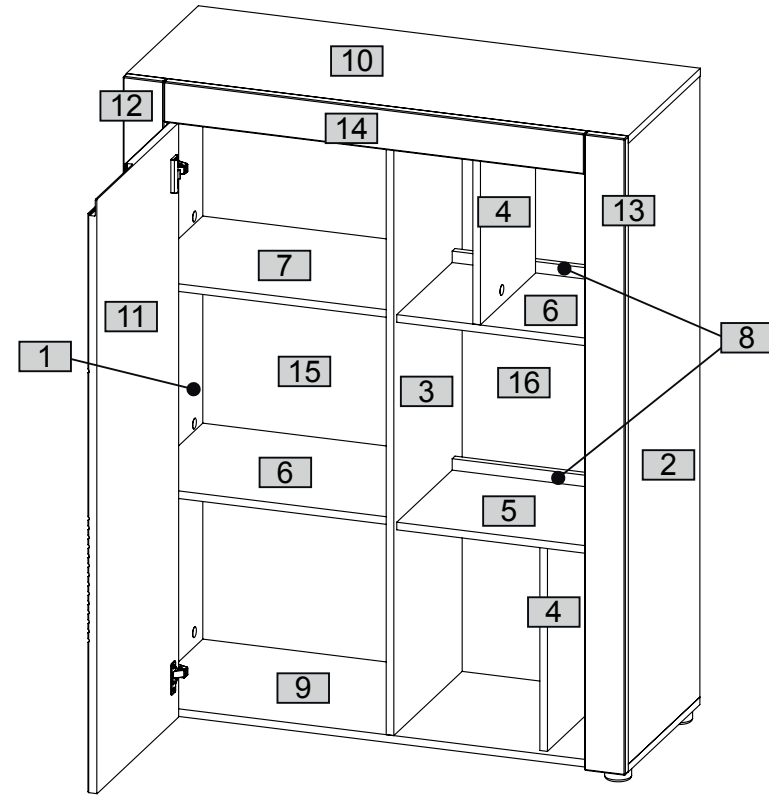

1

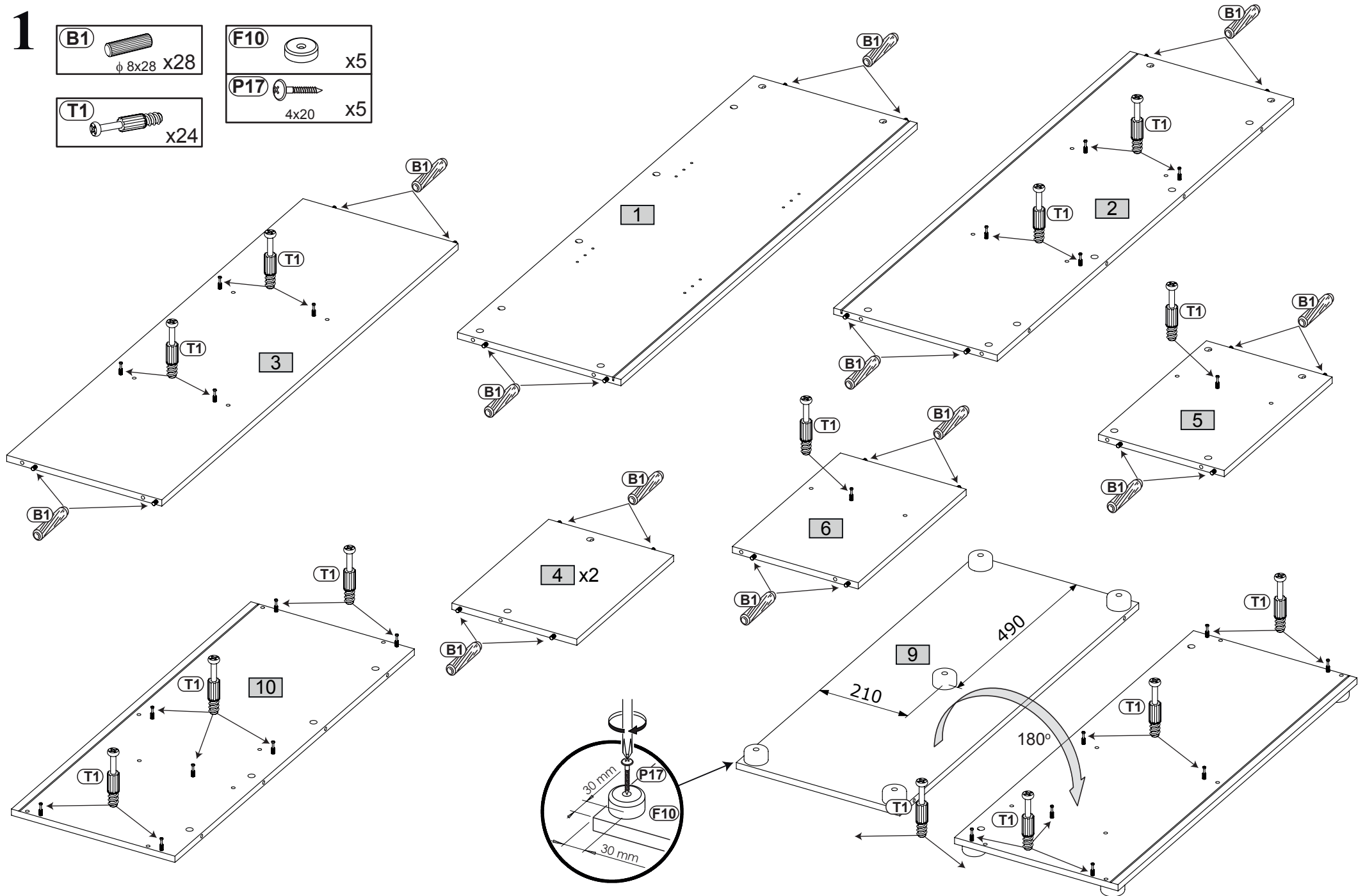
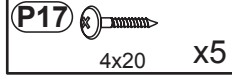
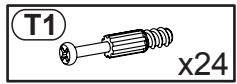
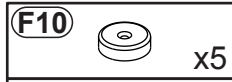
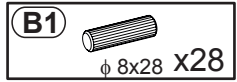

2

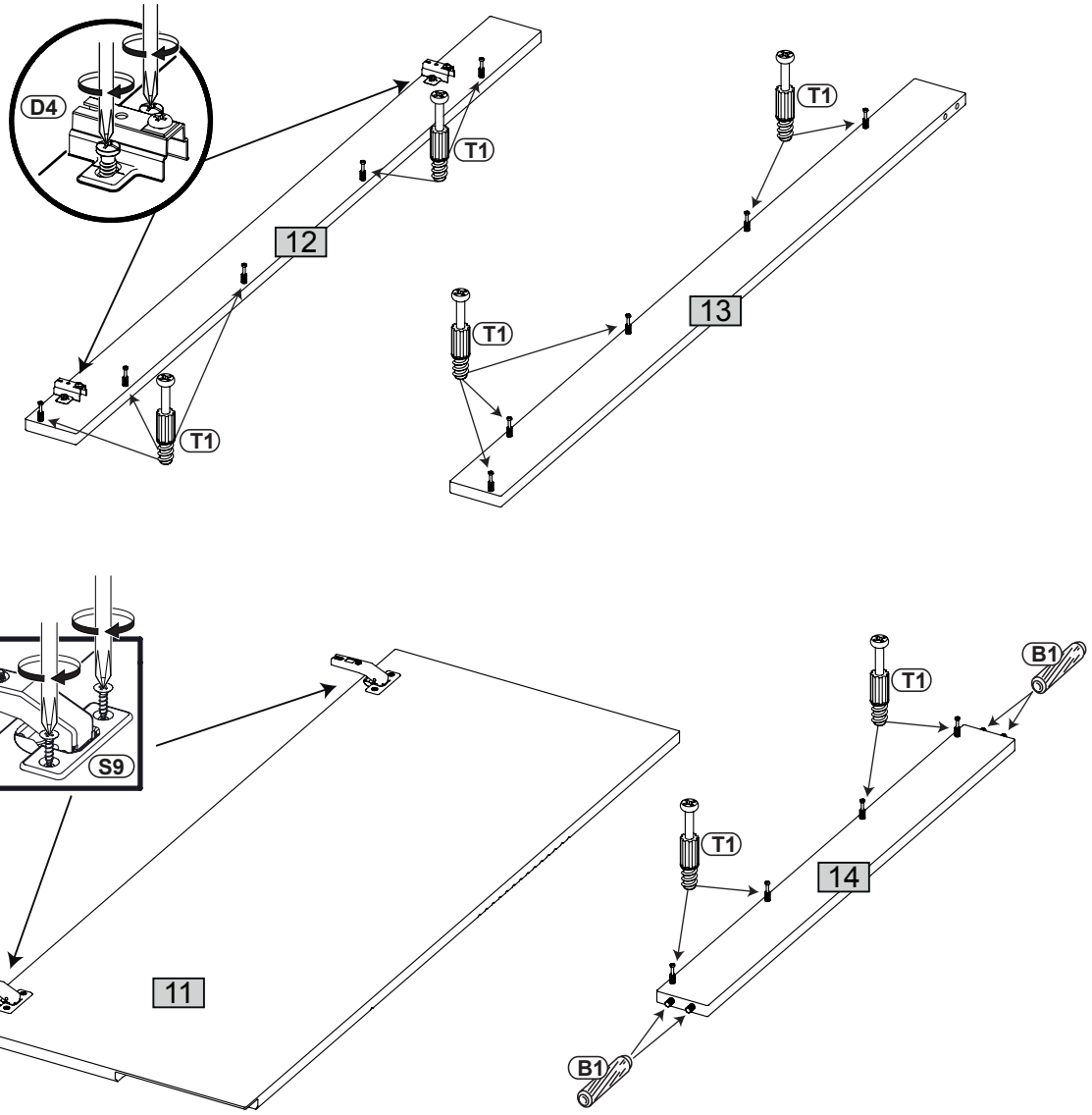
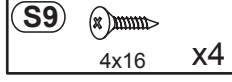
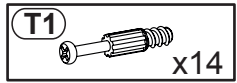
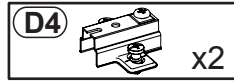
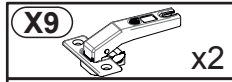
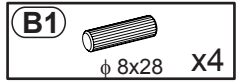

3

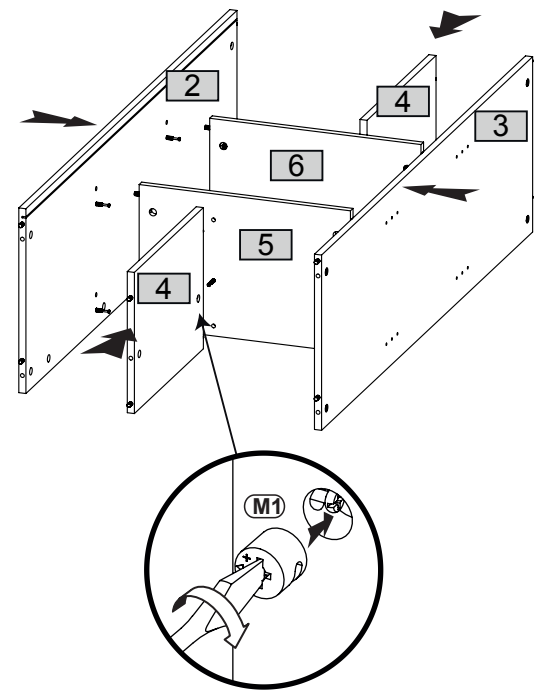

4

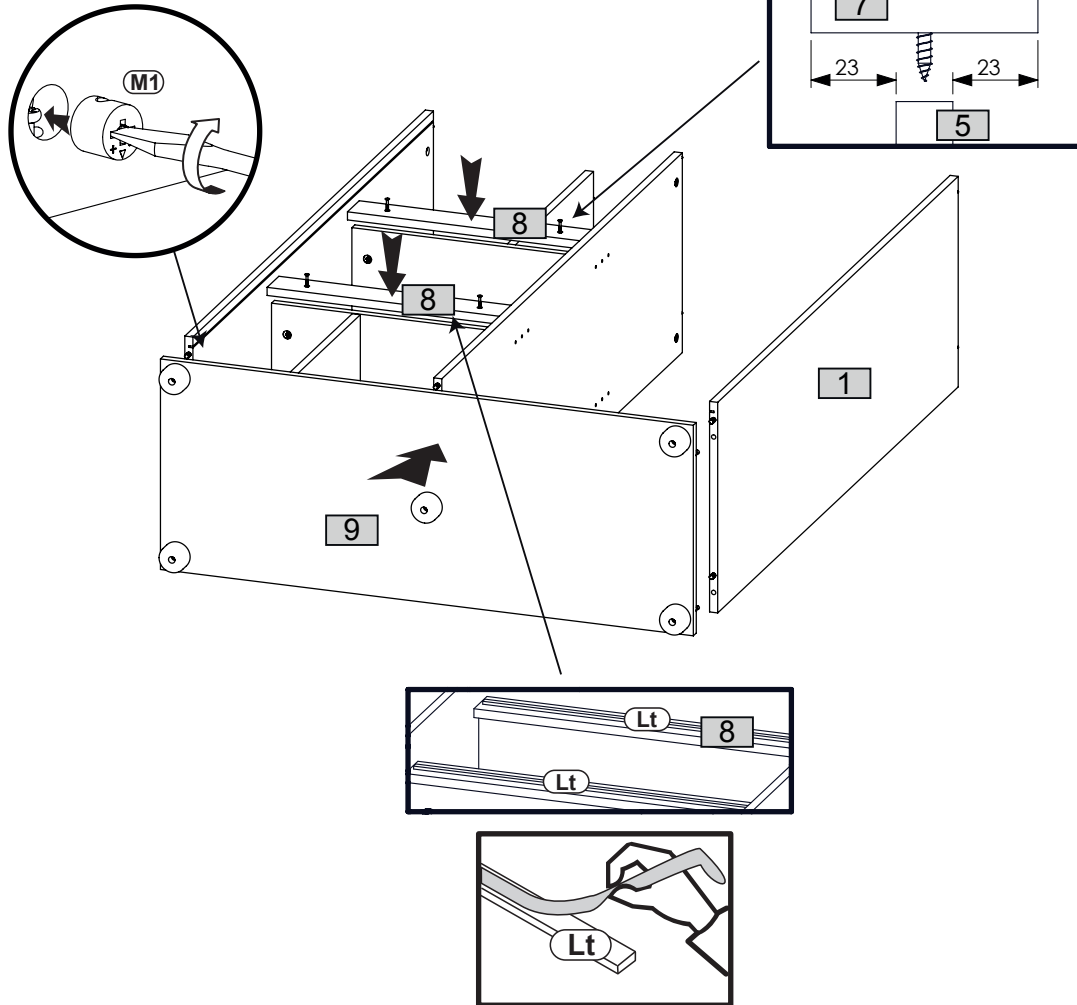
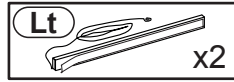
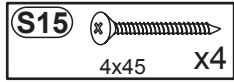

5

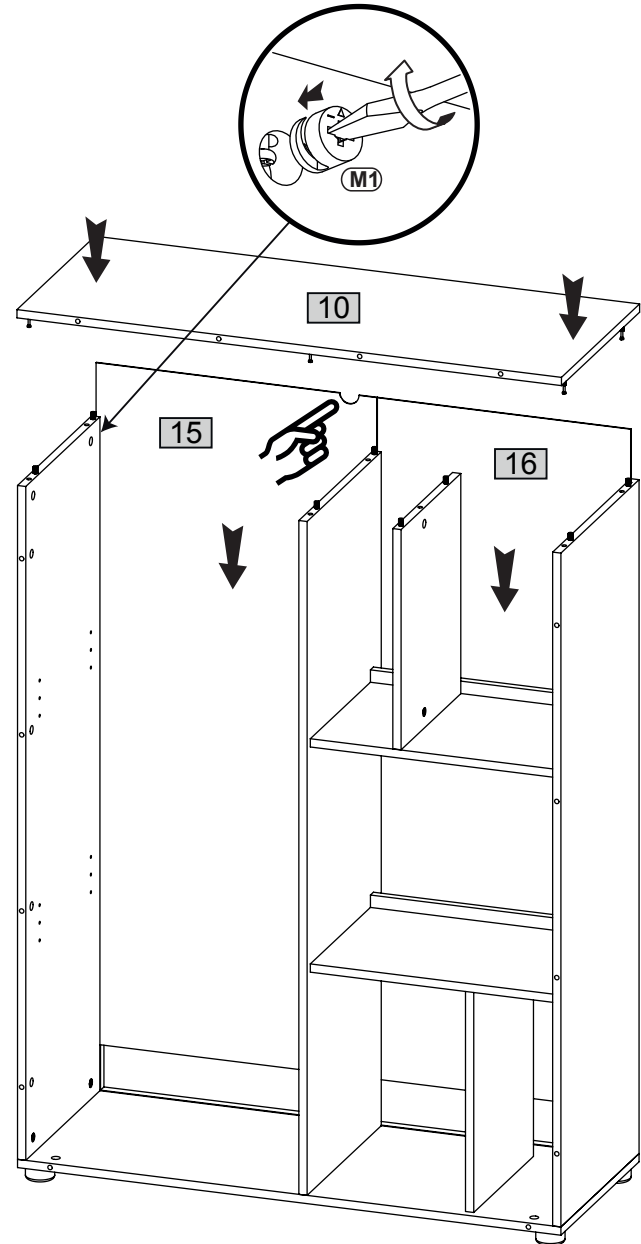

6

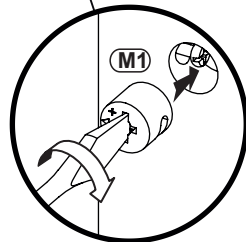
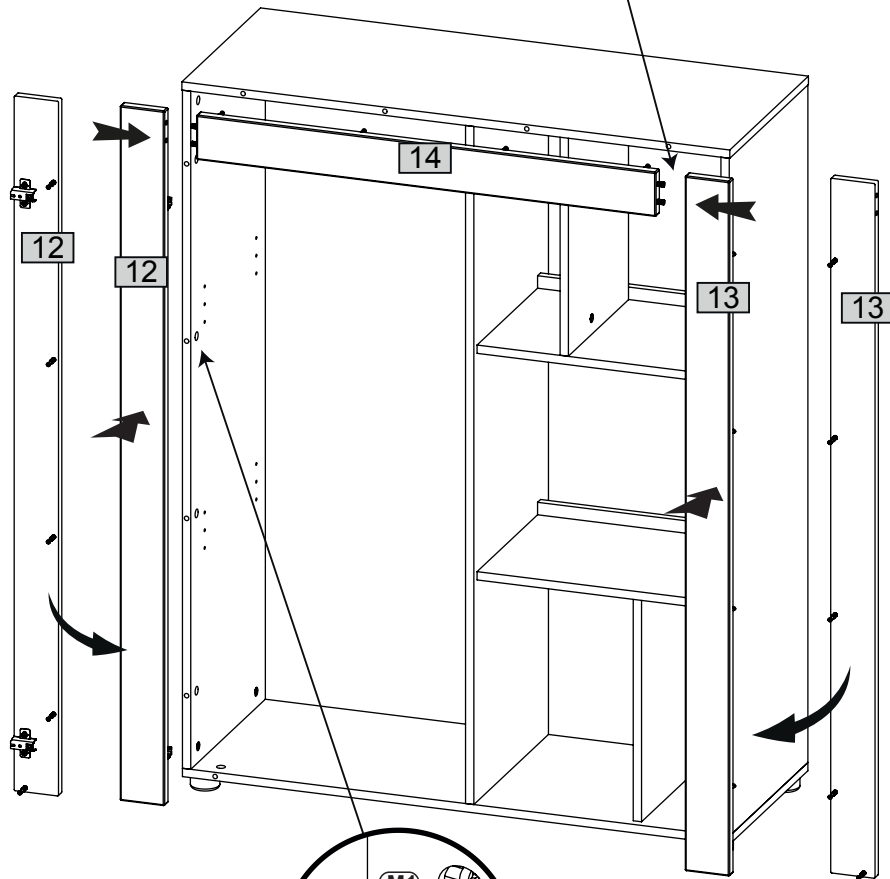
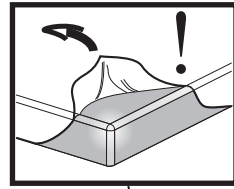

7

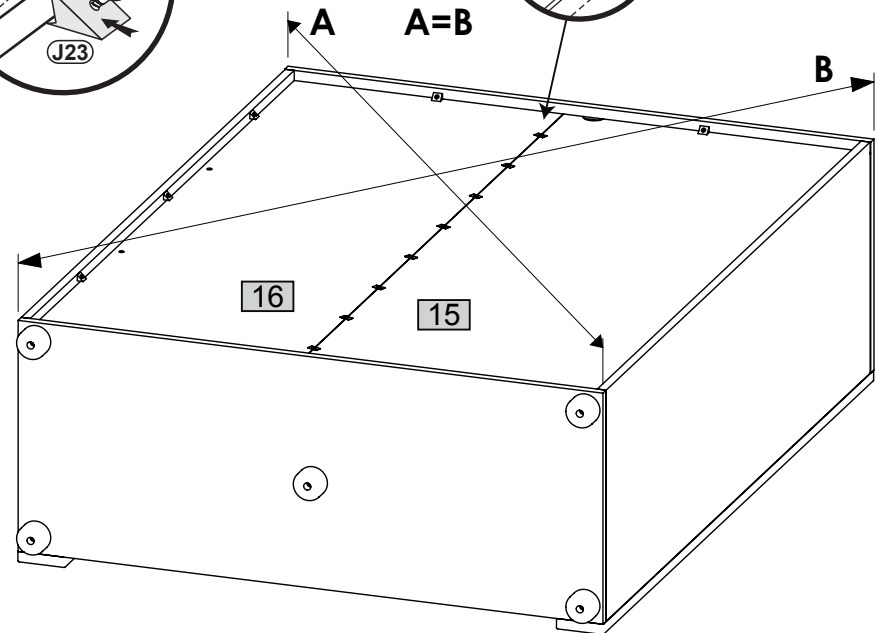
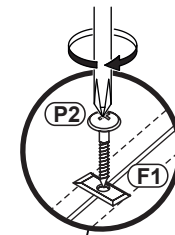
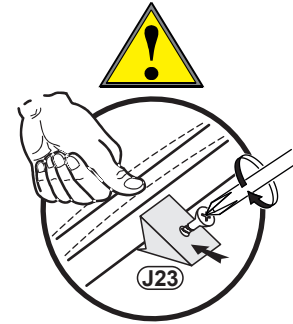
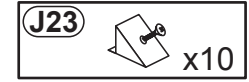
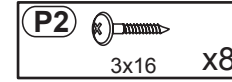
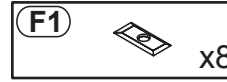



8

C2  x32
φ 20

C2  x22
φ 20

W1  x8

X19  x1

J11  x1

P13  x2
3,5x13

