

Montageanweisung / Installation instructions / Instruction de montage / Istruzioni di montaggio  
 montagehandleiding / Instrukcja montażu / Montaj talimatlar / Osszeszerelési útmutató / Nàvod k montáži /  
 Nàvod na montaž / Instrucțiune de montaj / Инструкция по монтажу / Montaj talimatina / Monteringsanvisningar  
 Upute za montažu / Instrucciones de Montaje / Navodila za montažo

# PRIMO/LINE

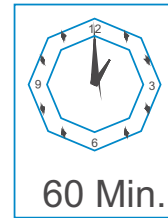
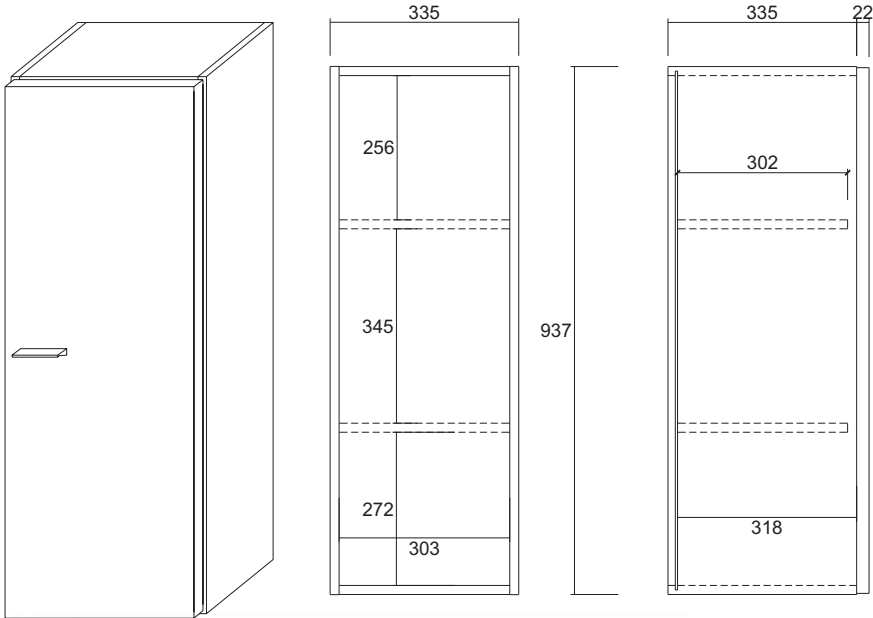
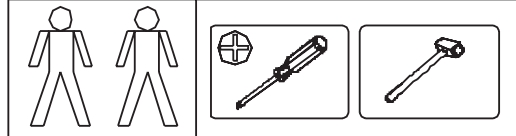

Total Kollis 1 Stuecke  
 Total colli 1 pieces  
 Numero total des colis: 1  
 Colli totali 1  
 Totaal 1 colli's  
 Razem sztuk 1  
 Toplam parçalar 1  
 Celkem balíčky 1  
 Teljes csomag 1  
 Celkom balíčky 1  
 количество Всего 1  
 Total colete 1  
 Totalt antal kollin 1  
 Ukupno koleta 1  
 Bultos Totales 1  
 Skupno število paketov 1

**D** Bitte lesen Sie diese Montageanleitung gut durch, da wir für Fehler, die durch falsche Montage entstehen, keine Haftung übernehmen!

**GB** Please read these installation instructions through carefully as we cannot accept any liability for faults occurring as a result of incorrect installation!

**CZ** Přečtěte si prosím pozorně tento návod k montáži, aby jste předešli chybám vzniklých špatnou monzáži, za které neručíme!

**F** Veuillez lire attentivement cette notice de montage, car nous déclinons toute responsabilité en cas d'erreurs découlant d'un montage erroné !

**I** Prego leggere attentamente le istruzioni per il montaggio, poiché decliniamo qualsiasi responsabilità per difetti derivanti da un montaggio errato

**S** Läs monteringsanvisningarna noggrant. Vi avsäger oss allt ansvar för defekter som uppstår p.g.a. felaktig montering.

**HR** Pažljivo pročitajte upute za montažu, jer otklanjamo svaku odgovornost za pogreške nastale uslijed pogrešne montaže.

**SLO** Prosimo, da pozorno preberete navodila za montažo, saj zavračamo vsakršno odgovornost za napake, ki bi nastale zaradi napačne montaže.

**NL** Leest u alstublieft deze montagehandleiding goed door, voor fouten door verkeerde montage zijn wij niet verantwoordelijk.

**PL** Proszę uważnie zapoznać się z instrukcją montażu, ponieważ nie ponosimy odpowiedzialności za niewłaściwy montaż.

**HU** Kérjük, olvassa el figyelmesen ezt az összeszerelési útmutatót, mert a helytelen összeszerelésből a dódó hibákért nem vállalunk felelősséget!

**SK** Prosíme, dobre prečítajte si tento návod na montáž, pretože nepreberáme žiadne ručenie za chyby, ktoré vzniknú na základe chybnej montáže!

**RO** Vă rugăm să citiți cu atenție aceste instrucțiuni de montaj deoarece nu preluăm garanția pentru defecte ce apar datorită unui montaj incorect!

**RUS** Пожалуйста, внимательно ознакомьтесь с данной инструкцией по монтажу, поскольку мы не несем ответственности за ошибки, причиной которых является неправильный монтаж.

**TU** İlkonce kullanma klavuzunu iyi okuyun, yalnız montaj yapasanız bunun sorumlusu biz degiliz.

**E** Se ruega leer con atención las instrucciones de montaje debido a que declinamos cualquier responsabilidad por defectos derivados de un montaje erróneo

LC S.p.A  
 Via del Piano s.n  
 61030 Isola del Piano (PU)  
 Italia

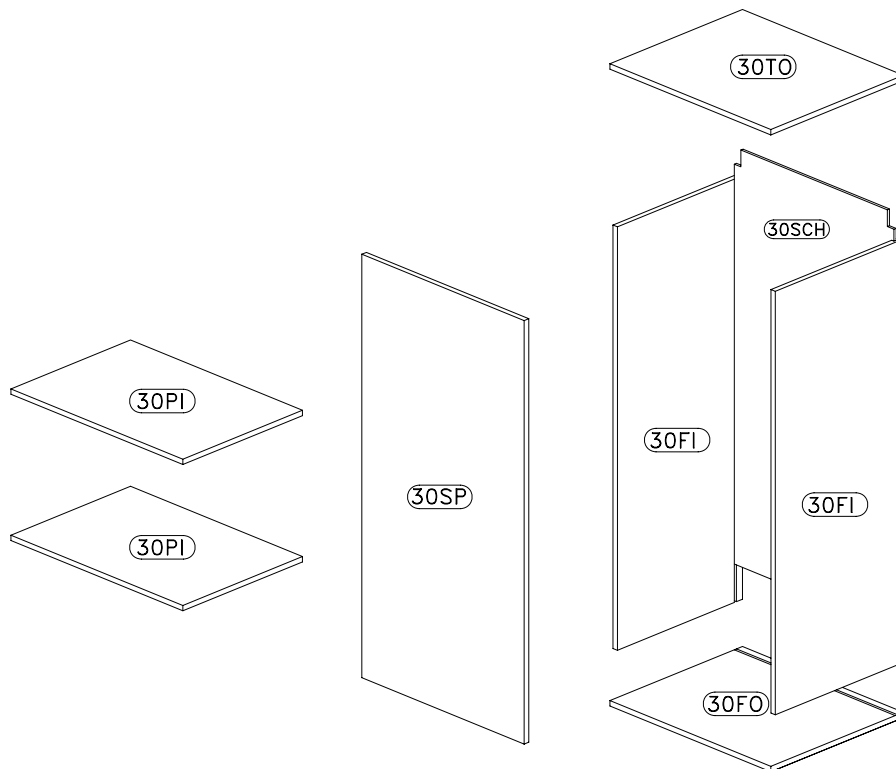

**709042-30CF**

**A** **x10** **P**

**B** **x8** **P11**  
8x30 mm.

**C** **x8** **P12**  
Ø16 mm.

**D** **x8** **R**

**L** **x4** **P4**  
4x30 mm.

**P** **x2**

**R** **x8**

**P4** **x1**  
**709049-30CRE**

**709042-30CC**

**L2** **x4**  
4x16 mm.

**N1** **x2**

**O** **x2**

**700916-12ATT**

**P5** **x1**

**P6** **x1**

**709042-30CM**

**T27** **x2**  
4x27,5mm.

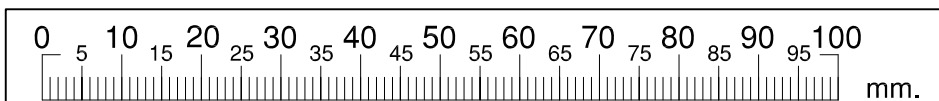

**S6** **x1**  
32 mm.

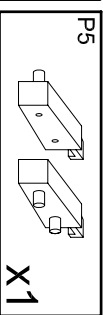
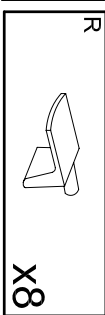
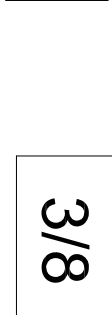
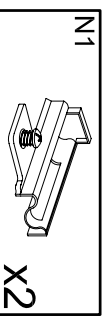
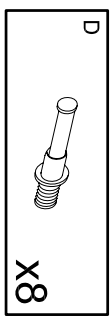
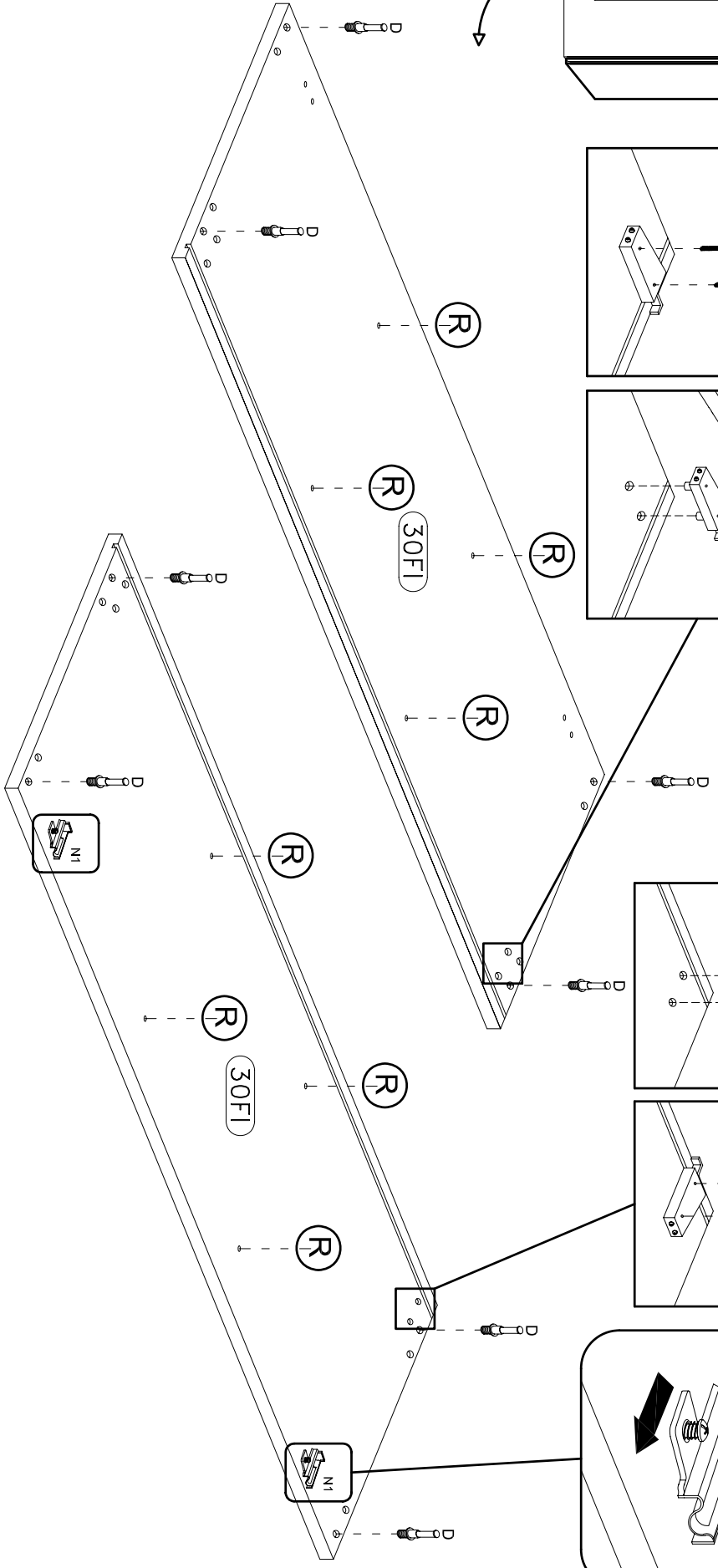
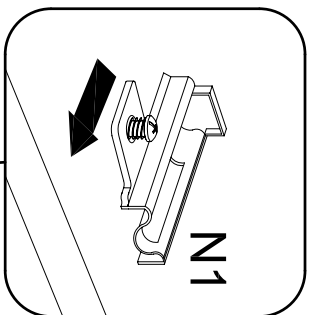
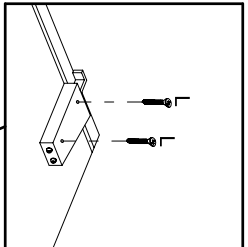
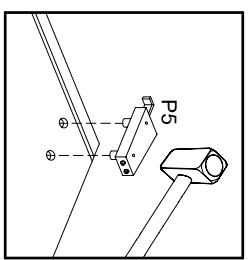
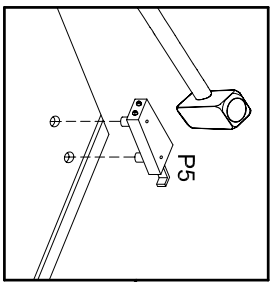
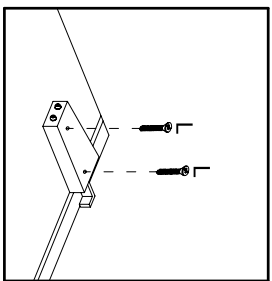
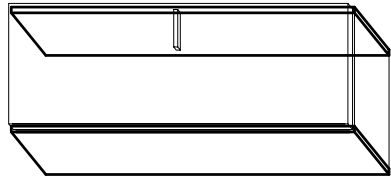
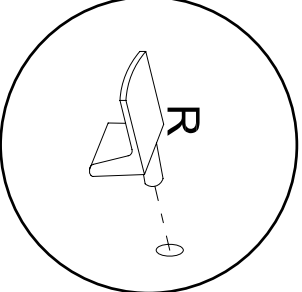

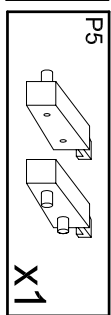
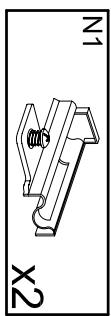
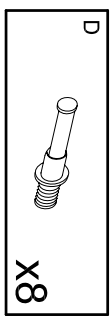
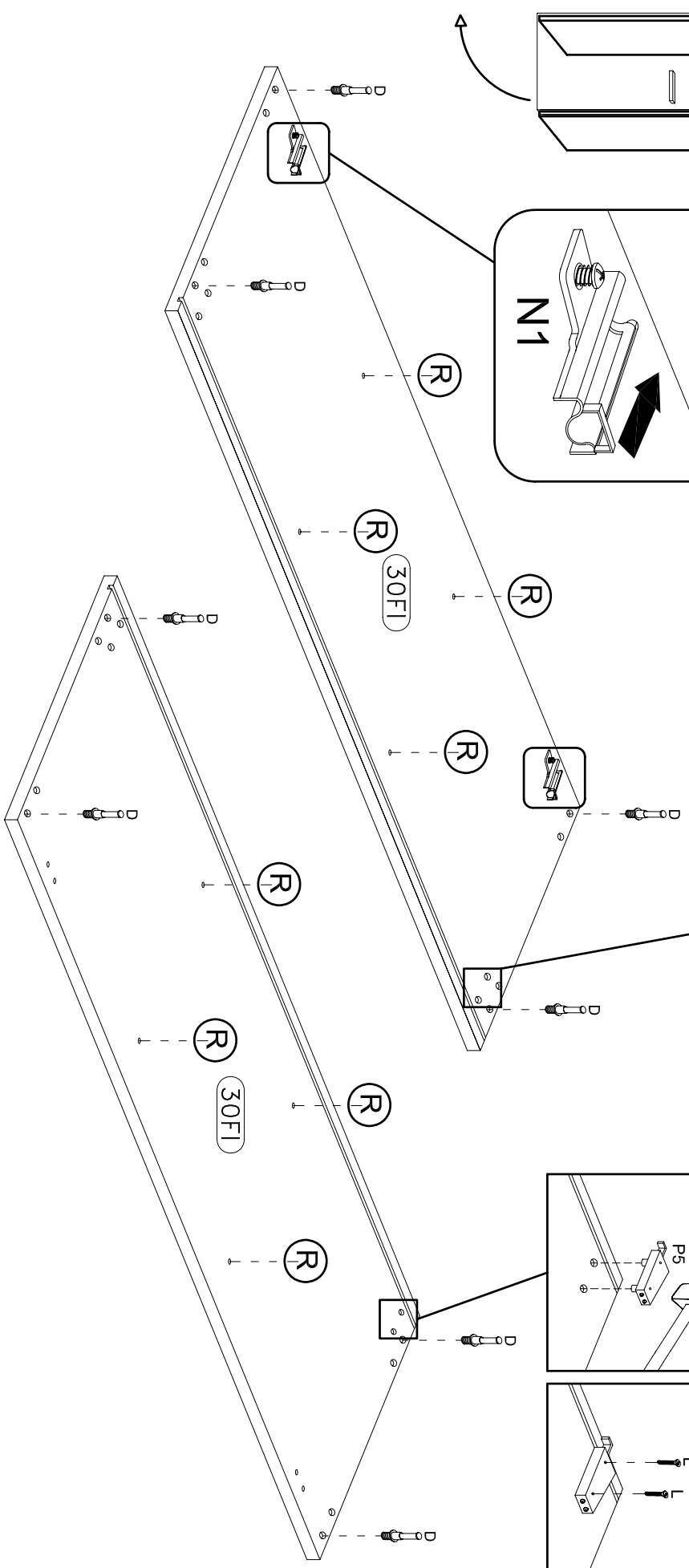
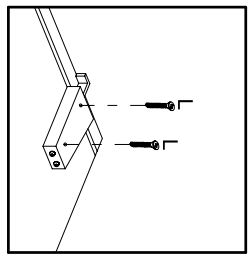
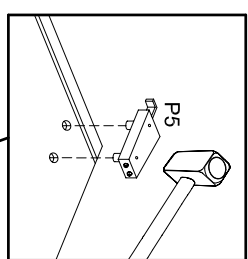
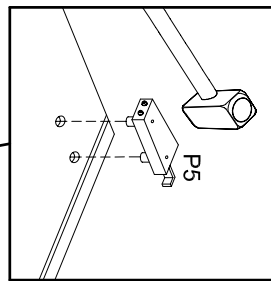
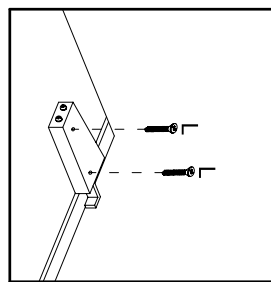
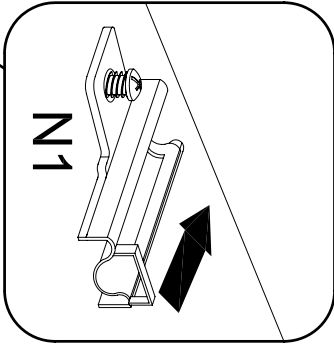
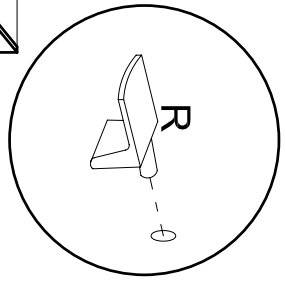



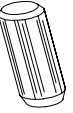

# 2

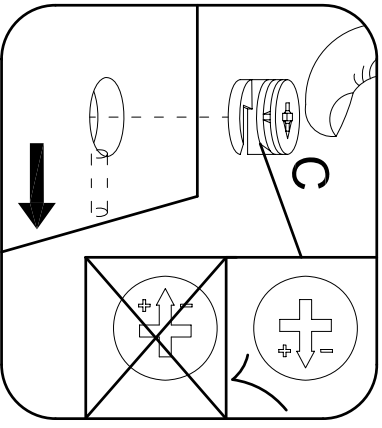
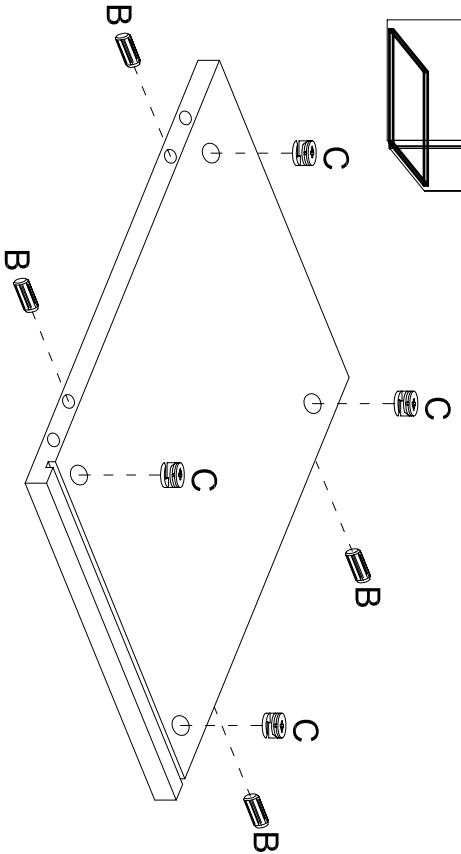
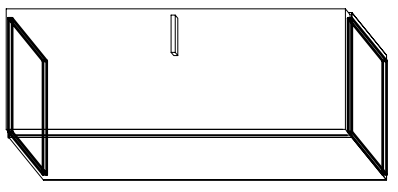
- B**  8x30 mm. **X8**
- C**   $\varnothing$ 16 mm. **X8**



# 3

- P12**   $\varnothing$ 20 mm. **X4**

# 5/8

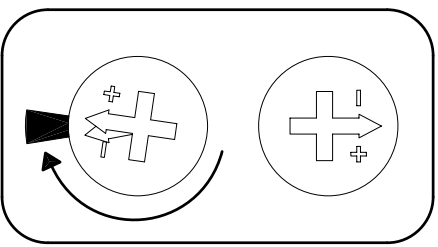
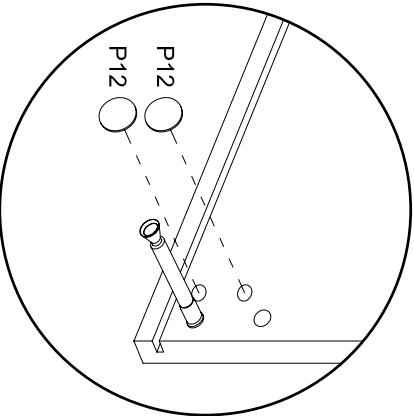
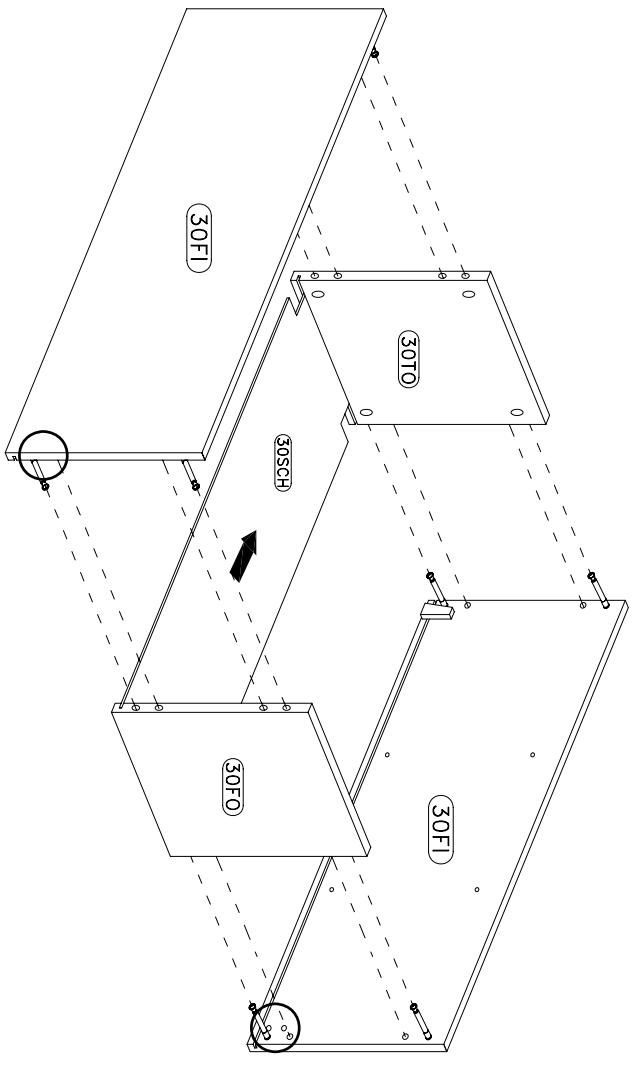

# 4

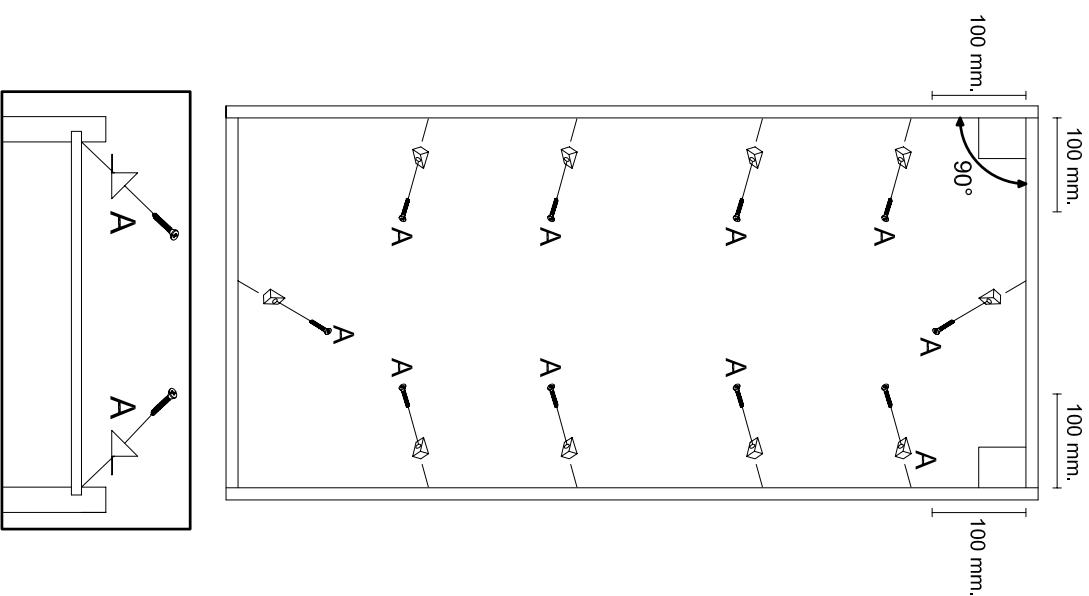
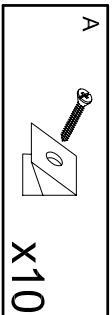

# 5

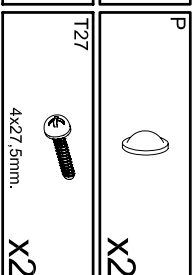
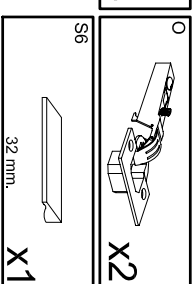

# 6/8

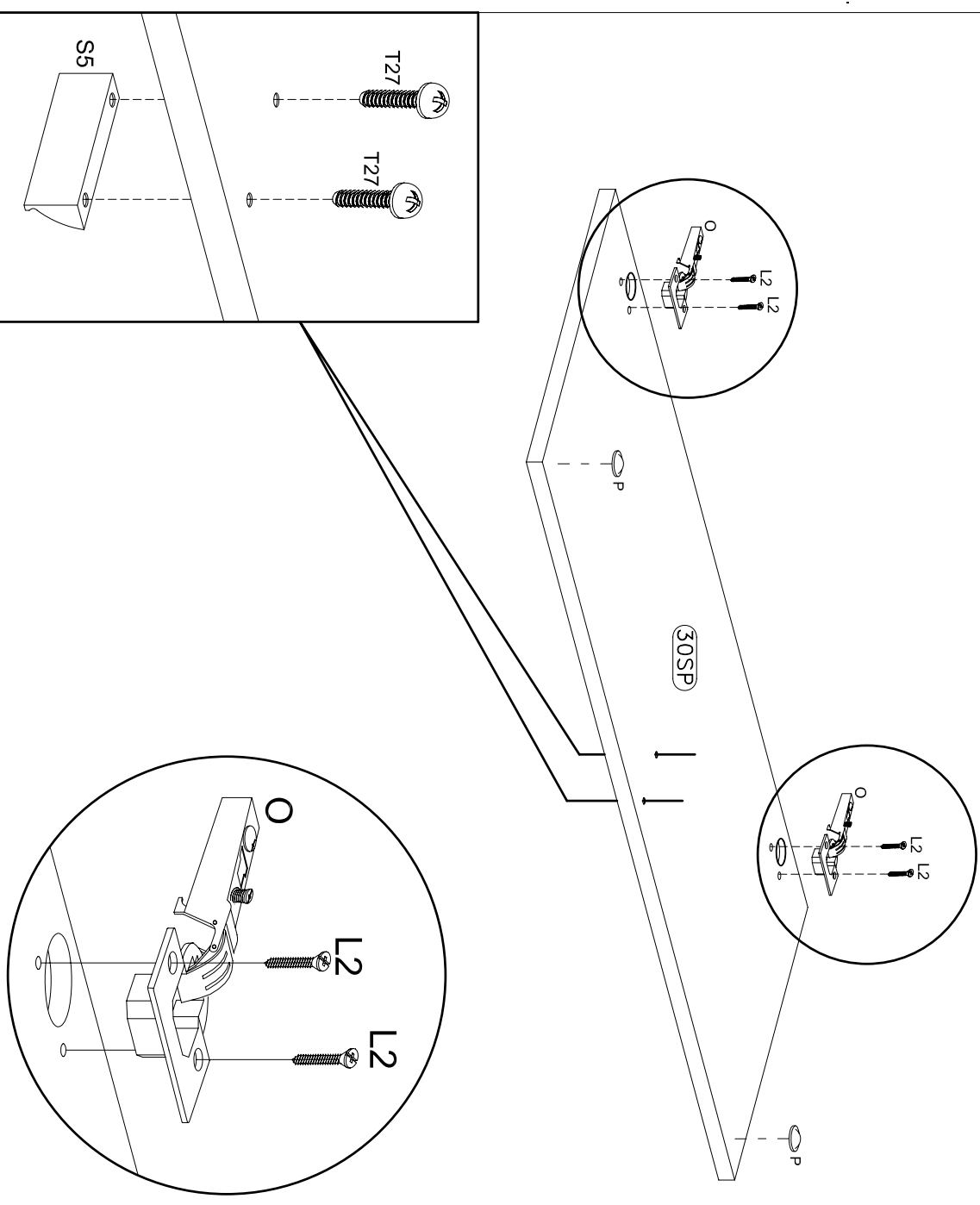

6

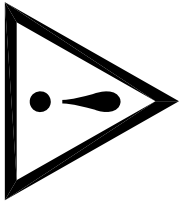

Cher client,

l'installation des meubles suspendus doit être effectuée par un personnel compétent.

Les fishers ne sont pas inclus dans la quincaillerie.

Choisir les types des fishers pour le fixage apte au mur.

S'assurer de l'adéquation du mur pour support sûr du meuble

Dear Customer

The assembling of the hanging elements must be done by a competent staff.

The fishers are not included in the hardware package.

Choose the fisher more suitable to the type of the wall.

Ensure the suitability of the wall for a secure support of the hanging element.

Sehr geehrter Kunde, die Montage der Haengeelemente muss von Fachpersonal ausgefuehrt werden! Bitte verwenden Sie eigene, der Beschaffenheit der Wand entsprechende Duebel. Zu Ihrer eigenen Sicherheit legen wir dem Beschlagbeutel keine Fischerduebel bei.

Gentile Cliente

Il montaggio dei pensili deve essere effettuato da personale competente.

I tasselli di fissaggio non sono compresi nella ferramenta.

Scegliere il tipo di tassello per il fissaggio più adatto alla tipologia di muro.

Assicurarsi l'idoneità della parete per un sostegno sicuro del pensile.

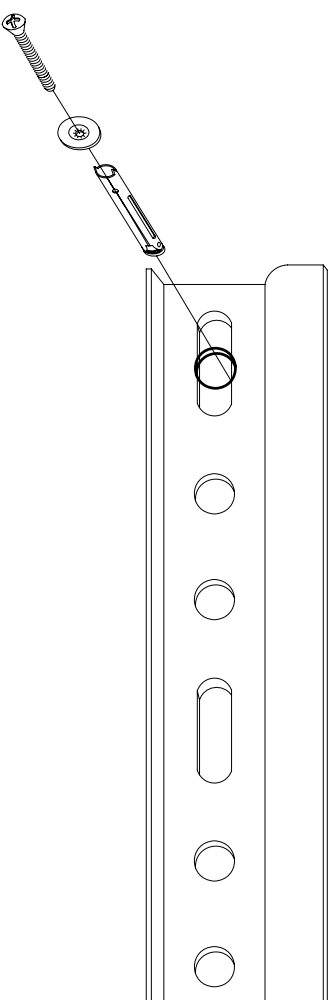
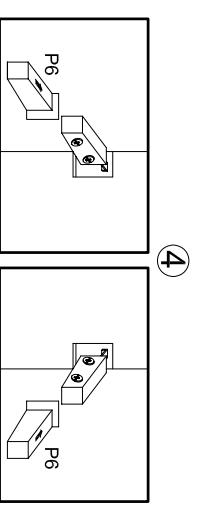
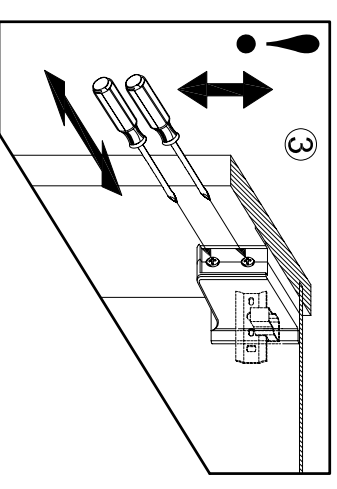
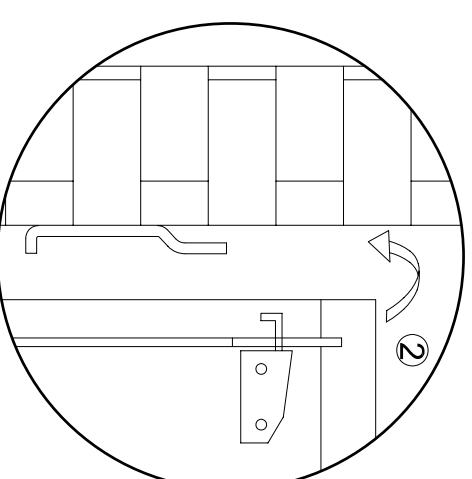
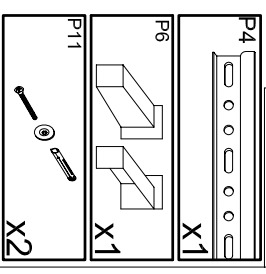
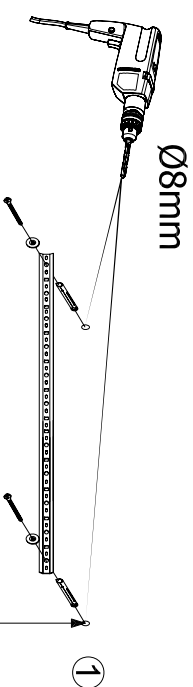

7

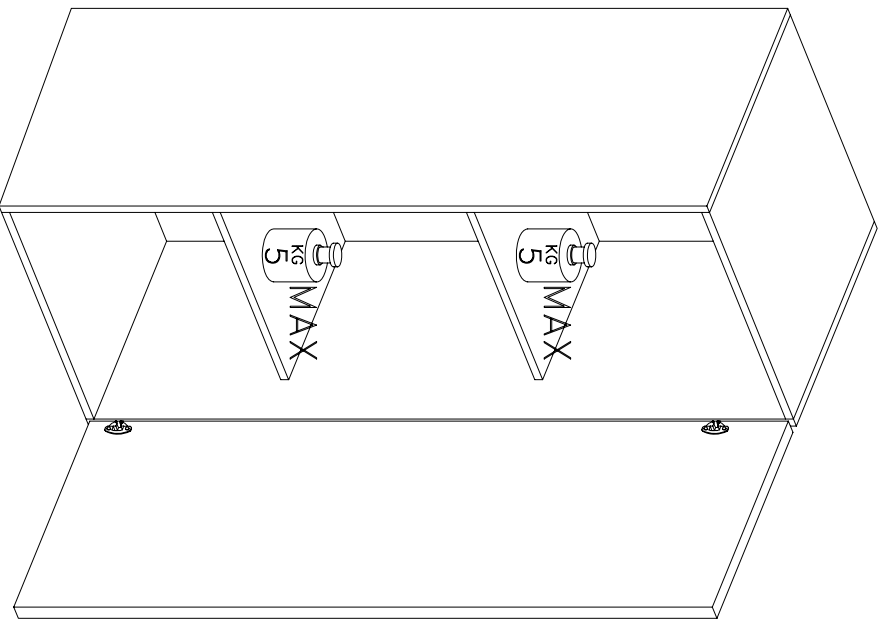
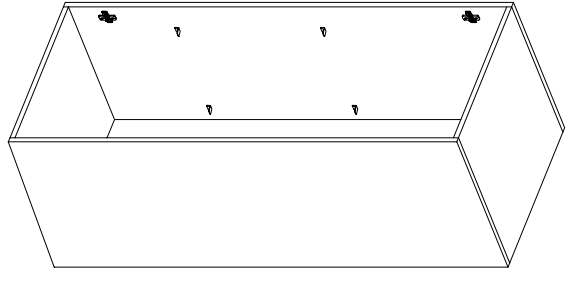
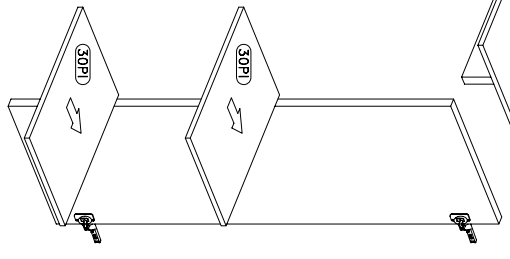
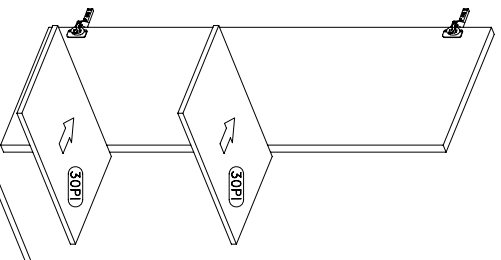
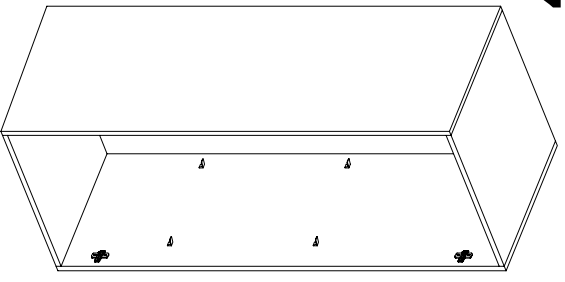

CLICK!!!

