

A	B	C (mm)		D
1	S263-1001	599	168	1/1
2	S263-1002	567	168	1/1
3	S263-1008	783	168	1/1
4	S263-1009	401	168	1/1
5	S263-2005	1200	600	1/1
6	S263-2006	1200	600	1/1
7	S263-4006	1207	100	1/1
8	S263-4007	585	100	1/1

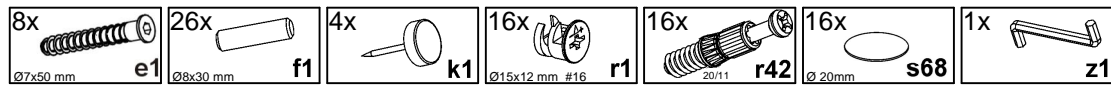

1

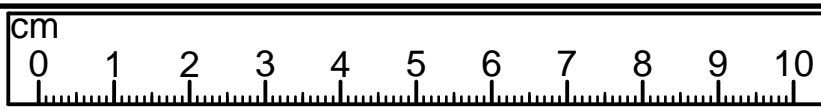
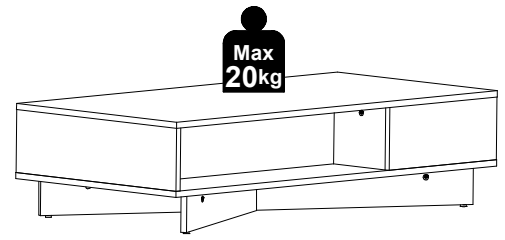
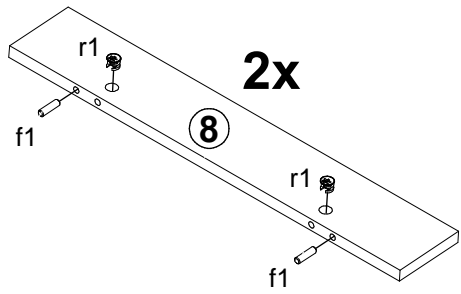
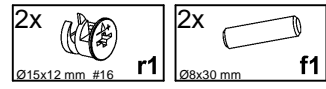
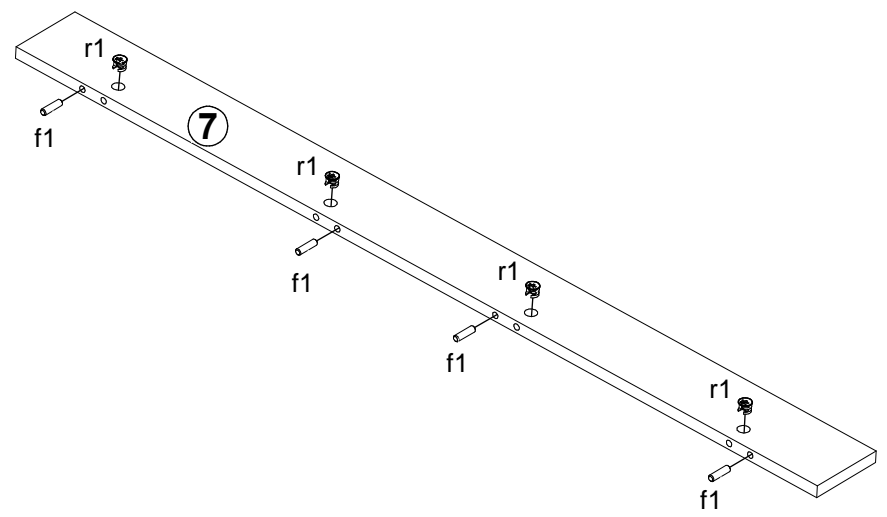
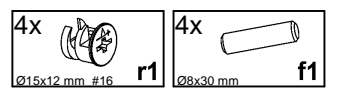
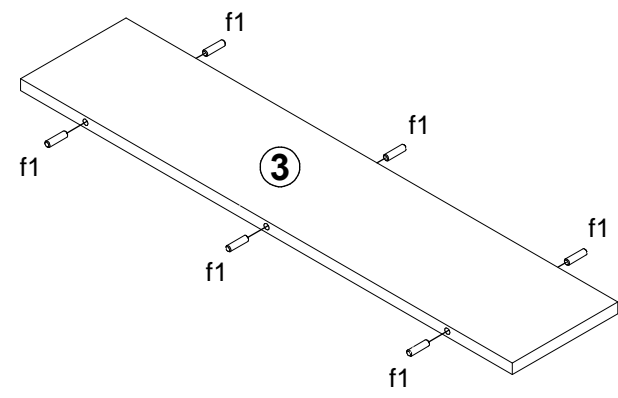
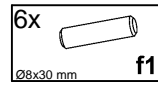
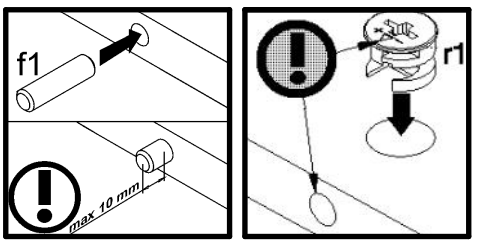
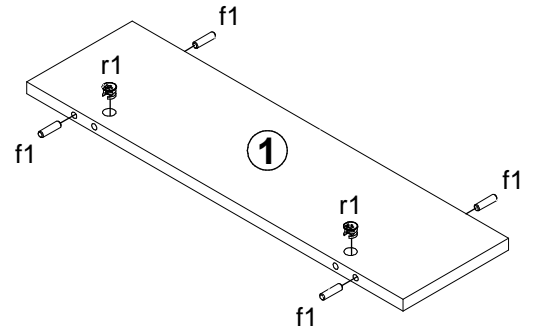
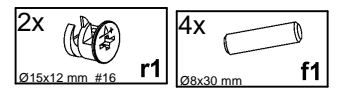
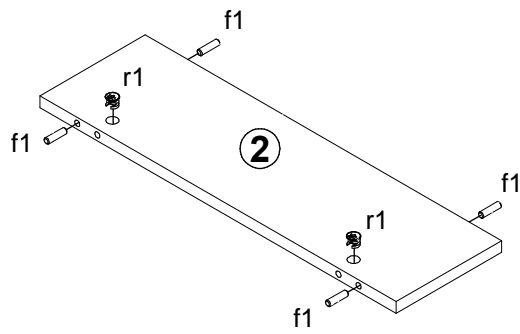
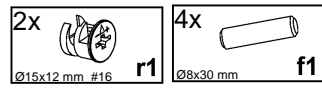
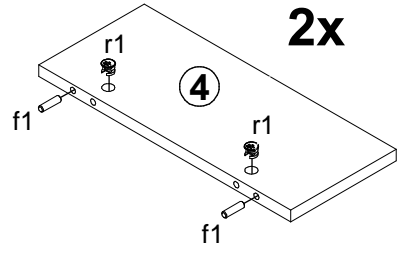
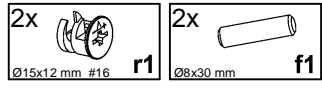

A

S263-LAW/3/12

4 / 6

1

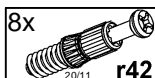
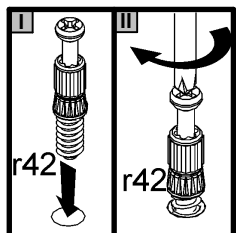
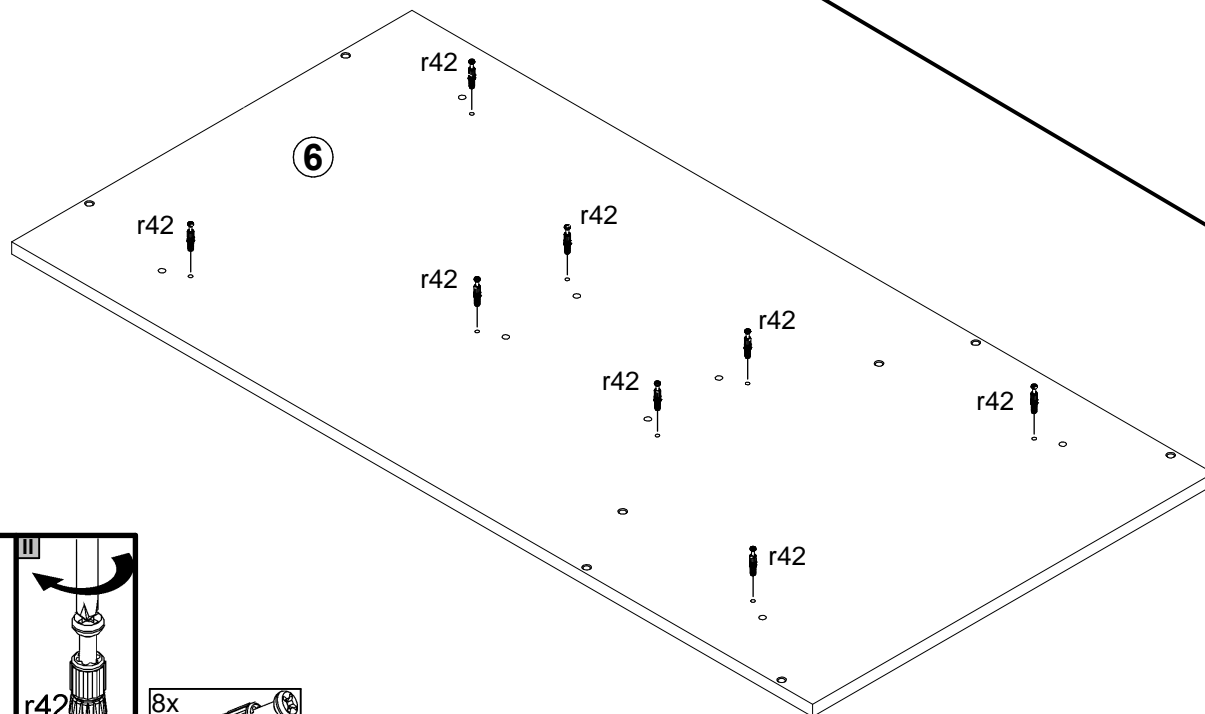
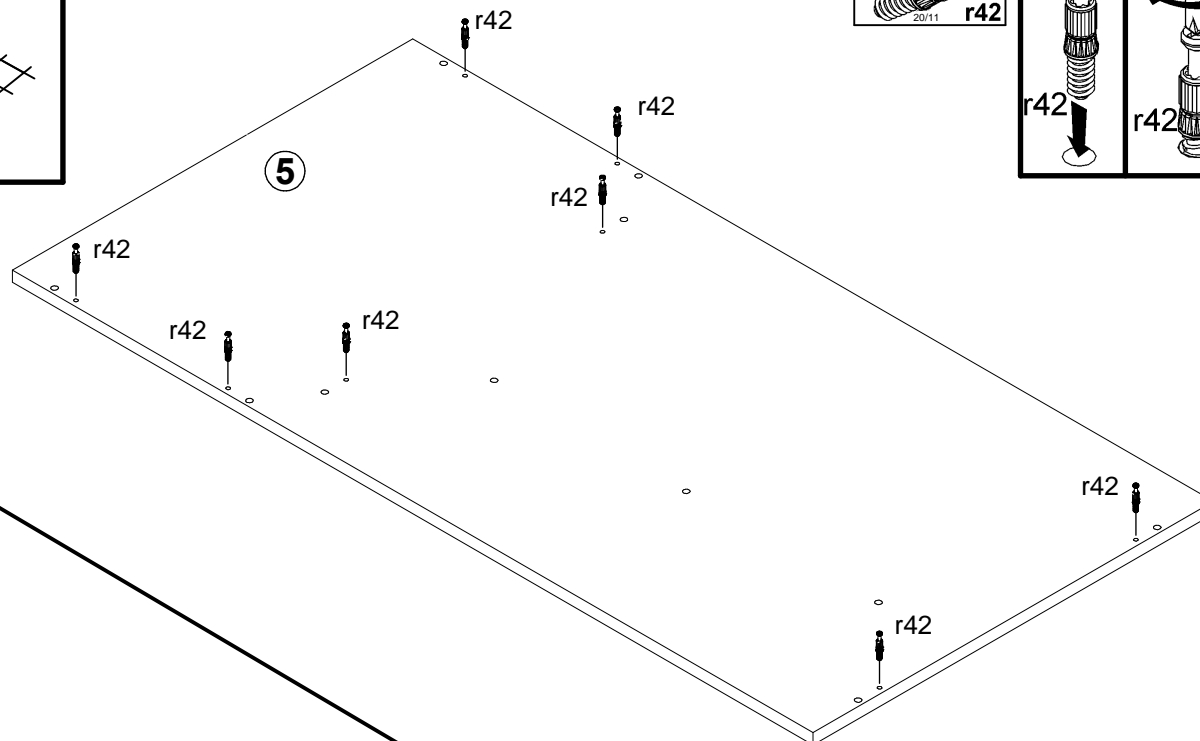
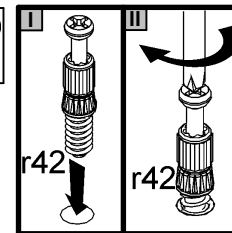
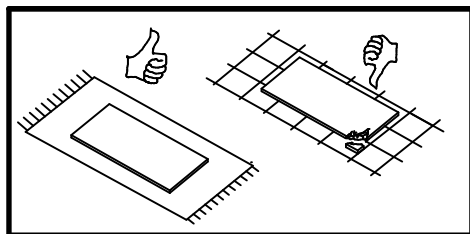



2

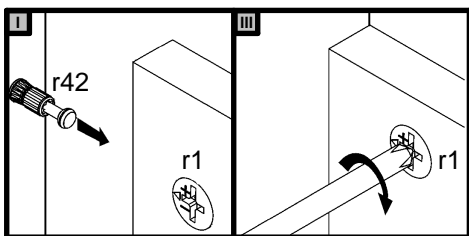
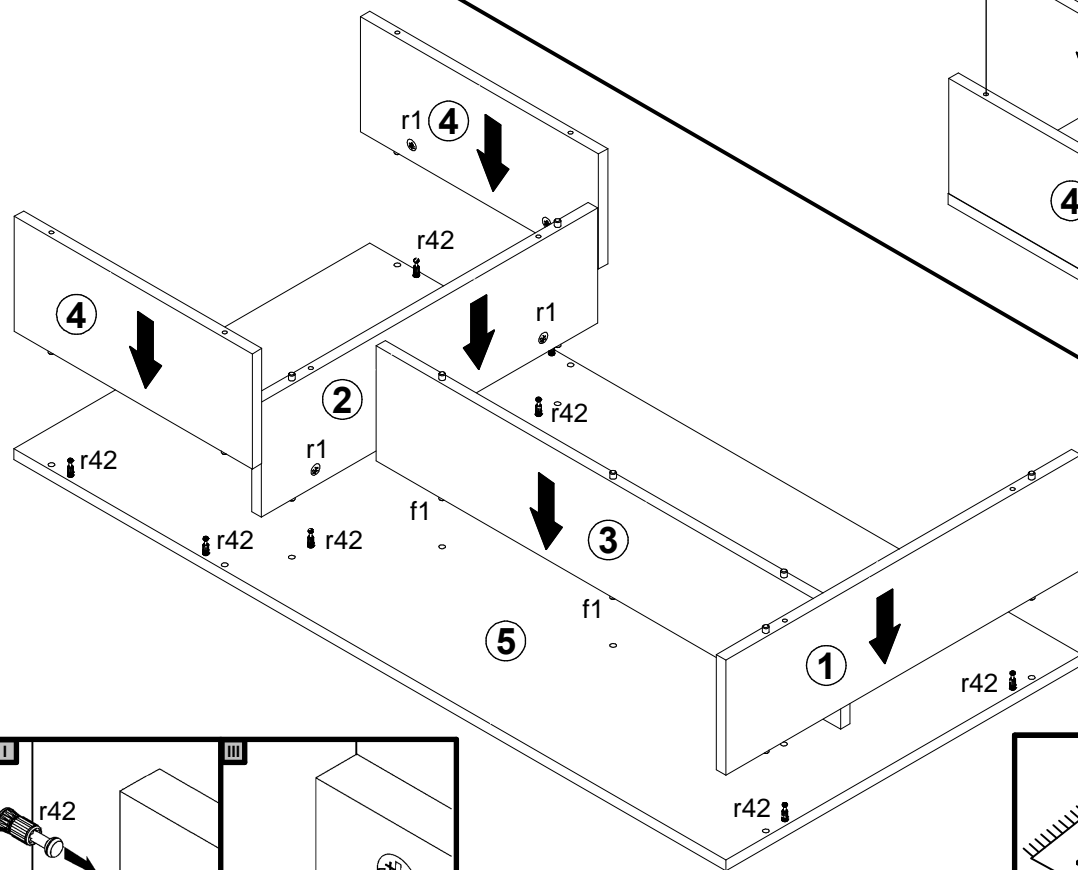

3

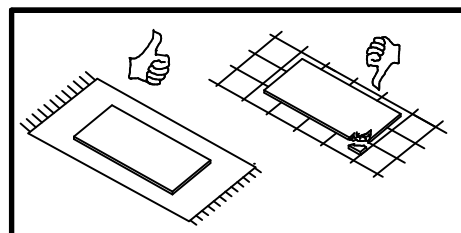
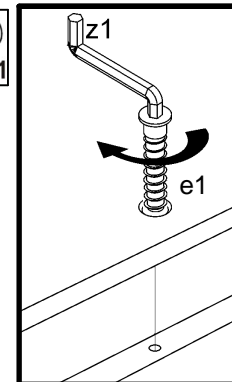
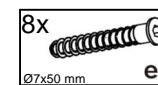
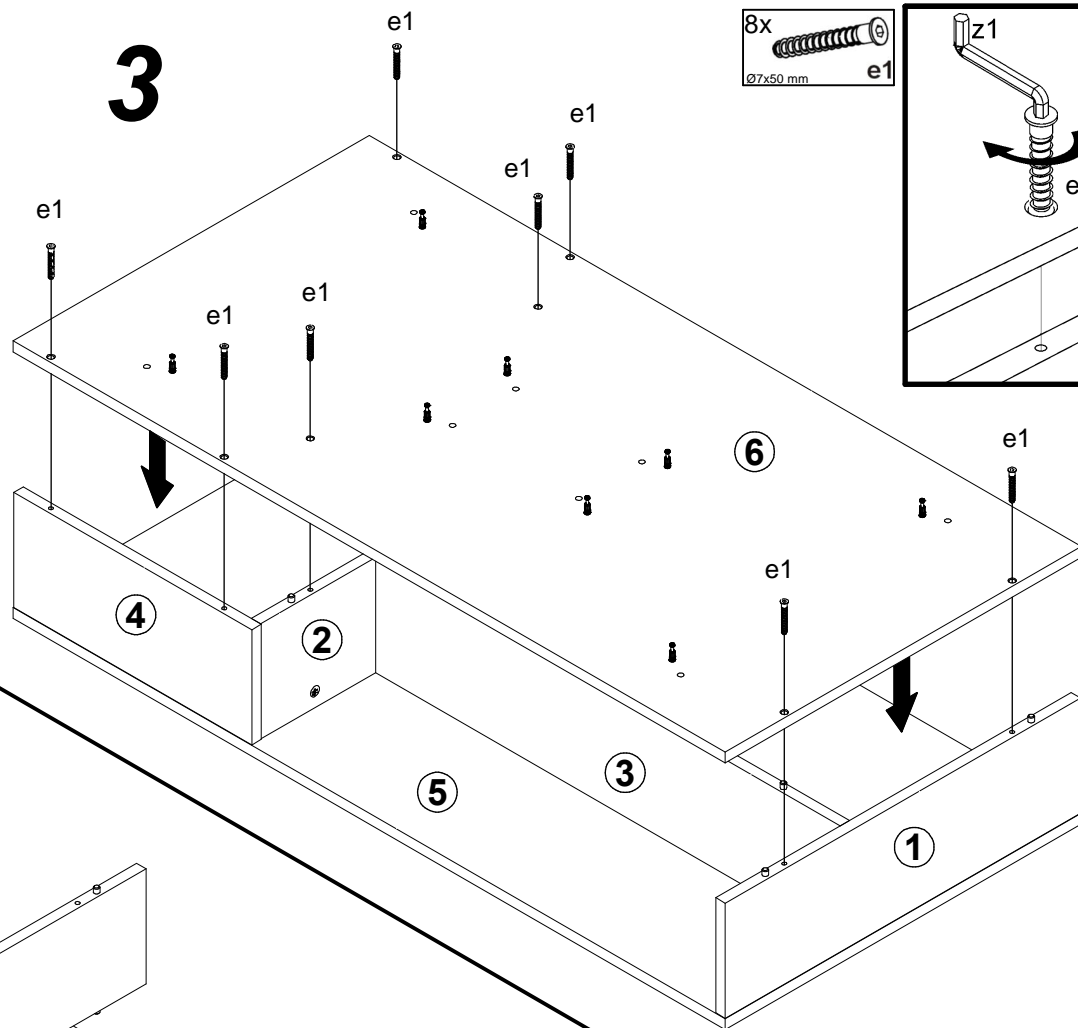

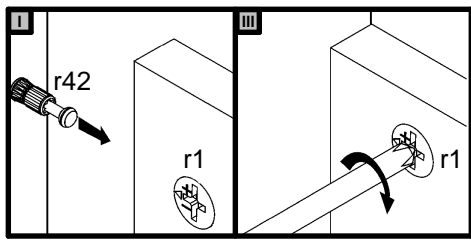
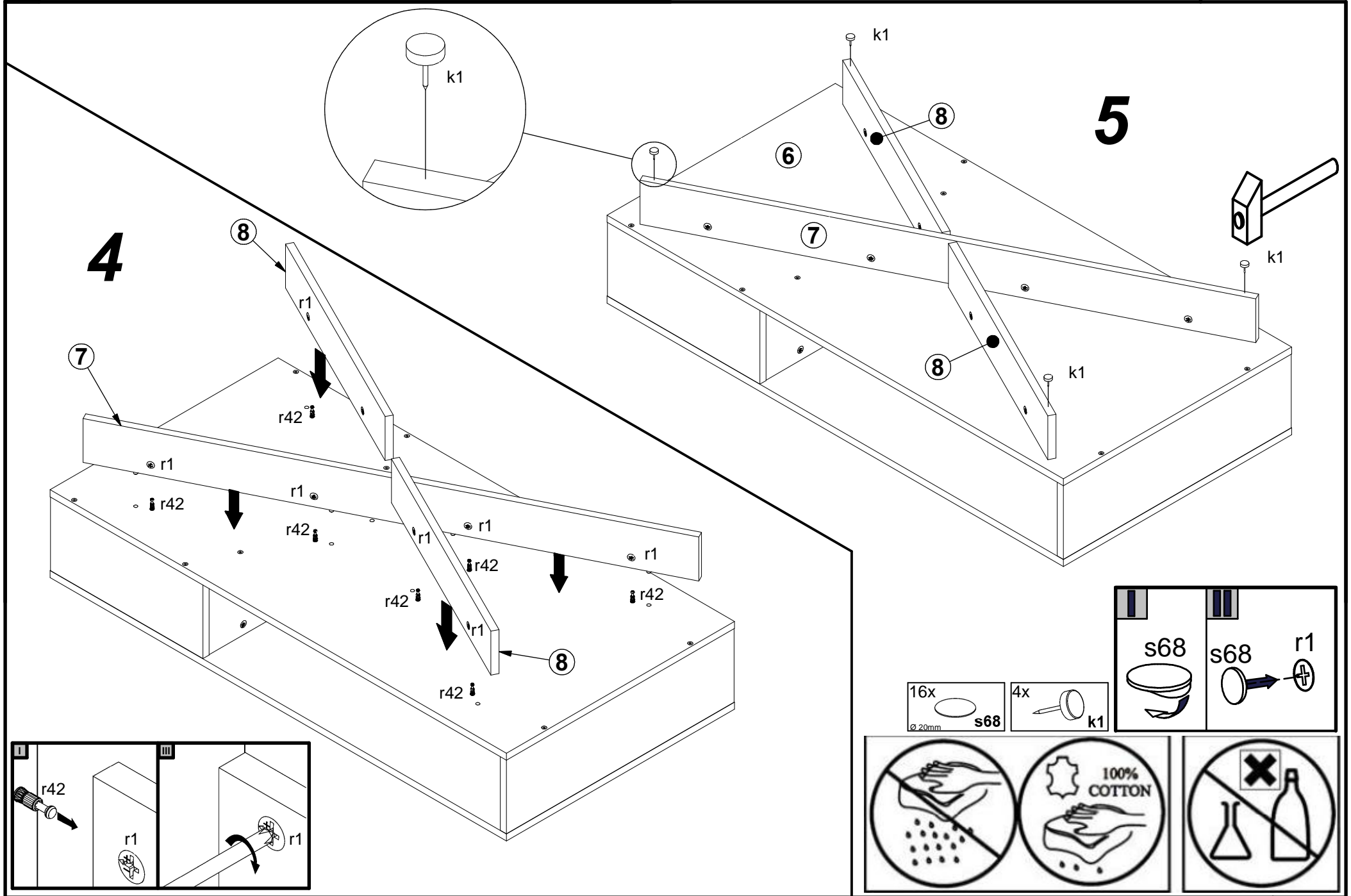

16x  
Ø 20mm  
s68

4x  
k1

