

Montageanweisung / Installation instructions / Instruction de montage / Istruzioni di montaggio
 montagehandleiding / Instrukcja montażu / Montaj talimatlar / Osszeszerelési útmutató / Návod k montáži /
 Návod na montáž / Instrucțiune de montaj / Инструкция по монтажу / Montaj talimatina

YANNICK

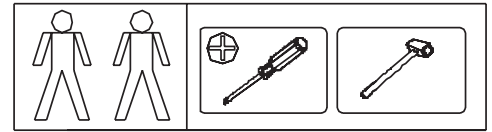

10404200
10404210

LC s.p.a 61030

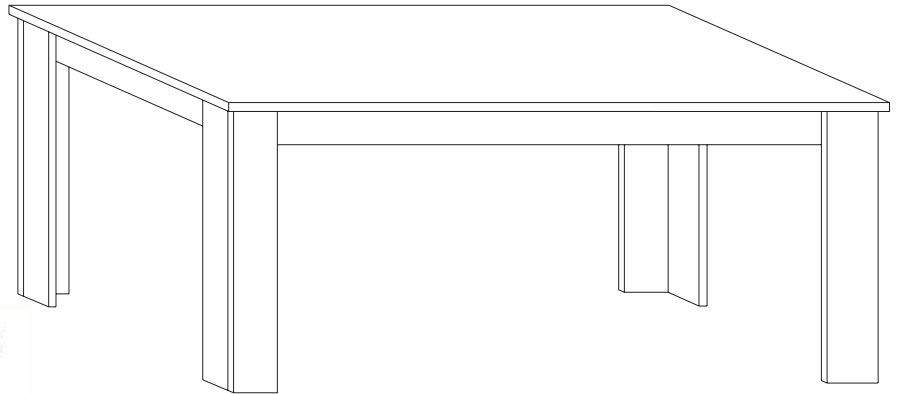

D Bitte lesen Sie diese Montageanleitung gut durch, da wir für Fehler, die durch falsche Montage entstehen, keine Haftung übernehmen!

GB Please read these installation instructions through carefully as we cannot accept any liability for faults occurring as a result of incorrect installation!

CZ Přečtěte si prosím pozorně tento návod k montáži, aby jste předešli chybám vzniklých špatnou montáží, za které neručíme!

F Veuillez lire attentivement cette notice de montage, car nous déclinons toute responsabilité en cas d'erreurs découlant d'un montage erroné !

I Prego leggere attentamente le istruzioni per il montaggio, poiché decliniamo qualsiasi responsabilità per difetti derivanti da un montaggio errato

NL Leest u alstublieft deze montagehandleiding goed door, voor fouten door verkeerde montage zijn wij niet verantwoordelijk.

PL Proszę uważnie zapoznać się z instrukcją montażu, ponieważ nie ponosimy odpowiedzialności za niewłaściwy montaż.

HU Kérjük, olvassa el figyelmesen ezt az összeszerelési útmutatót, mert a helytelen összeszerelésből a dódó hibáért nem vállalunk felelősséget!

SK Prosíme, dobre prečítajte si tento návod na montáž, pretože nepreberáme žiadne ručenie za chyby, ktoré vzniknú na základe chybnej montáže!

RO Vă rugăm să citiți cu atenție aceste instrucțiuni de montaj deoarece nu preluăm garanția pentru defecte ce apar datorită unui montaj incorrect!

RUS Пожалуйста, внимательно ознакомьтесь с данной инструкцией по монтажу, поскольку мы не несем ответственности за ошибки, причиной которых является неправильный монтаж.

TU İlkonce kullanma klavuzunu iyi okuyun, yalnızca montaj yapmanızın sorumlusu biz değiliz.

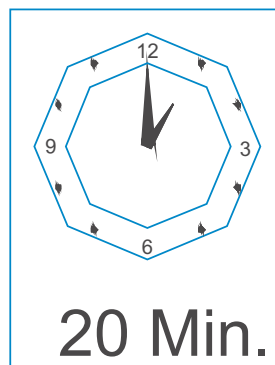

Total Kollis 2 Stuecke
 Total colli 2 pieces
 Numero total des colis:2
 Colli totali 2
 Totaal 2 colli's
 Razem sztuk 2
 Toplam parçalar 2
 Celkem balíčky 2
 Teljes csomag 2
 Celkom balíčky 2
 количество Всего 2
 Total colete 2

ONDERDELEN LYST-SERVICEKARTE-FORMULAIRE DEMANDES SAV-SPAREPARTS LIST-SCHEDA DI SERVIZIO

BESLAG-BESCHLAEGE - QUINCALLERIE - HARDWARE - FERRAMENTA

B

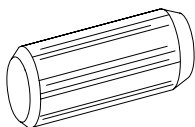

8x30 mm. **x8**

L3



4x18 mm. **x30**

P7

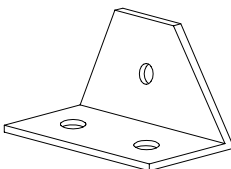

x10

L4



4.5x40 mm. **x24**

F3



x8

P13

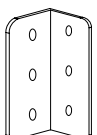

x4

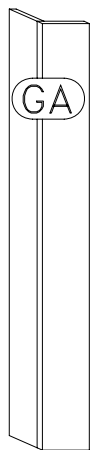
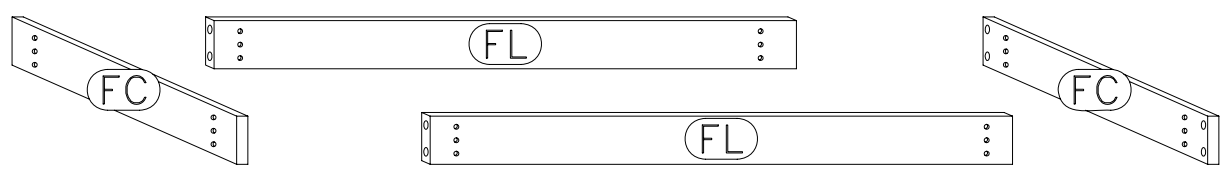
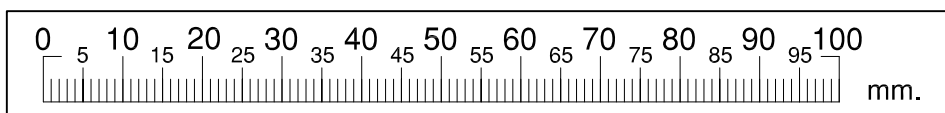

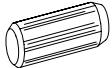

1

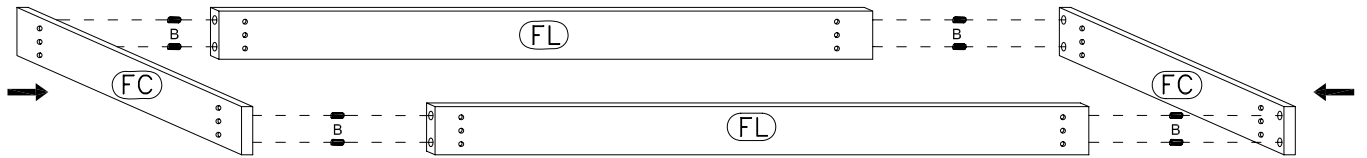
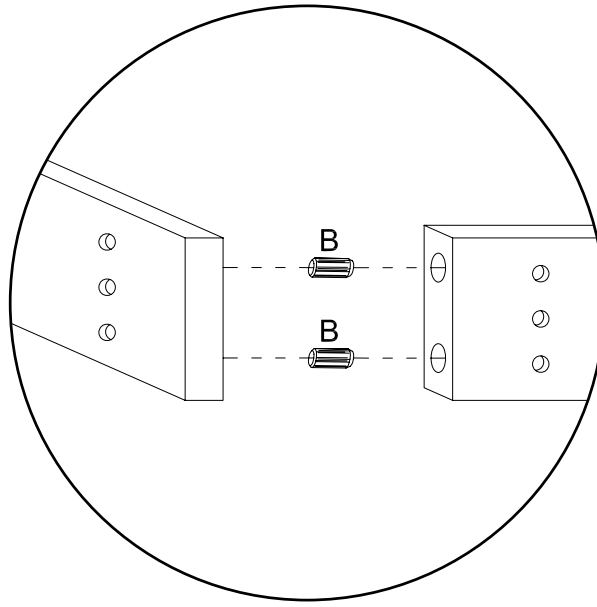
B		x8
8x30 mm.		



2

F3		x8
L4		x24 4.5x40 mm.
P13		x4

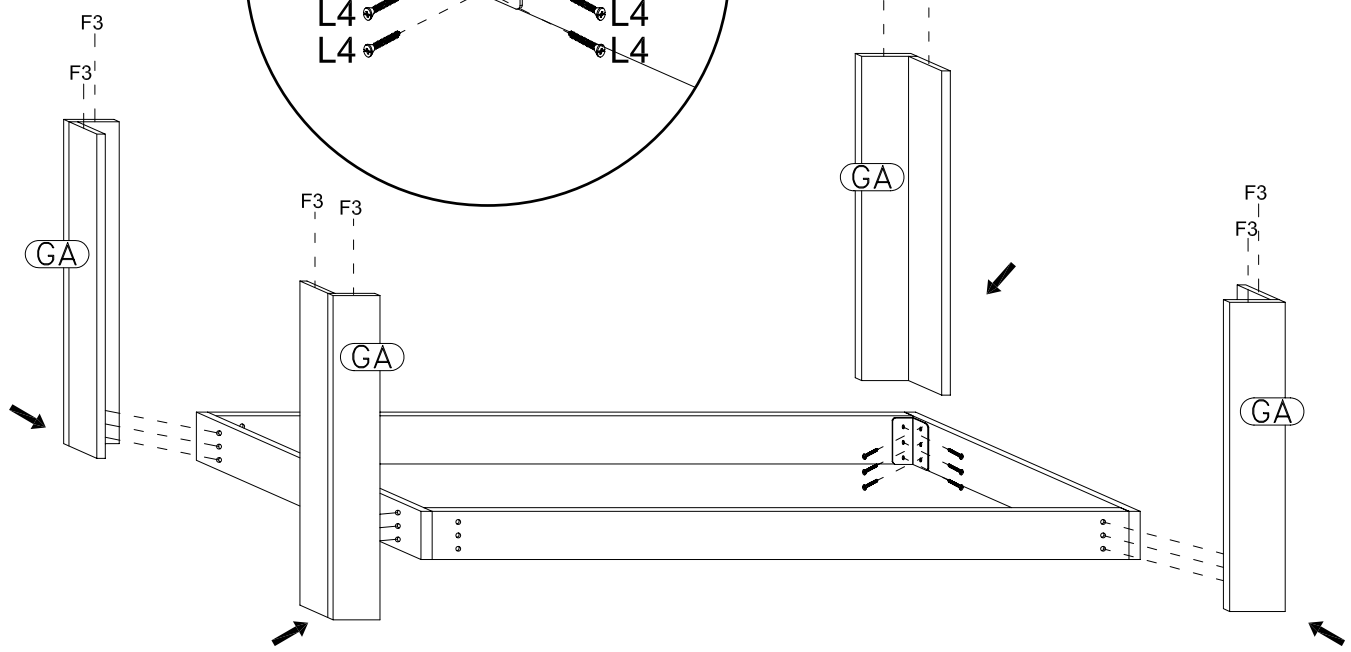
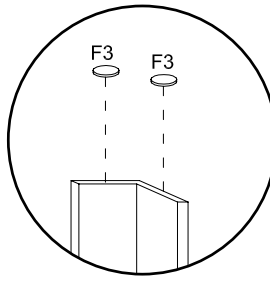
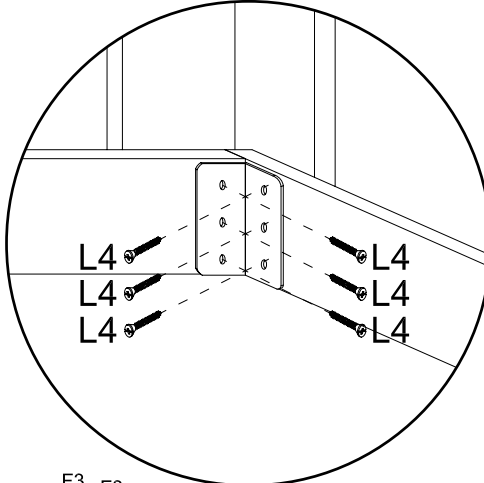

3

