

-02P2

Montageanweisung / Installation instructions / Instruction de montage / Istruzioni di montaggio
montagehandleiding / Instrukcja montażu / Montaj talimatlar / Osszeszerelési útmutató / Návod k montáži /
Návod na montáž / Instrucțiune de montaj / Инструкция по монтажу / Montaj talimatina

YANNICK

10604225

10604220

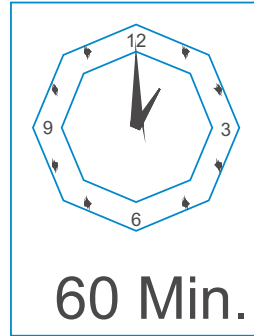
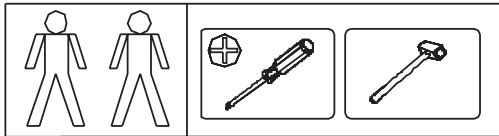

Total Kollis 2 tuecke
Total colli 2 pieces
Numero total des colis:2
Colli totali 2
Totaal 2 colli's
Razem sztuk 2
Toplam parçalar 2
Celkem balíčky 2
Teljes csomag 2
Celkom balíčky 2
количество Всего 2
Total colete 2

LC s.p.a 61030

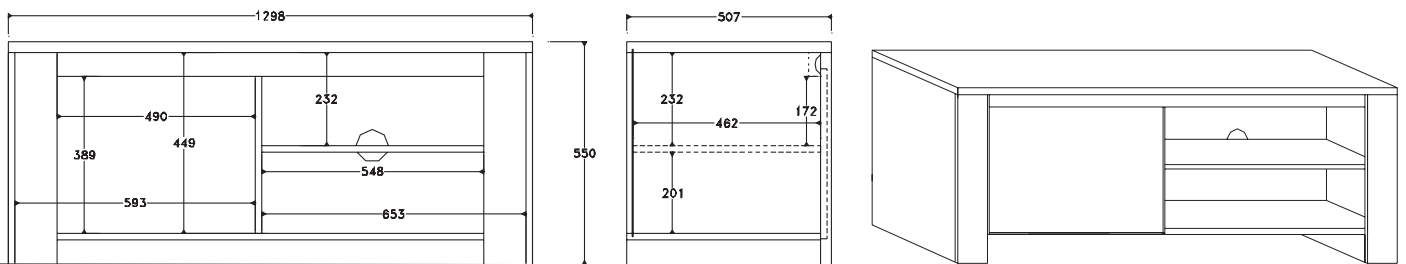

D Bitte lesen Sie diese Montageanleitung gut durch, da wir für Fehler, die durch falsche Montage entstehen, keine Haftung übernehmen!

GB Please read these installation instructions through carefully as we cannot accept any liability for faults occurring as a result of incorrect installation!

CZ Přečtěte si prosím pozorně tento návod k montáži, aby jste předešli chybám vzniklých špatnou montáží, za které neručíme!

F Veuillez lire attentivement cette notice de montage, car nous déclinons toute responsabilité en cas d'erreurs découlant d'un montage erroné !

I Prego leggere attentamente le istruzioni per il montaggio, poiché decliniamo qualsiasi responsabilità per difetti derivanti da un montaggio errato

NL Leest u alstublieft deze montagehandleiding goed door, voor fouten door verkeerde montage zijn wij niet verantwoordelijk.

PL Proszę uważnie zapoznać się z instrukcją montażu, ponieważ nie ponosimy odpowiedzialności za niewłaściwy montaż.

HU Kérjük, olvassa el figyelmesen ezt az összeszerelési útmutatót, mert a helytelen összeszerelésből a dódó hibákért nem vállalunk felelősséget!

SK Prosíme, dobre prečítajte si tento návod na montáž, pretože nepreberáme žiadne ručenie za chyby, ktoré vzniknú na základe chybnej montáže!

RO Vă rugăm să citiți cu atenție aceste instrucțiuni de montaj deoarece nu preluăm garanția pentru defecte ce apar datorită unui montaj incorect!

RUS Пожалуйста, внимательно ознакомьтесь с данной инструкцией по монтажу, поскольку мы не несем ответственности за ошибки, причиной которых является неправильный монтаж.

TU İlkonce kullanma klavuzunu iyi okuyun, yalnız montaj yaparsanız bunun sorumlusu biz degiliz.

S E R V I C E K A R T E

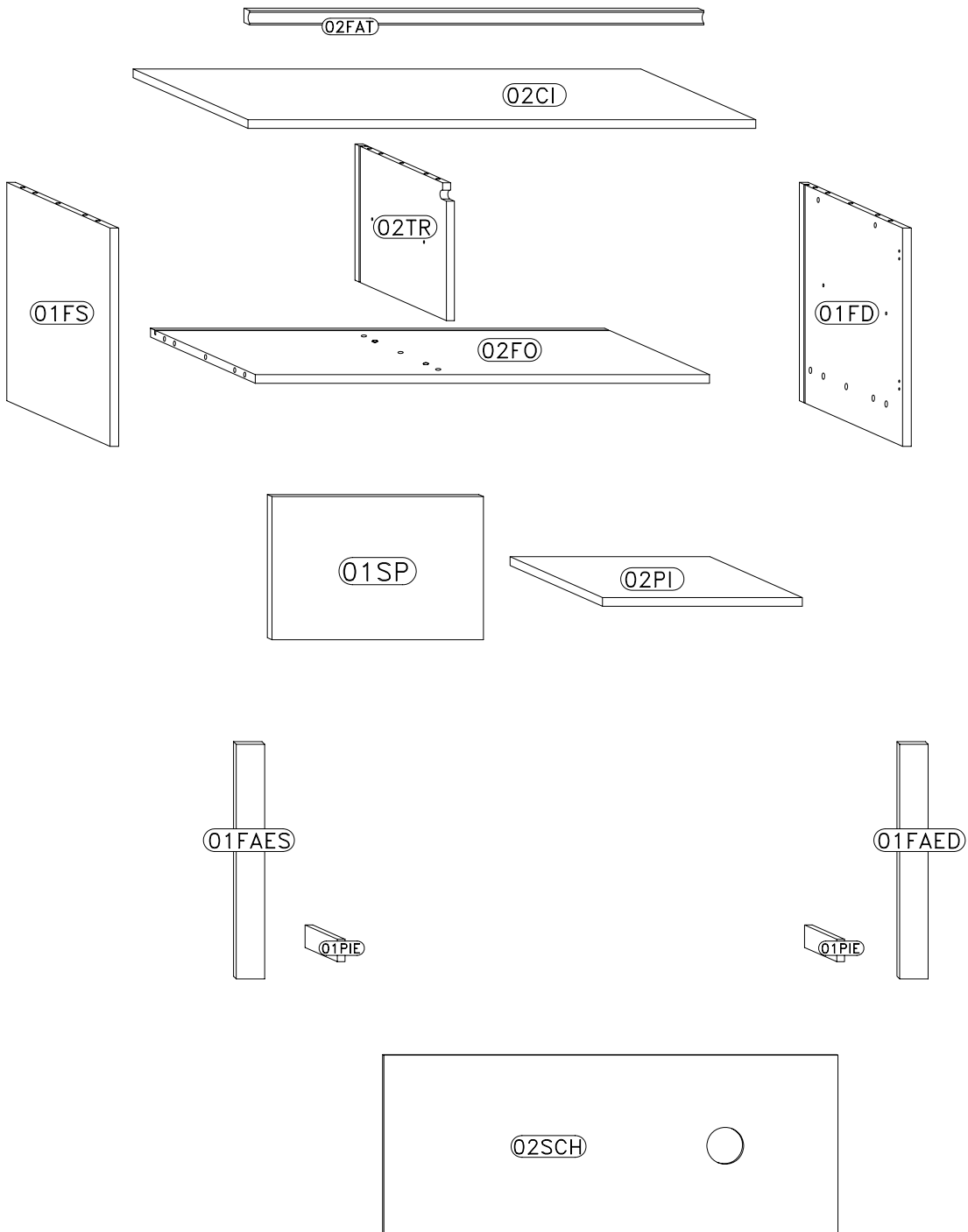
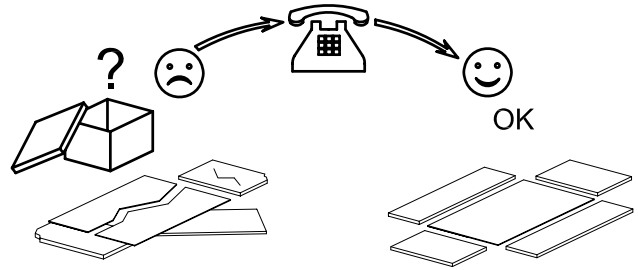
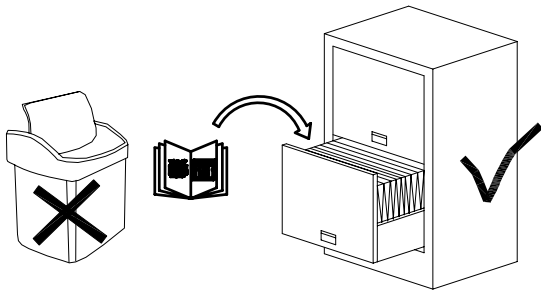





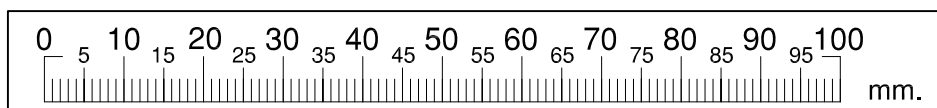
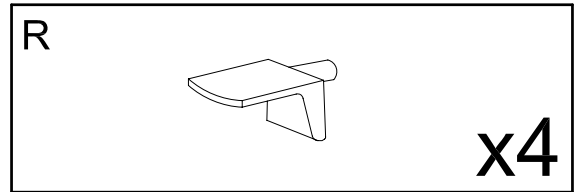
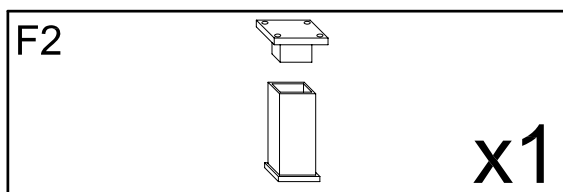
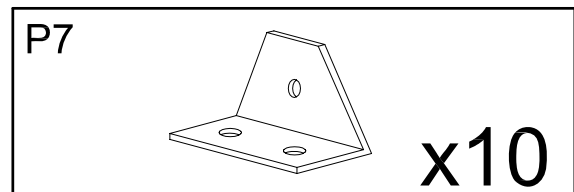
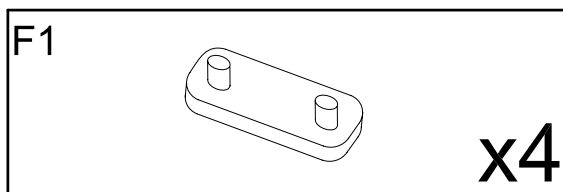
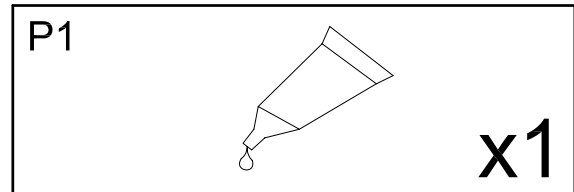
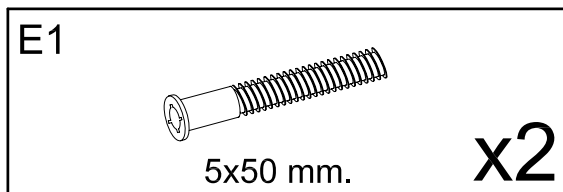
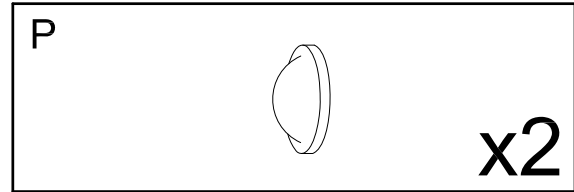
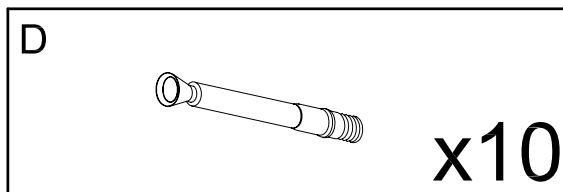
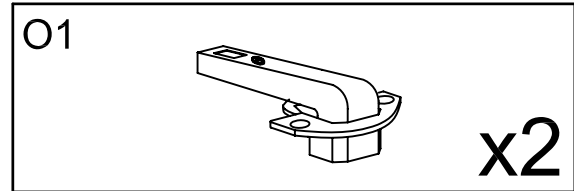
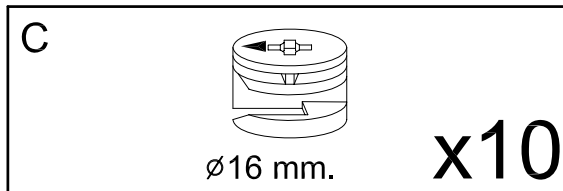
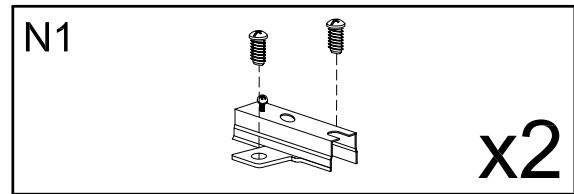
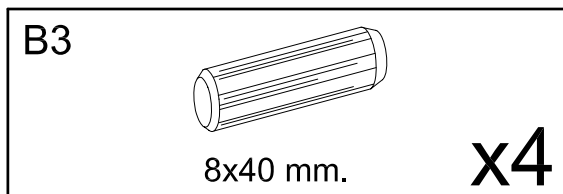
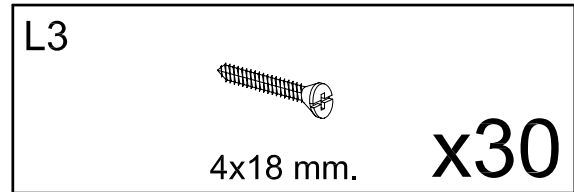
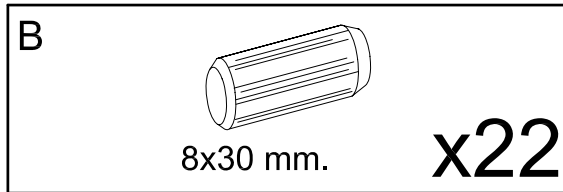
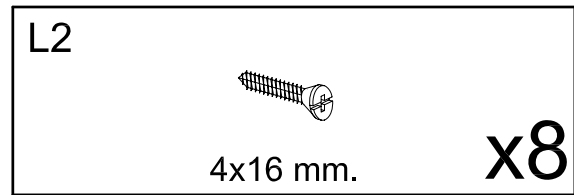
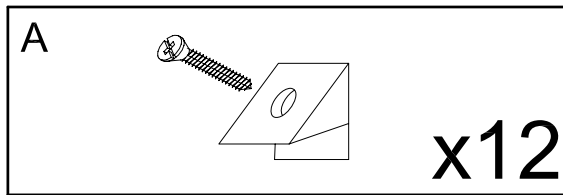

ONDERDELEN LYST-SERVICEKARTE-FORMULAIRE DEMANDES SAV-SPAREPARTS LIST-SCHEDA DI SERVIZIO

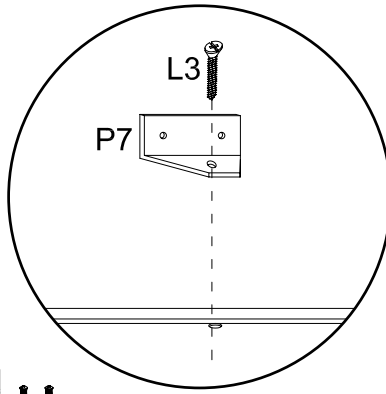
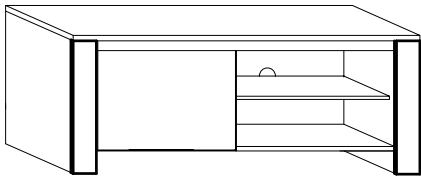
BESLAG-BESCHLAEGE - QUINCALLERIE - HARDWARE - FERRAMENTA



1



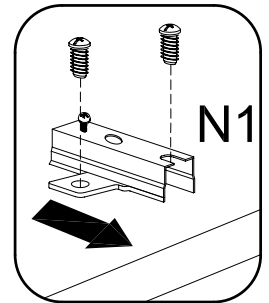
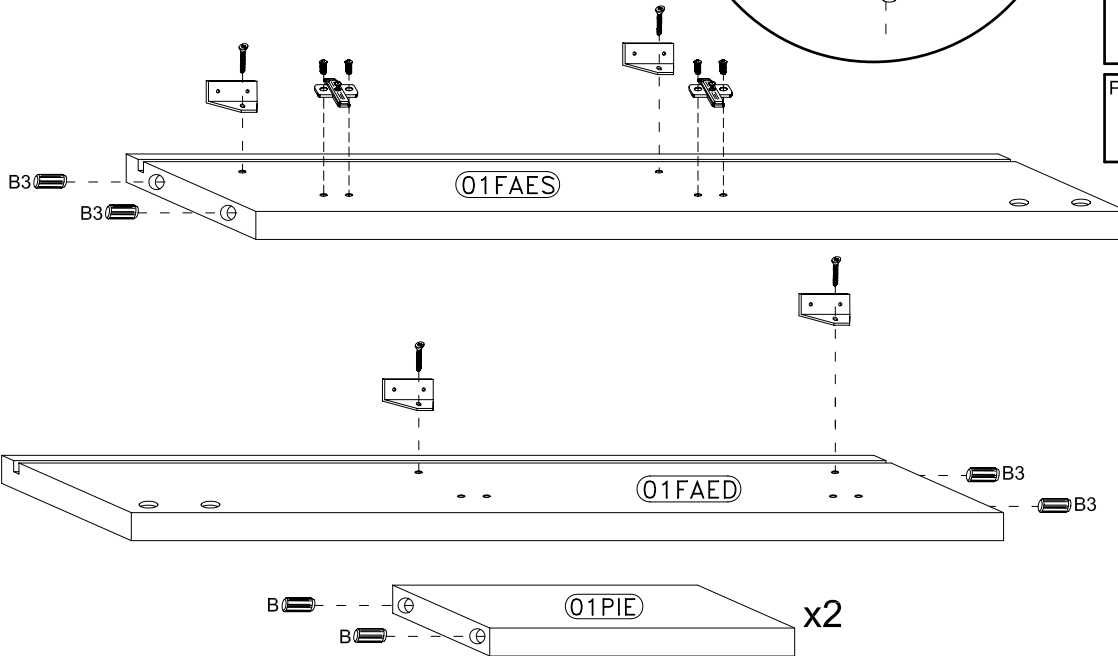

- B  8x30 mm. x4
- B3  8x40 mm. x4
- L3  4x18 mm. x4
- N1  x2
- P7  x4

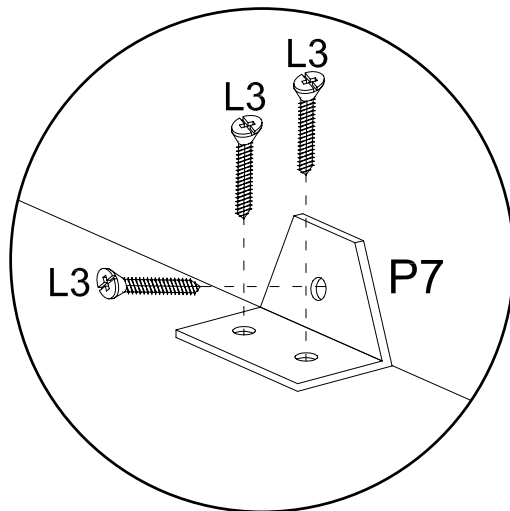
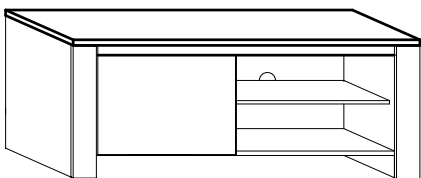

2



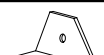

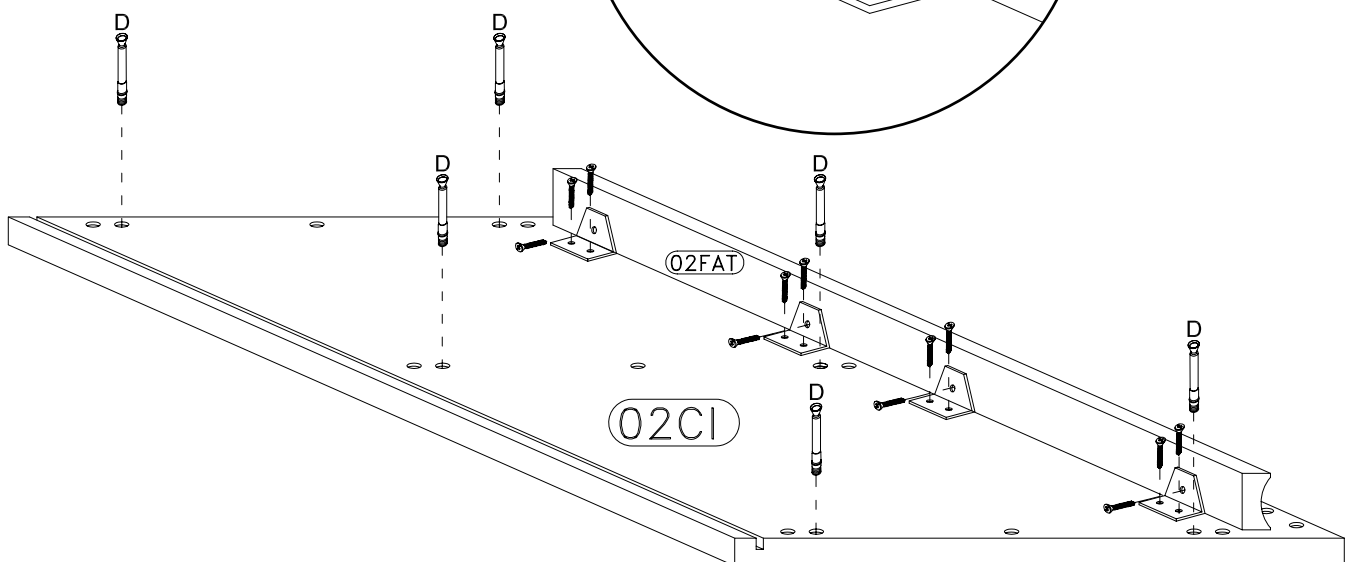
- D  x6
- L3  4x18 mm. x12
- P7  x4

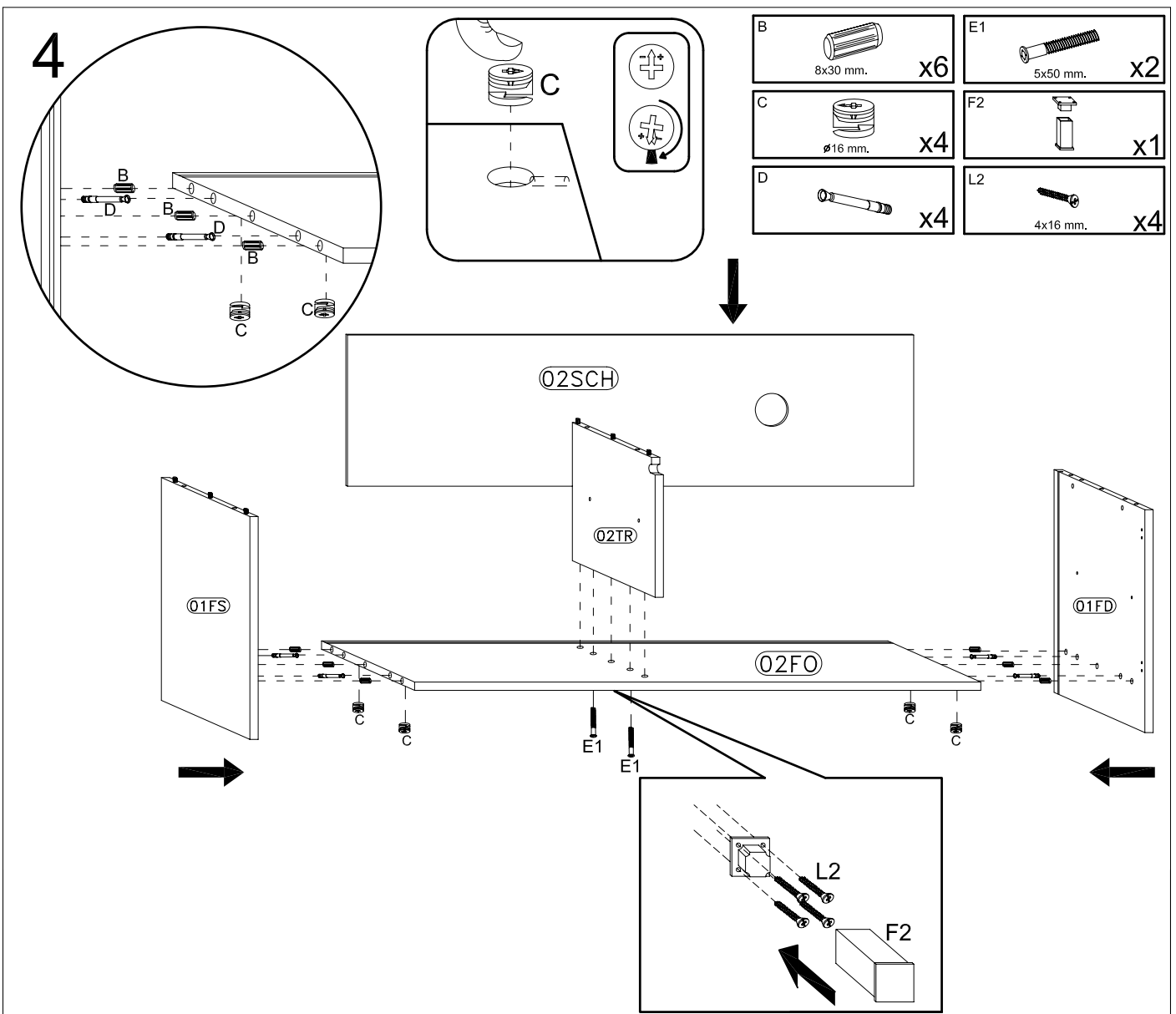
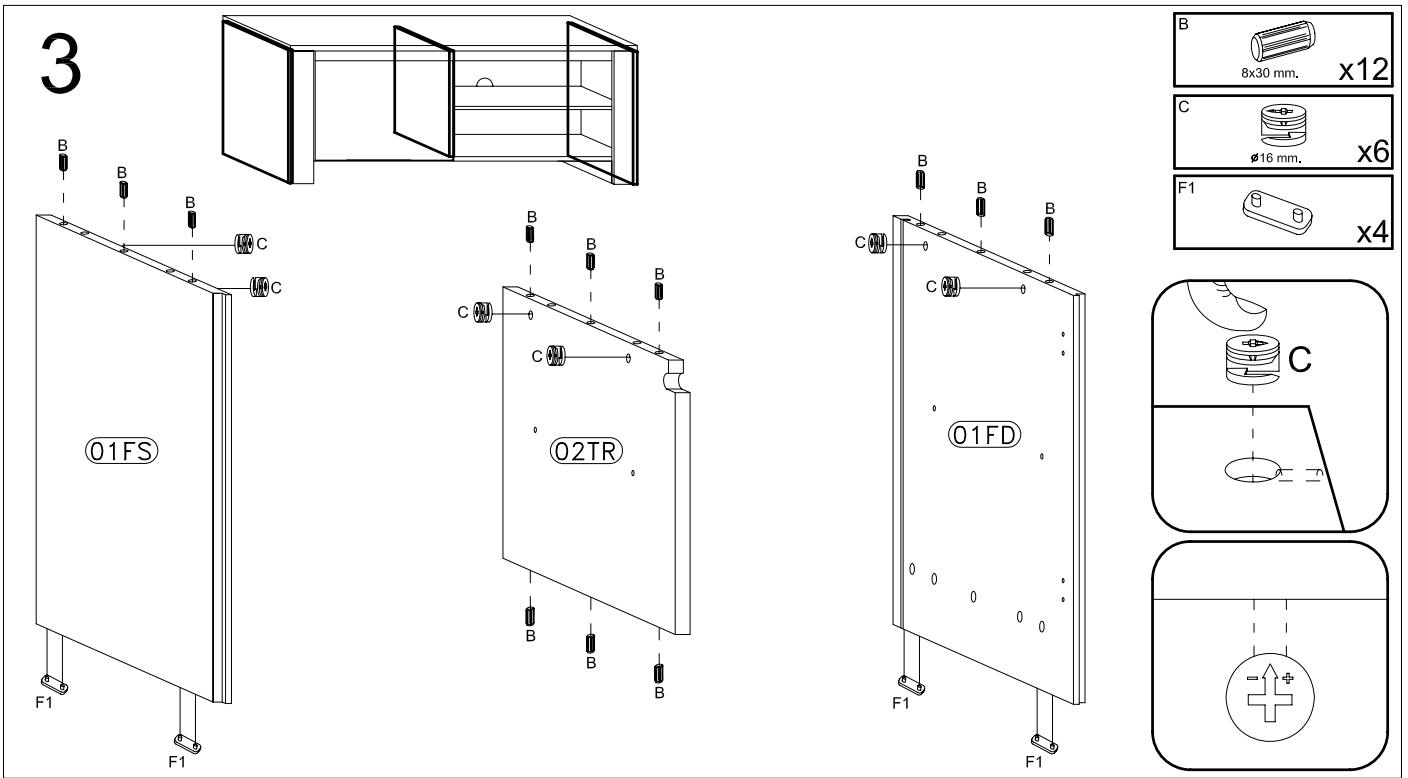

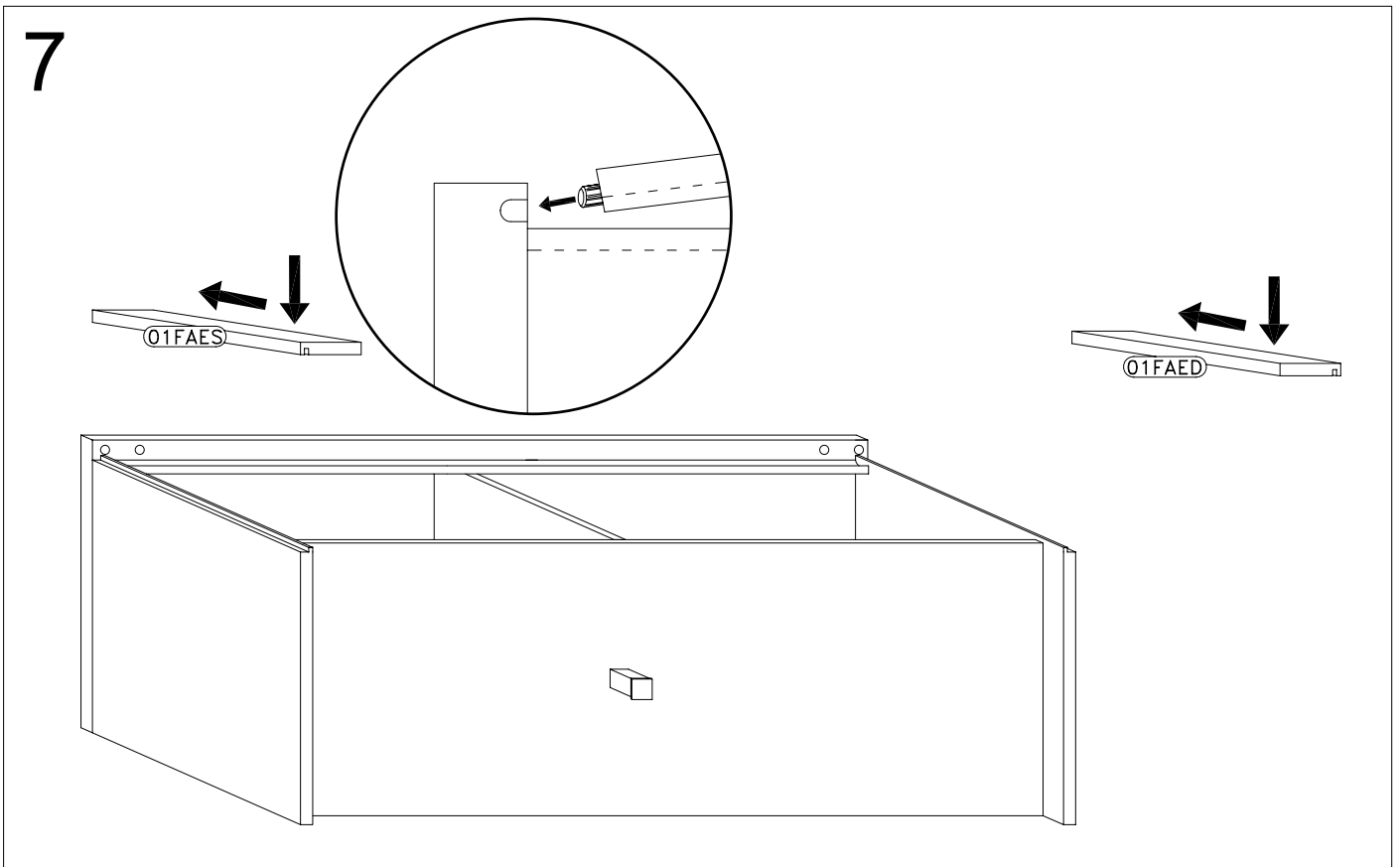
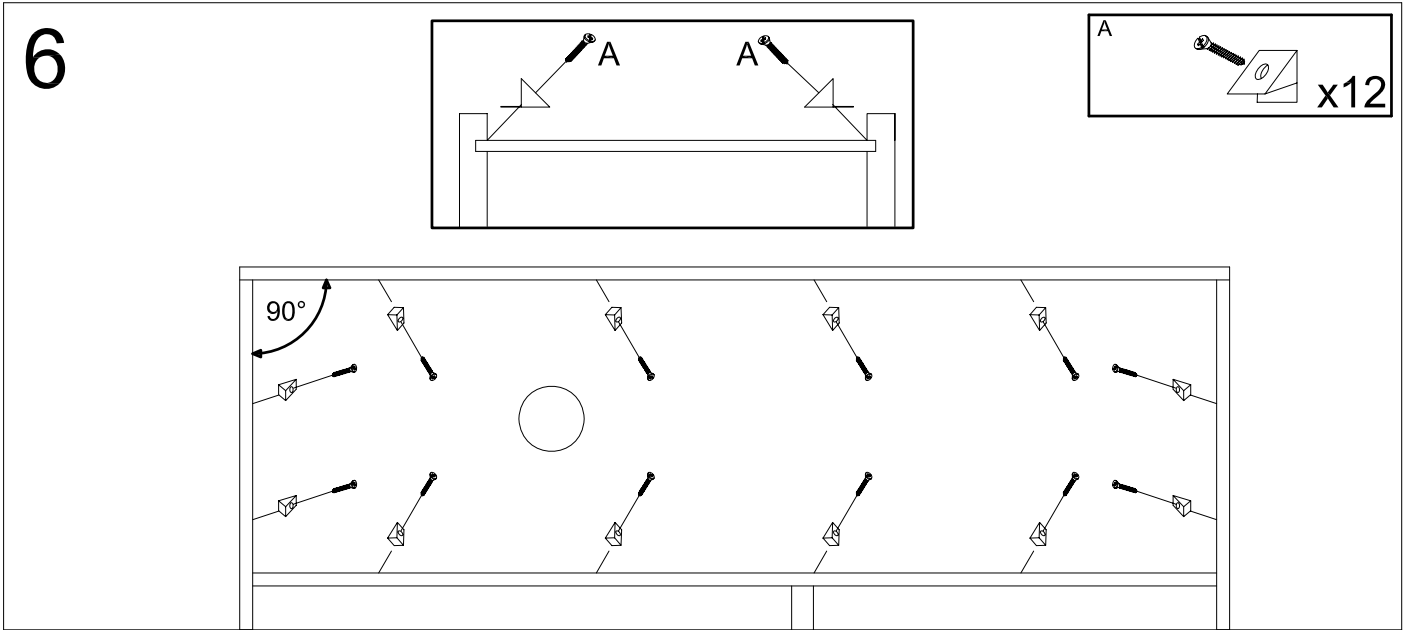
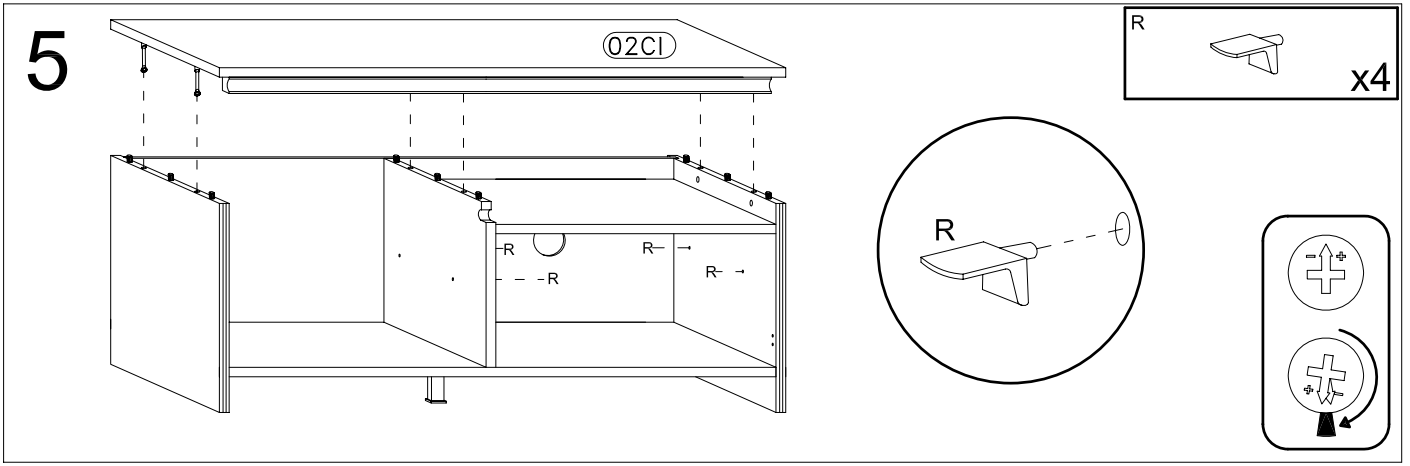



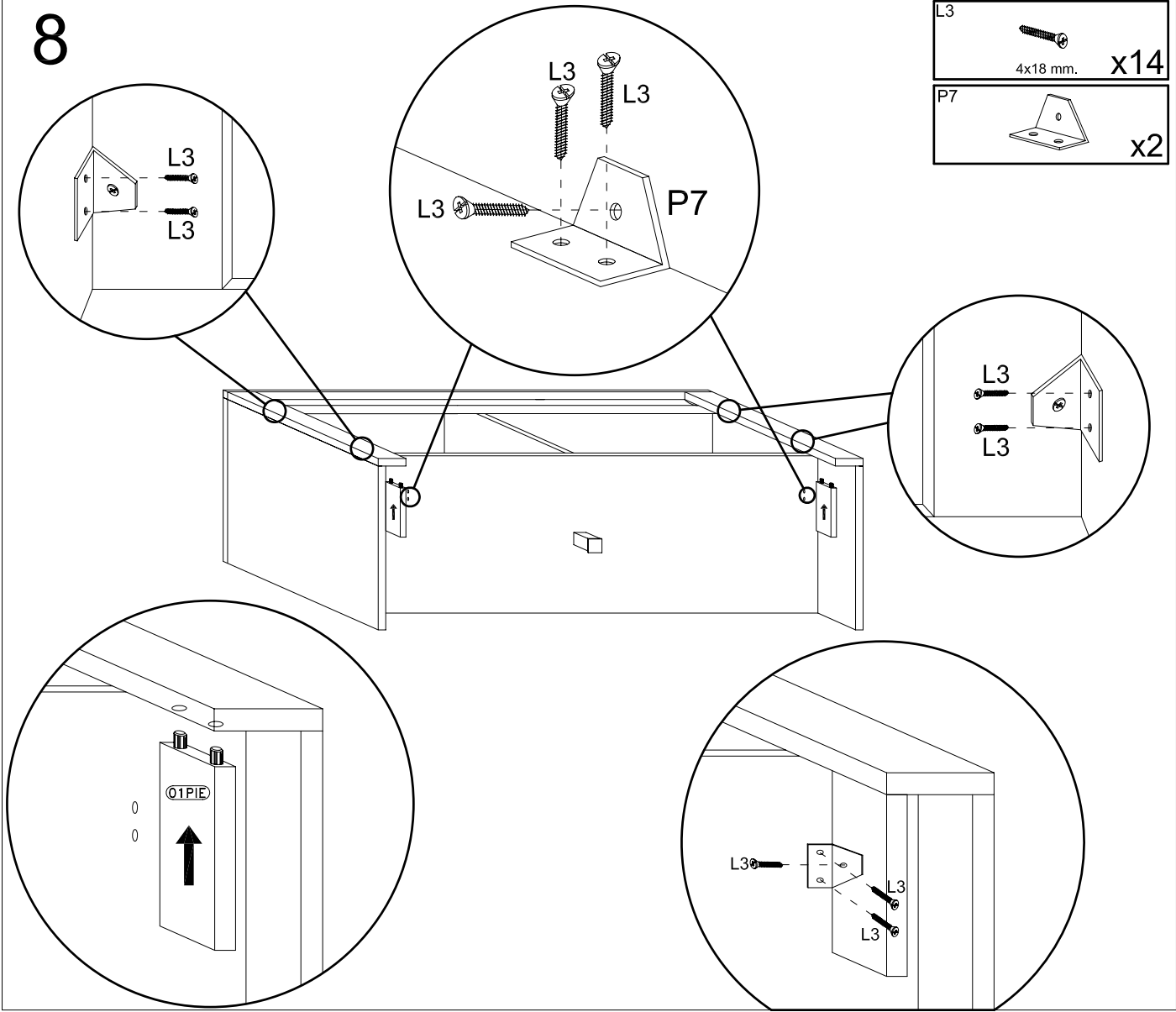

8

L3		x14
4x18 mm.		
P7		x2

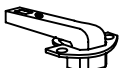

9

L2		x4
4x16 mm.		
O1		x2

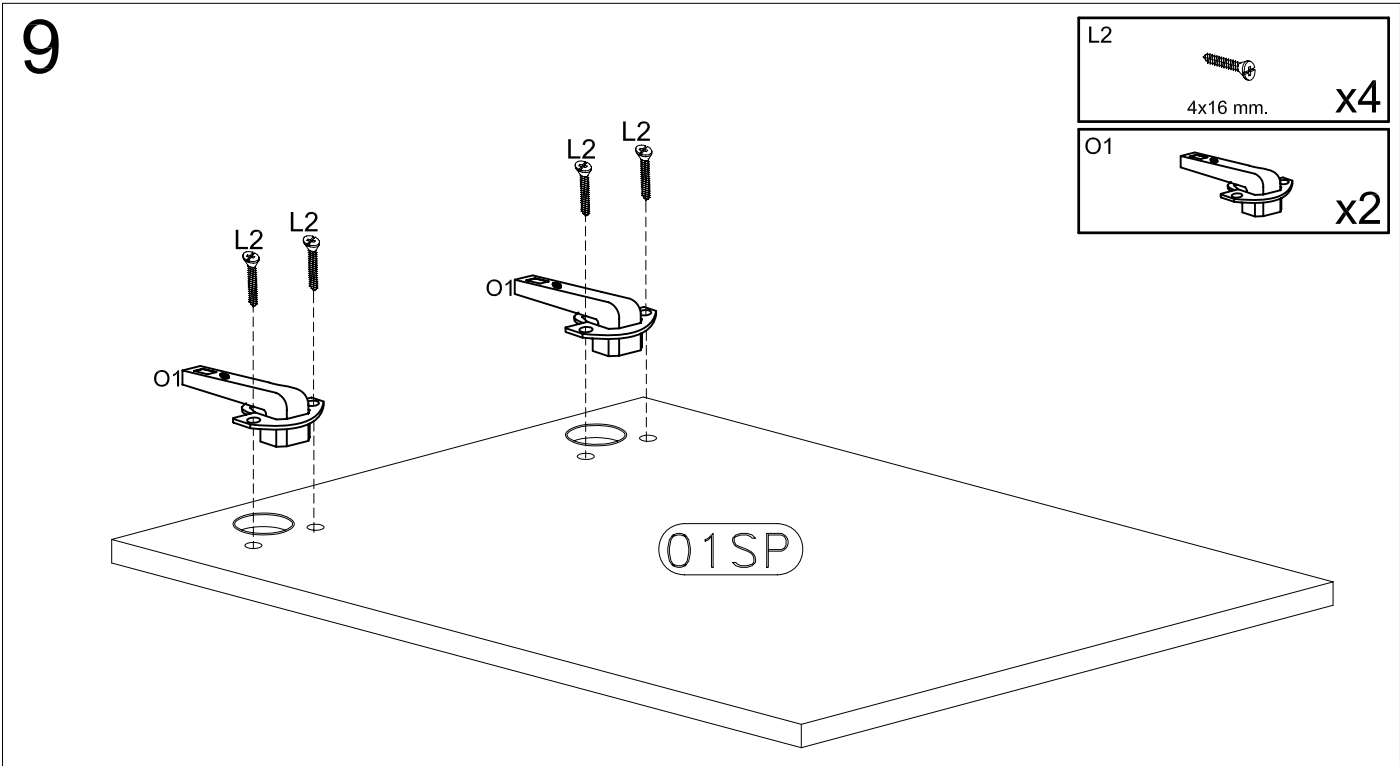

10

