

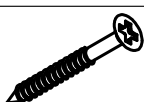







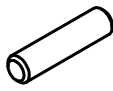
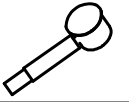

16	202	4x13	-		60
17	203	4x35	-		8
18	301	1.6x25	-		110
19	602	4x13	-		8
20	410	Ø8x30	-		52
21	561	-	-		24
22	406	Ø7x50	-		6
22.01	-	-	-		2
23	405	5.4-X-01	-		8
24	404	Nakl 110	-		4
25	451	L=400	-		4
26	-	-	-		2
27	-	-	-		4
28	470	H008 D14	-		6

# СБ-2254 "БЕСТА" SB-2254 "WESTA"

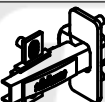

## Внимание!

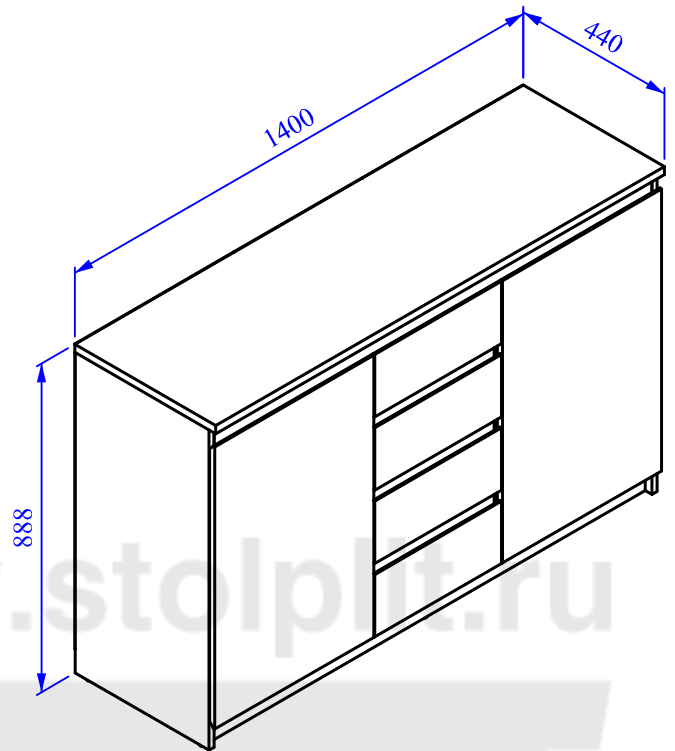
- Для разборки шариковых направляющих поз. 26 надавите на рычаг блокировочного устройства на планке поз. 26B
- Снимите внутренние подвижные планки поз. 26B шариковых направляющих.

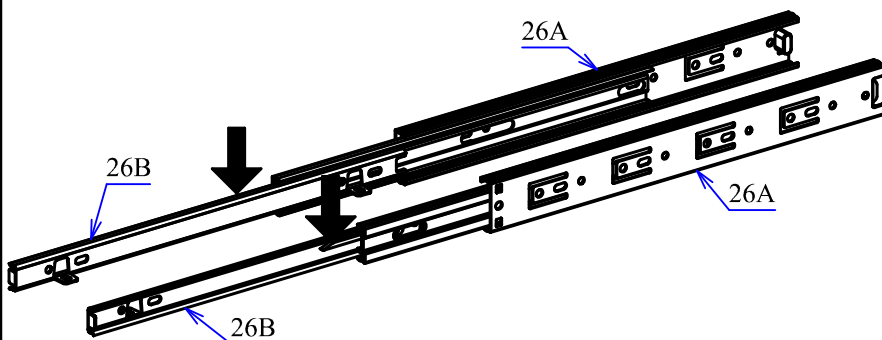

Поз.	L	B	S	Кол.
01	1400	440	22	1
02	866	418	16	1
03	866	418	16	1
04	730	418	16	1
05	730	418	16	1
06	1366	418	16	1
07	1366	60	16	2
08	418	60	16	1
09	762	496	16	2
10	475	398	16	2
11	1366	60	16	1
12.01	396	168	16	4
12.02	400	115	16	4
12.03	400	115	16	4
12.04	327	94	16	4
12.05	336	404	3	4
13	384	60	16	3
14	824	497	3	2
15	824	400	3	1

# СБ-2254 "ВЕСТА" SB-2254 "WESTA"

