

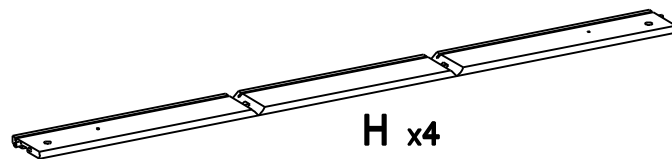

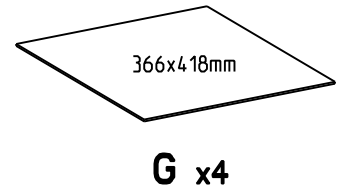

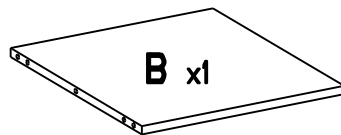

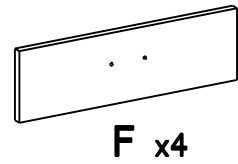

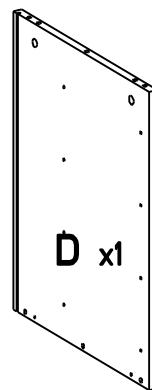
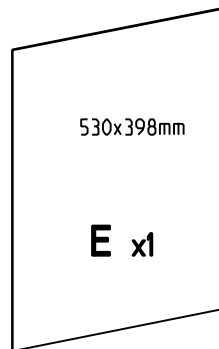
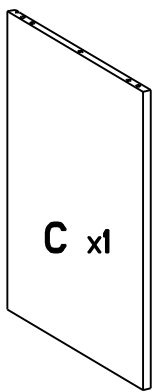
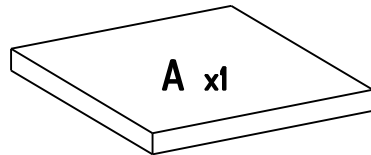

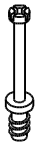
NR. 756

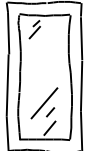
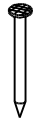
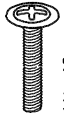

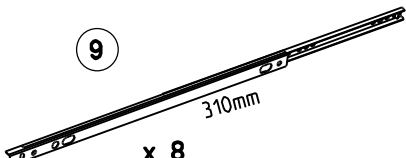
- 1  x 12
- 2  x 16
- 3  x 8
- 4  x 8
- 5  x 1
- 6  x 25
- 7  M4x18 x 8
- 8  x 4

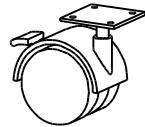
- 9  310mm x 8
- 10  $\phi 5.8 \times 11$ x 16
- 11  M4x9 x 8
- 12  x 4
- 13  $\phi 4 \times 16$ x 16
- 14  x 6

1

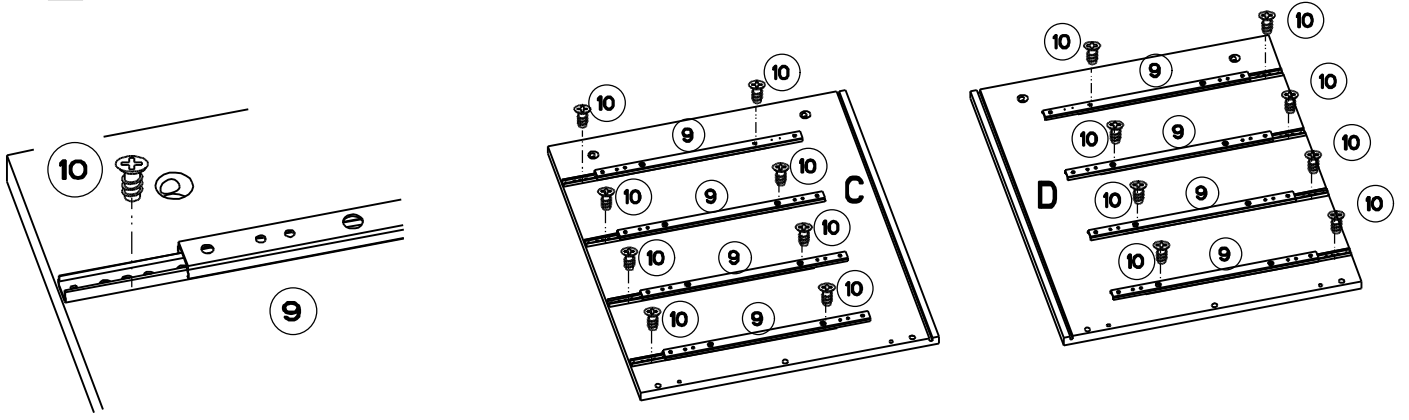

2

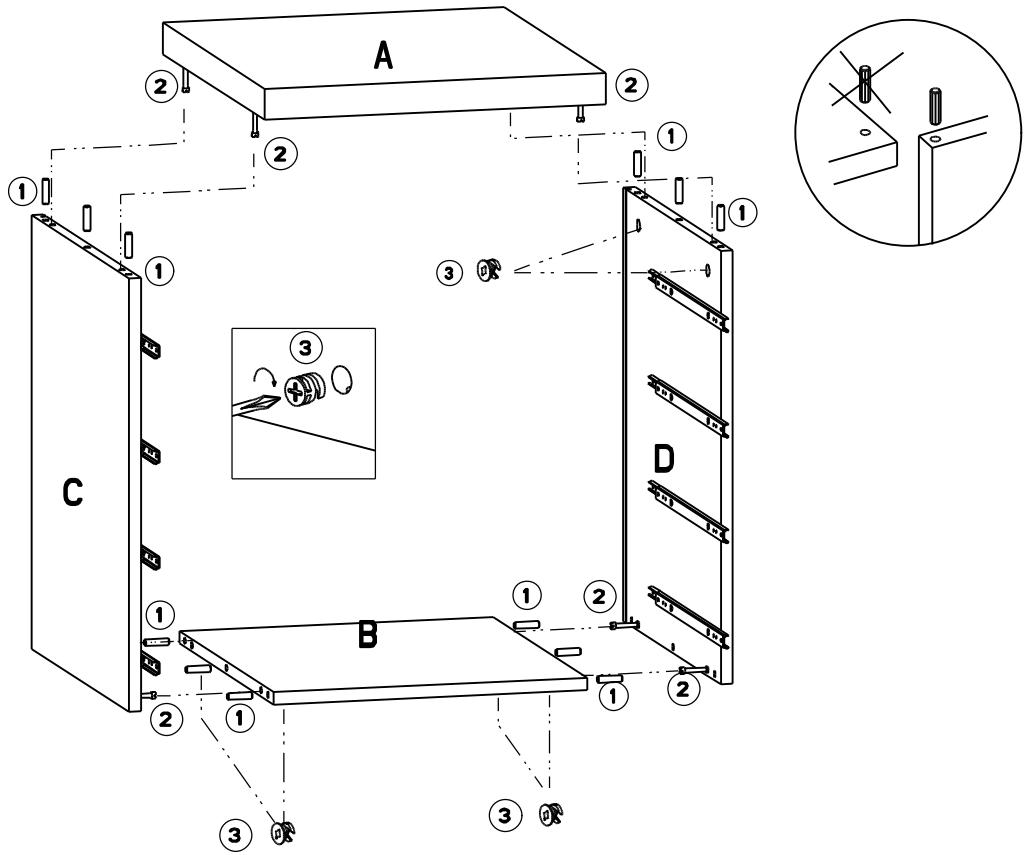

3

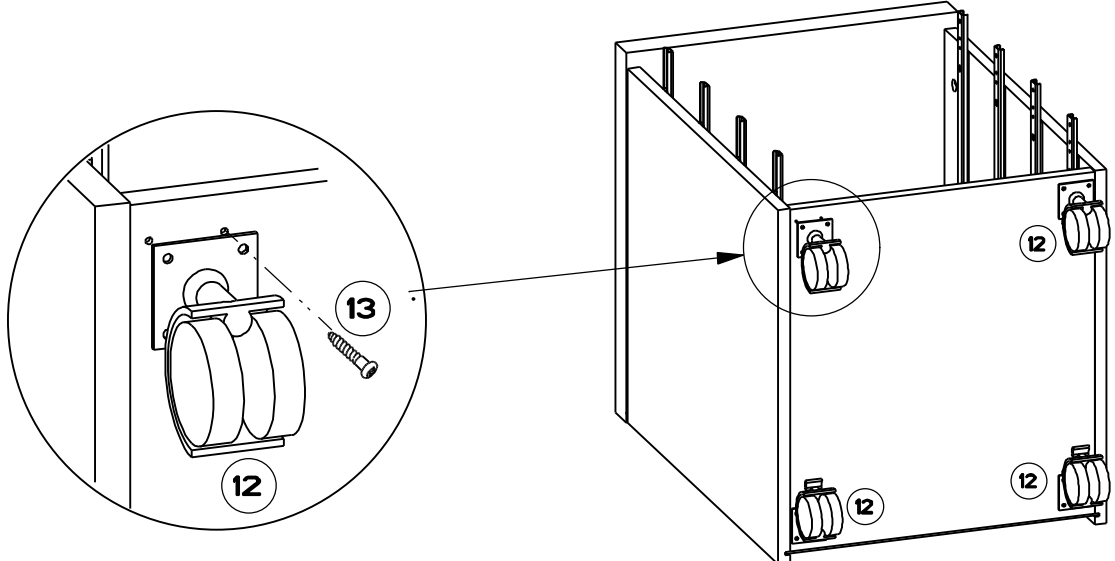

4

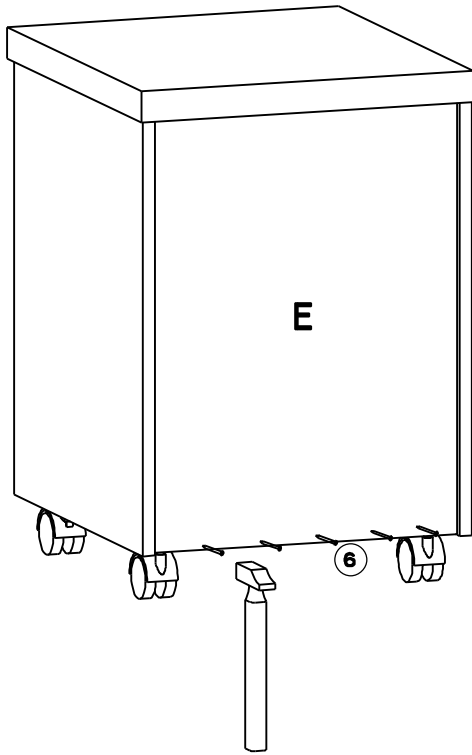

5

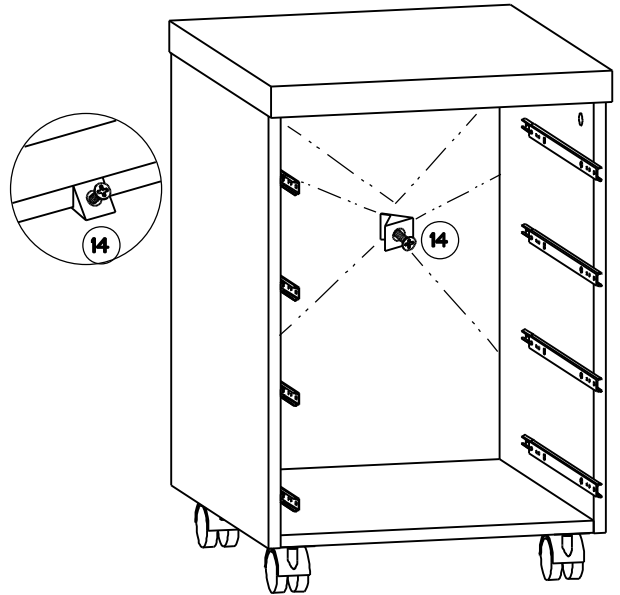

6

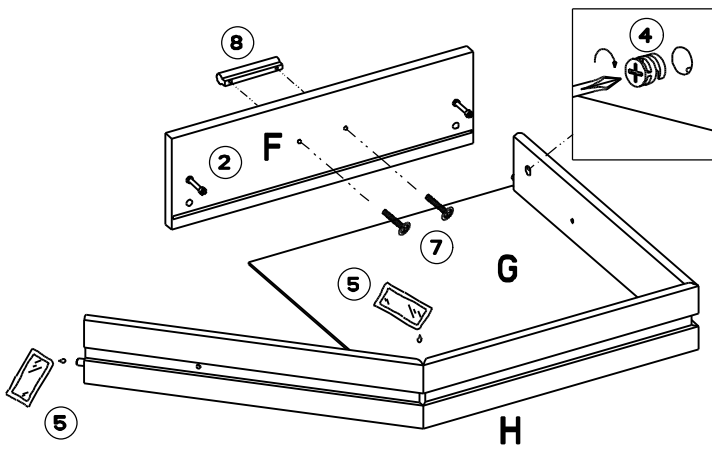

7

