

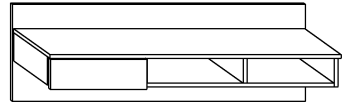

UNO - BIURKO

► 121 ↑ 40 ▼ 40



x 18



(a)

x 6



(b)

x 12



(c)

x 12



(d)

x 1 kpl. (350 mm)

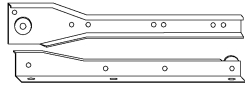

(e)

x 2



(f)

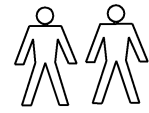

30 min

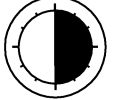

x 4

(3,5x30)



(g)

x 12

(3,5x16)



(h)

x 10



(i)

x 1



(j)



1 - FAZY MONTAŻU

A - OZNACZENIE ELEMENTÓW

a - OZNACZENIE AKCESORIÓW

1

x 2



(b)

x 4



(c)

x 1 kpl.



(e)

x 8

(3,5x16)



(i)

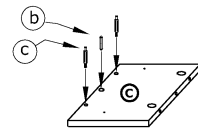
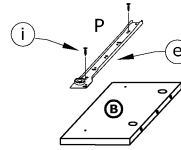
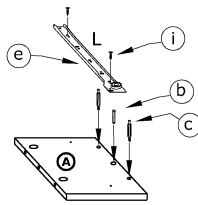

2

x 4



(b)

x 8



(c)

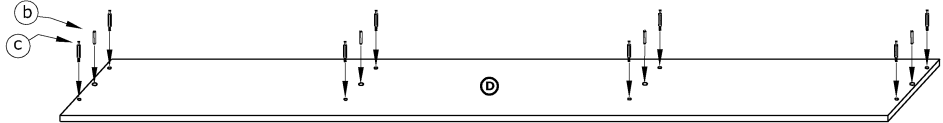

3

x 4

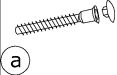

(a)

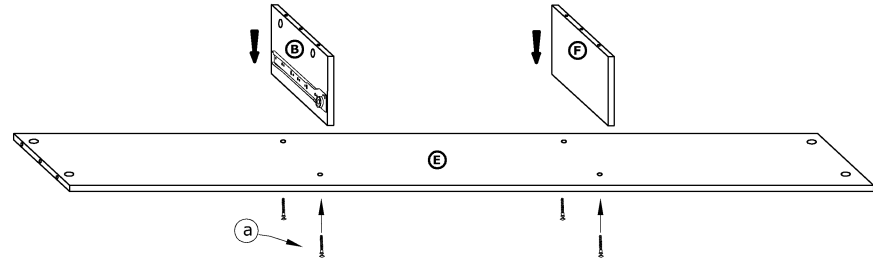

4

x 4

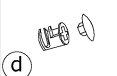

(d)



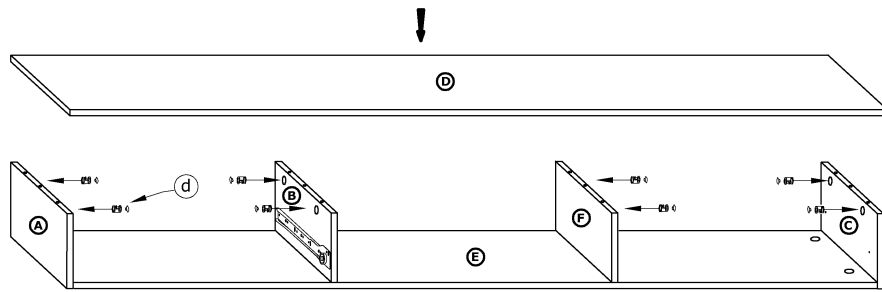

5 x 8

 d

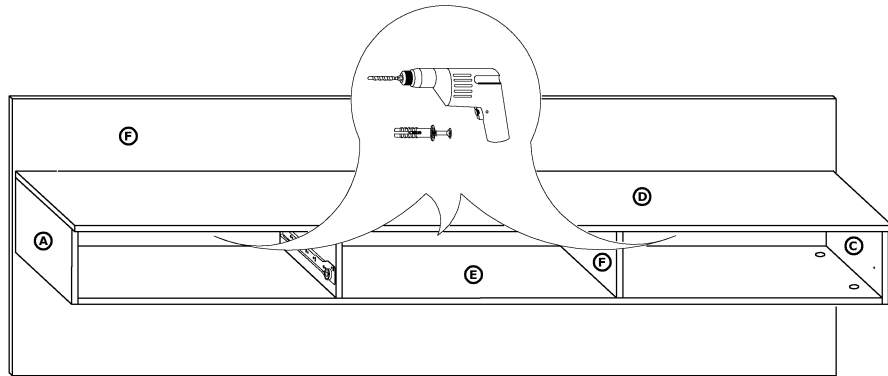
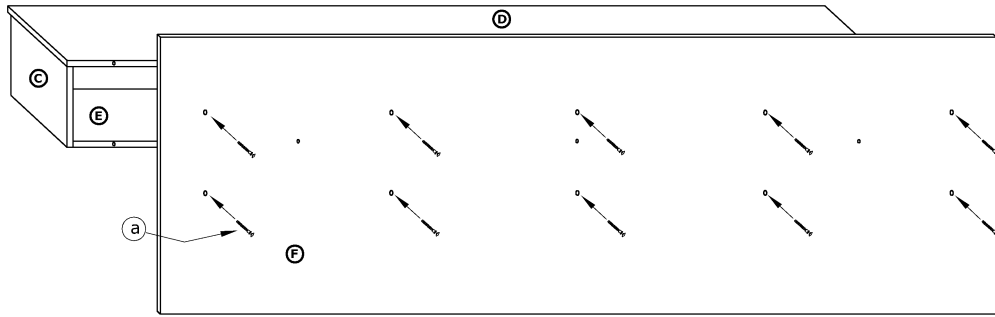



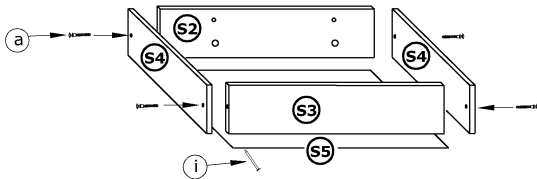

6 x 10

 a

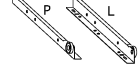

7 x 4 x 10
 
 a i

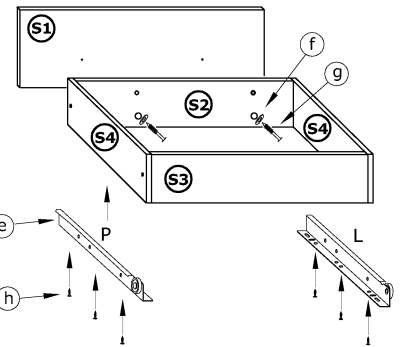

8 x 1 kpl. x 2
 
 e f
 x 2 x 6
 (3,5x30) (3,5x16)
 
 g h



9 x 2
 (3,5x30)

 g

