

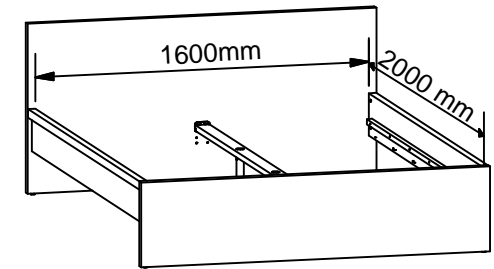















A	B	C (mm)		D
1	L26-103	2000	200	1/2
2	L26-104	2000	200	1/2
3	L26-409	1674	800	2/2
4	L26-410	1674	400	2/2
5	ZZ1-745	1983	70	1/2
6	ZZ1-747	1880	25	1/2



- 16x  **e2**  
Ø6.3x13 mm
- 8x  **e3**  
Ø6x13 mm
- 12x  **f1**  
Ø8x30 mm
- 4x  **j117**  
M6x84 mm
- 6x  **k1**
- 2x  **k242**
- 2x  **k243**
- 2x  **n341**
- 2x  **n342**
- 2x  **n63**  
130x34x34/2 mm
- 6x  **p6**  
Ø4x35 mm
- 12x  **p10**  
Ø4x40 mm
- 6x  **p16**  
Ø3.5x25 mm
- 4x  **r51**  
Ø10x13 mm
- 1x  **z1**

**A**

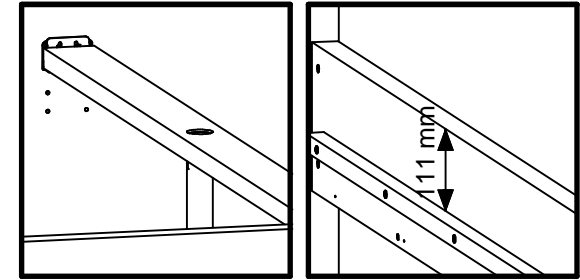
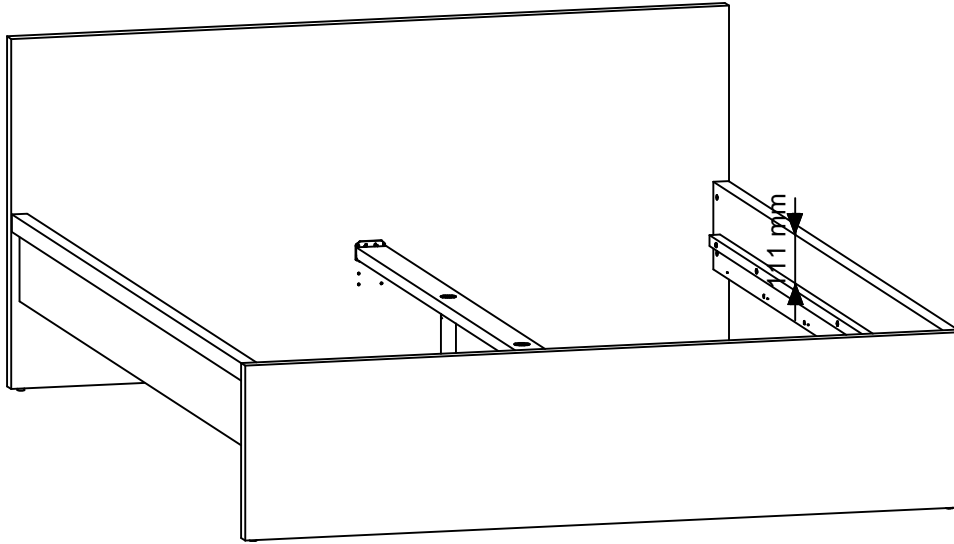

**B**

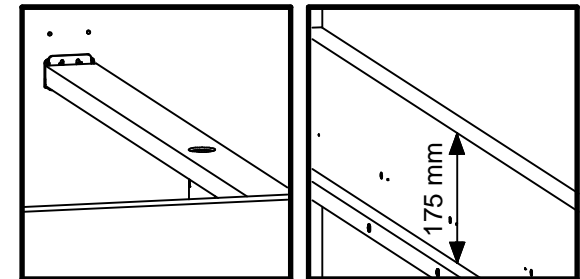
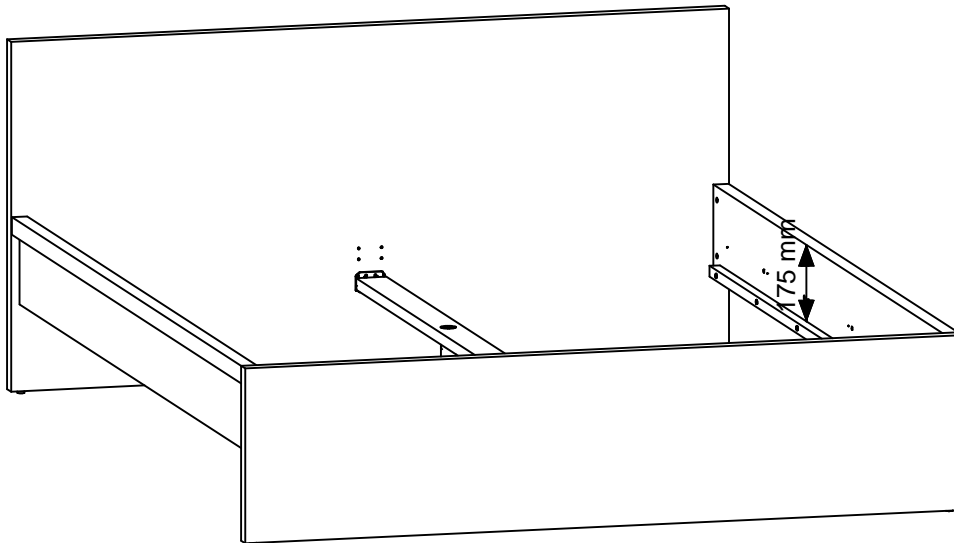

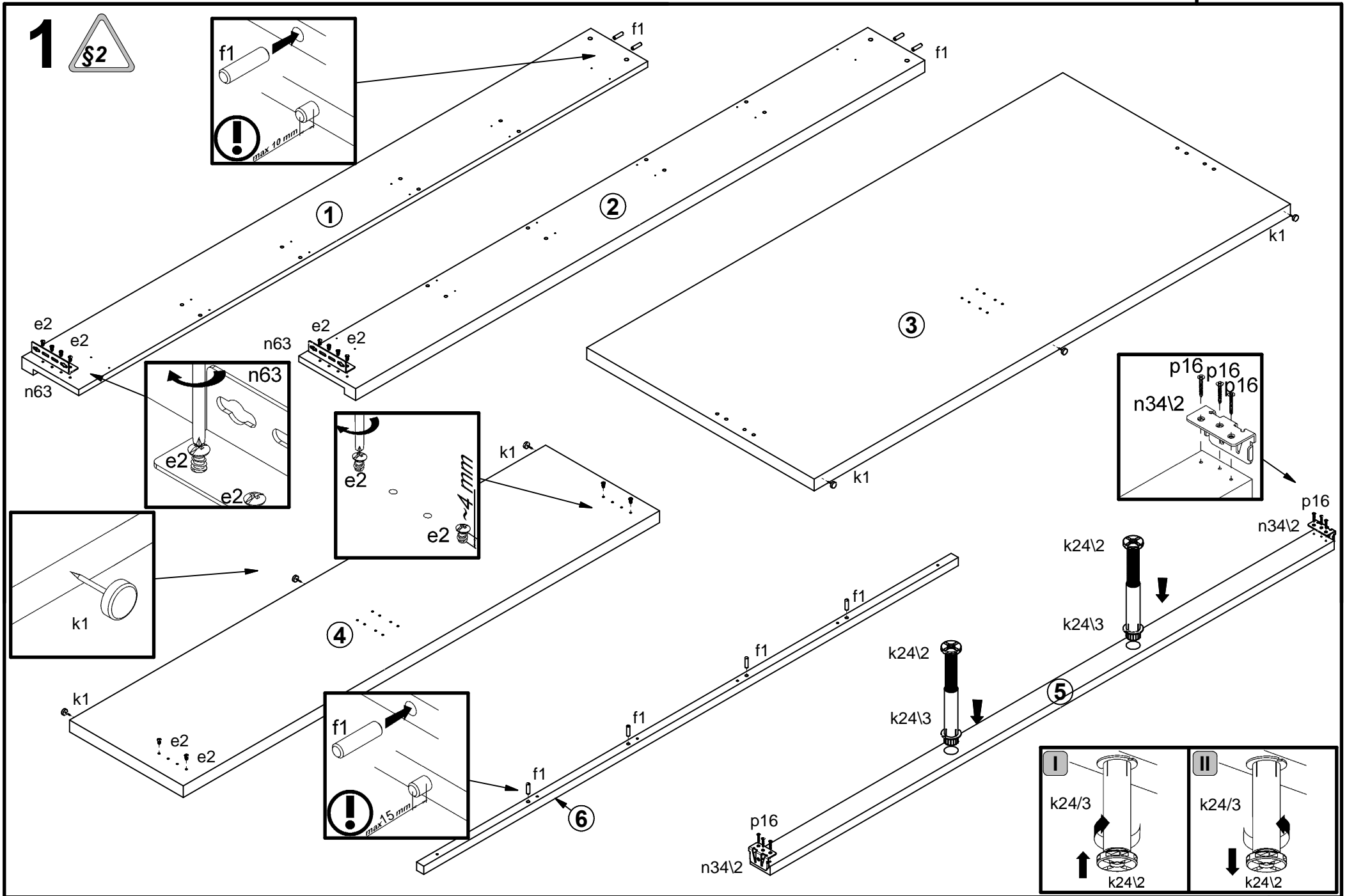

# 3A

§14

# 2

§6

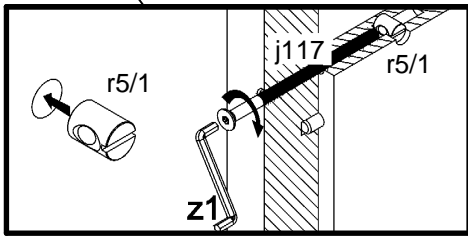
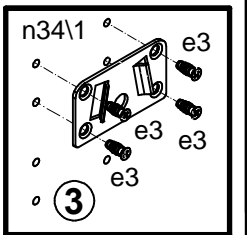
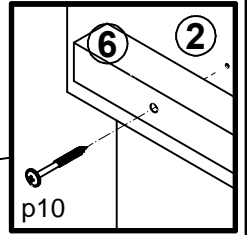
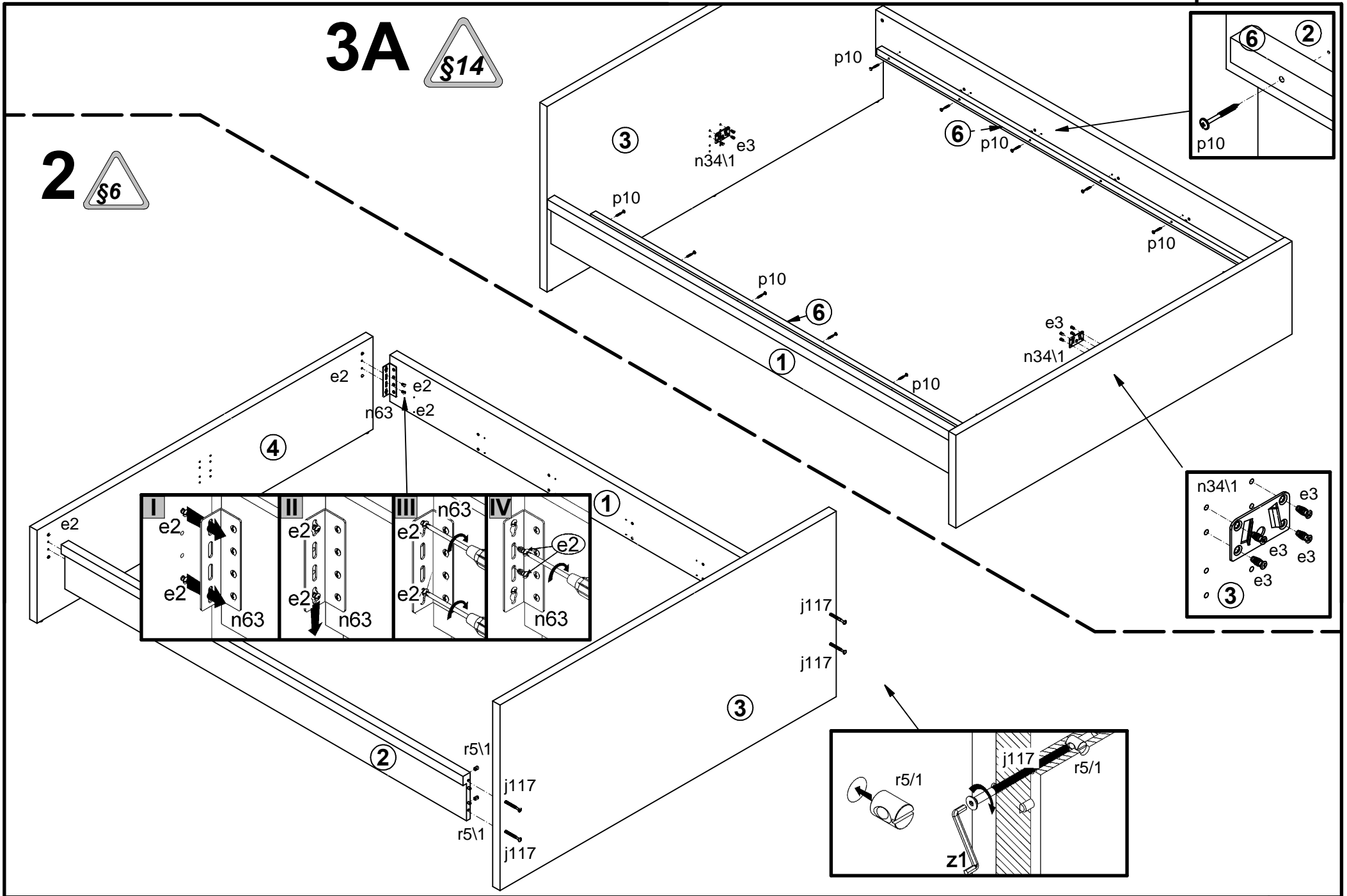

4

3B

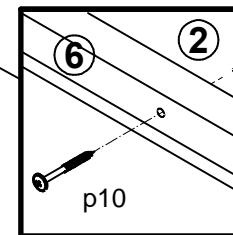
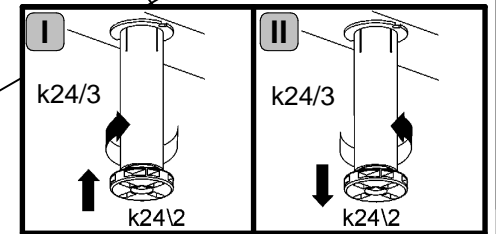
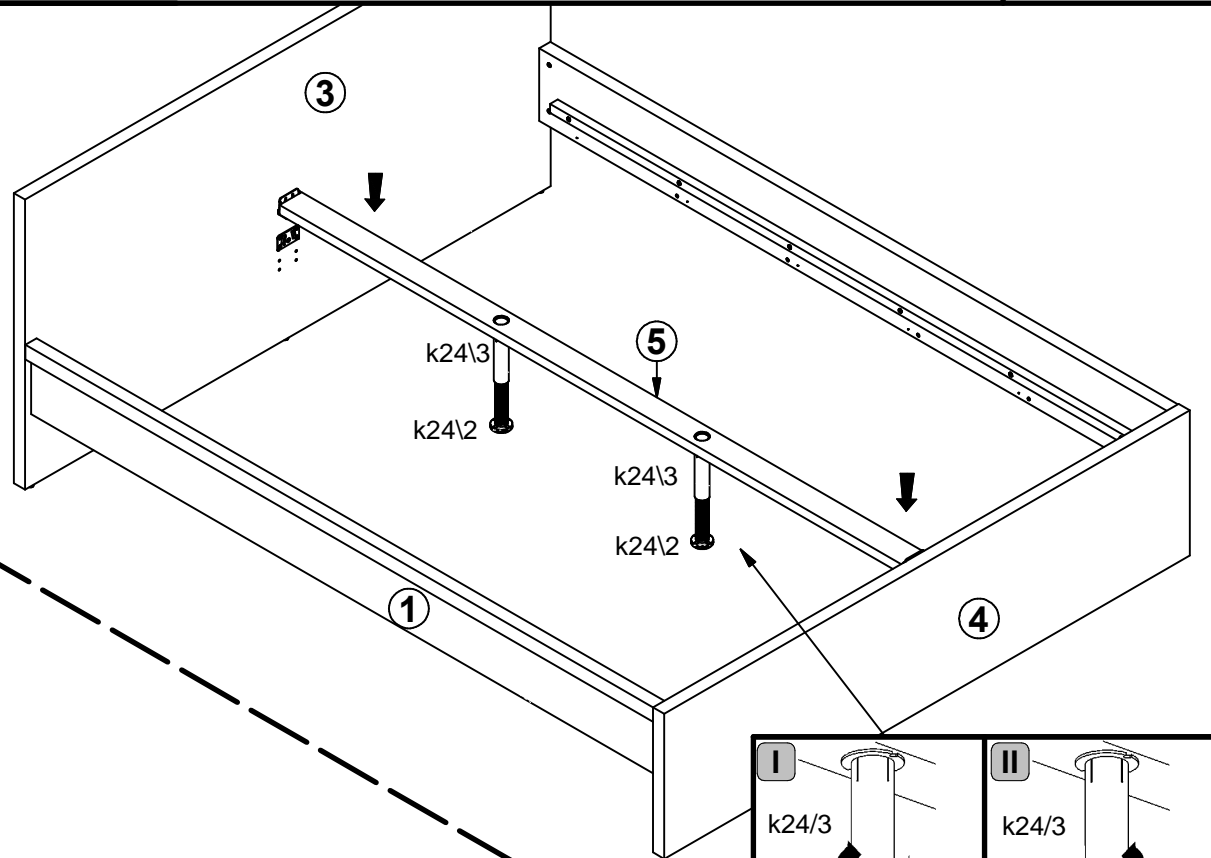
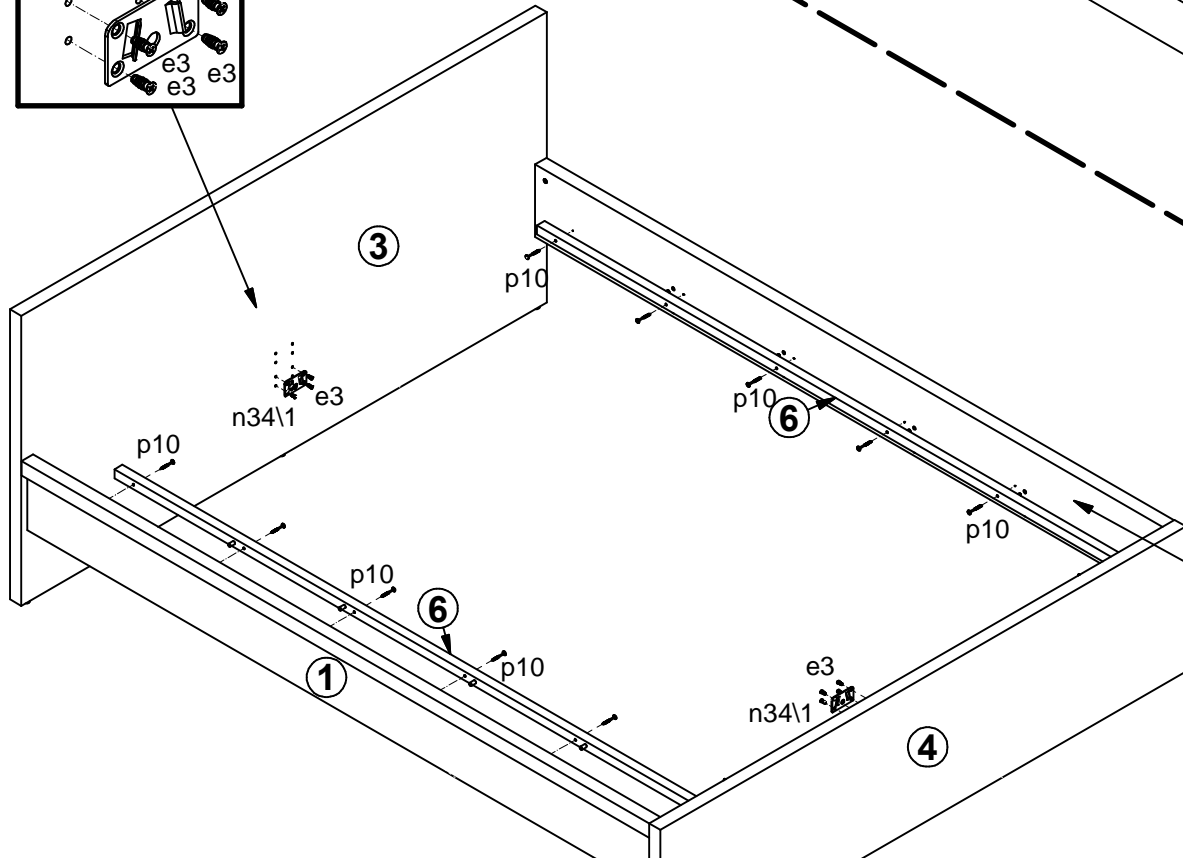
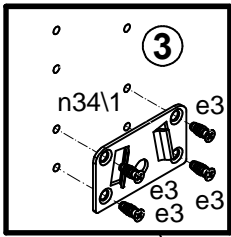

5

