

MEUBLES  
DEMEYERE

SAV  
SPAREPARTS  
KUNDERDIENST  
POST VENTAS  
SERVICE NA VERKOOP  
SERVIZIO POST-VENDITA  
SERVICO DEPOIS DE VENDA  
SERWIS POGWARANCYJNY

70098

402179-0

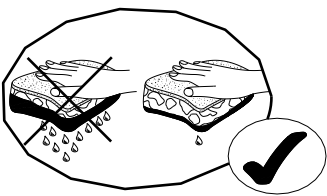
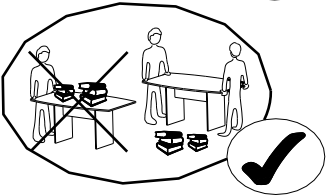
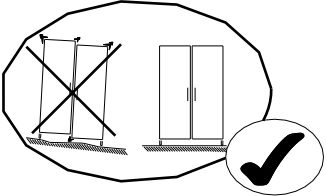
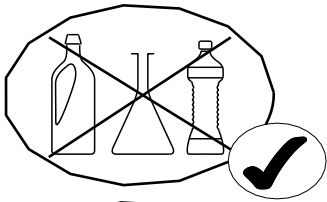

Rep	Dim	Qté
1	676x598	1
2	600x155	1
3	674x596	1

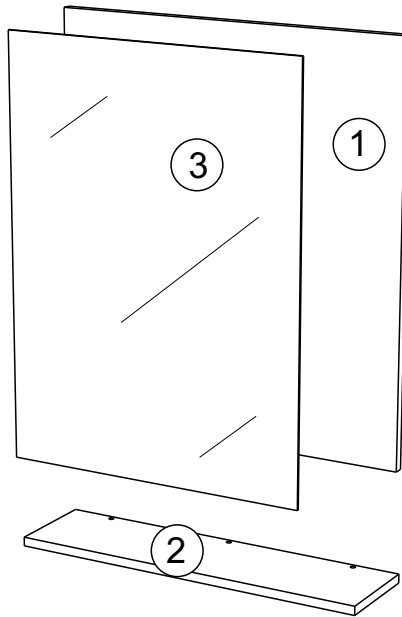
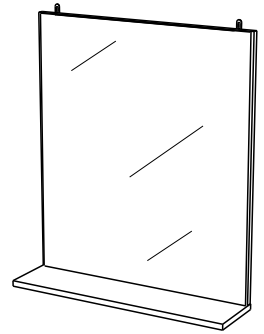

0H 30 Mn



**(FR) SECURITE**  
IMPORTANT-A LIRE SOIGNEUSEMENT-A CONSERVER  
POUR CONSULTATION ULTERIEURE

**(GB) CAUTION**  
IMPORTANT-TO BE READED CARREFULLY-TO BE  
CONSERVED FOR LATER CONSULTATION

**(DE) SICHERHEITSVORSCHRIFTEN**  
WICHTIG-GENAU DURCHZULESEN-AUFZUBEWAHREN  
FÜR SPÄTEREN GEBRAUCH

**(ES) SEGURIDAD**  
IMPORTANTE-LEER CON ATENCION-CONSERVAR  
PARA CONSULTAS POSTERIORES

**(NL) VEILIGHEID**  
BELANGRIJK-ZORGVULDIGGELEZEN TE WORDEN-BEWAARD  
TE WORDEN VOOR LATERE RAADPLEGING

**(IT) SICUREZZA**  
IMPORTANTE-DA LEGGERE ATTENTAMENTE-DA  
CONSERVARE PER CONSULTAZIONE ULTERIORE

**(PT) SEGURANCA**  
IMPORTANTE-PARA LER COM ATENCAO-PARA  
CONSERVAR PARA COOSULTA ULTERIOR

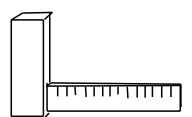
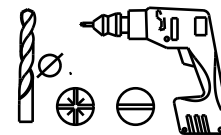
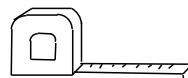
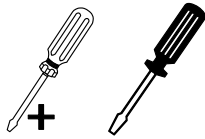

**(PL) UWAGA**  
WAZNE-UWAZNIE PRZECZYTAC-ZACHOWAC  
CELEM POZNIEJSZYCH KONSULTACJI

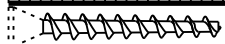
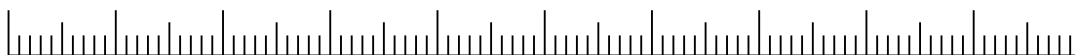

0 1 2 3 4 5 6 7 8 9 10

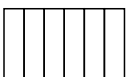
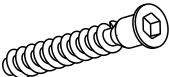
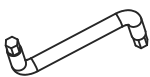

FABRICATION FRANCAISE

359408	X2	360915	X3	559	X2	340750	X3	434	X1
				 x6					

1	359408	X2
		

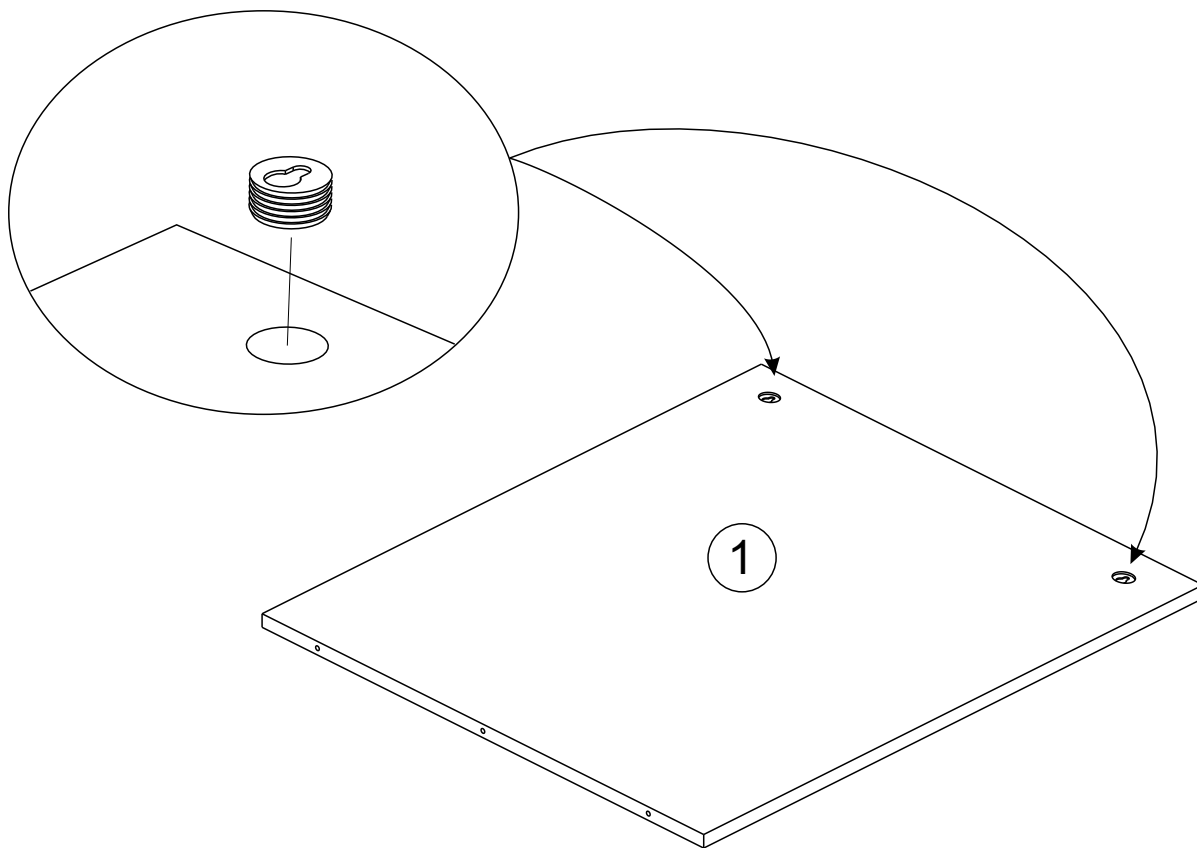

**(FR) MEUBLES A FIXER AU MUR:**  
 - FIXER LE MEUBLE AU MUR AVEC LES ATTACHES PREVUES A CET EFFET  
 - VERIFIER QUE LES VIS ET LES CHEVILLES UTILISEES SONT ADAPTEES AU SUPPORT

**(ES) MUEBLES A FIJAR EN LA PARED:**  
 - FIJAR EL MUEBLE EN LA PARED CON LAS GRAPAS PREVISTAS  
 - COMPROBAR QUE LOS TORNILLOS Y LAS CLAVIJAS UTILIZADAS SON ADAPTADAS AL SOPORTE

**(PT) MOVEIS A FIXAR NA PAREDE:**  
 - FIXAR O MOVEL NA PAREDE COM OS PRENDAS PREVISTOS  
 - VERIFICAR QUE OS PARAFUSOS E AS CAVILHAS UTILIZADOS SAO ADAPTADOS OA SUPORTE

**(EN) FURNITURES TO BE HOLD ON THE WALL:**  
 - HOLD THE FURNITURE ON THE WALL WITH THE FASTENINGS PROVIDED FOR THIS PURPOSE  
 - CHECK THAT THE SCREW AND PEGS FIT WITH THE SUPPORT

**(IT) MOBILI DA FISSARE AL MURO:**  
 - FISSARE IL MOBILE AL MURO CON LE FLANGIE PREVISTE A TALE SCOPO  
 - VERIFICARE CHE LE VITI ED I PERNI USATI SIANO ADATTI A QUEL TIPO DI SUPPORTO

**(PL) MEBEL PRZEZNACZONY DO ZAINSTALOWANIA NA ŚCIANIE:**  
 - NALEŻY ZAMONTOWAC TEN MEBEL NA ŚCIANIE PRZEZNACZONYMI DO TEGO CELU UCHWYTAMI  
 - NALEŻY SPRAWDZIC CZY SRUBY I KOSZULKI SA ODPOWIEDNIEJ WIELKOSCI W STOSUNKU DO UCHWYTÓW

**(DE) MOEBEL AN DER MAUER ZU BEFESTIGEN:**  
 - BEFESTIGEN SIE DAS MOEBELSTUECK MIT DEN DAFUER VORGESEHENEN BEFESTIGUNGSHAKEN  
 - UEBERPRUEFEN SIE BITTE DASS DIE SCHRAUBEN UND DUEBEL MIT DEM MATERIAL DER MAUER UEBEREINSTIMMEN

**(NL) MEUBELS DIE AAN DE MUUR GEFIXEERD MOETEN WORDEN:**  
 - FIXEER HET MEUBEL AAN DE MUUR MET DE DAARVOOR BESTEMDE HAKEN  
 - VERFIEER OF DE GEBRUIKTE SCHROEVEN BIJ DE BEVESTIGINGSHAAK HOREN

2

360915

X3

340750

X3

434

X1

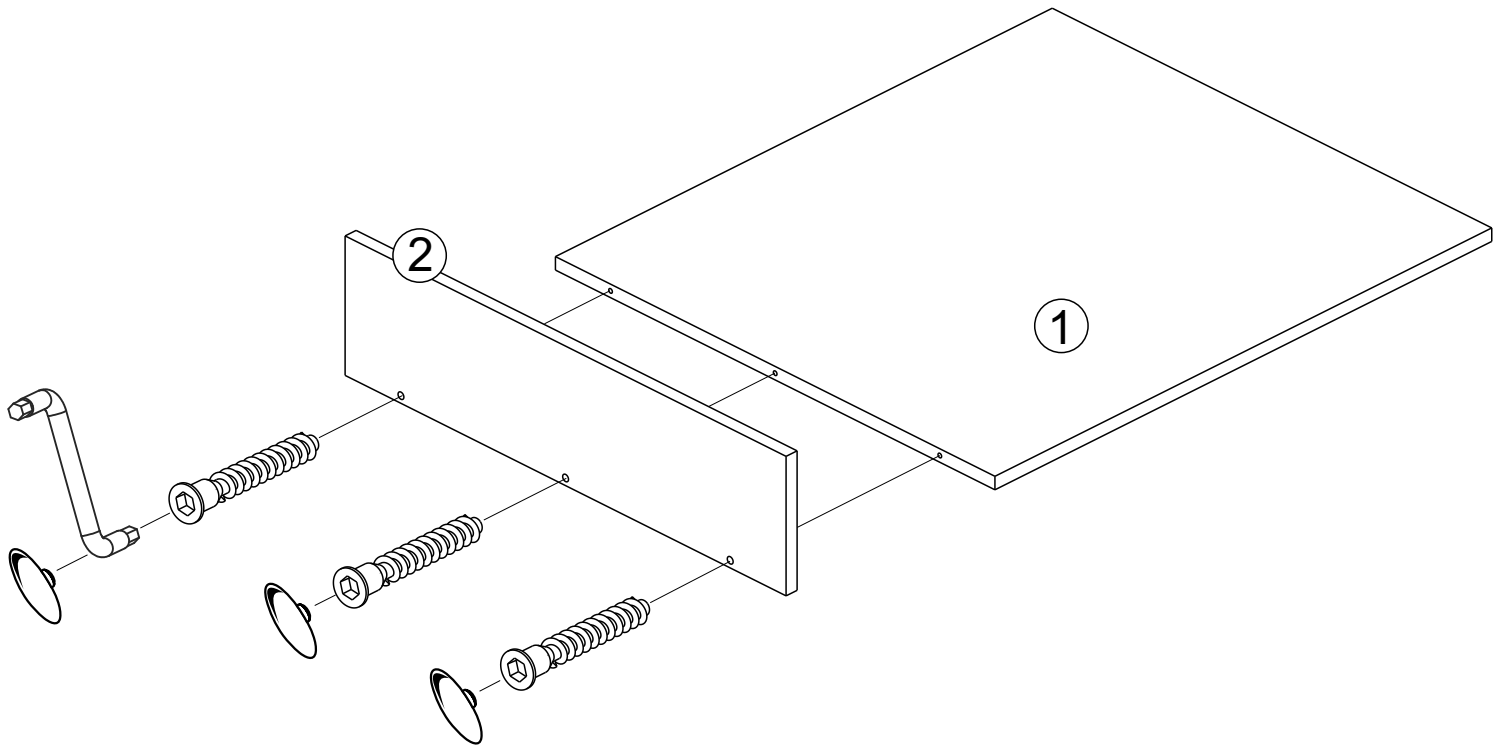
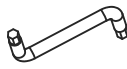
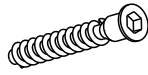

3

559

X2

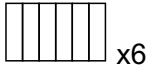

x6

