

REP	DIM	QTE
1	1847x326	1
2	1847x326	1
3	283x325	4
4	485x309	1
5	283x280	3
6	566x309	1
7	309x236	1
8	775x160	1
9	260x250	1
10	1749x310	1

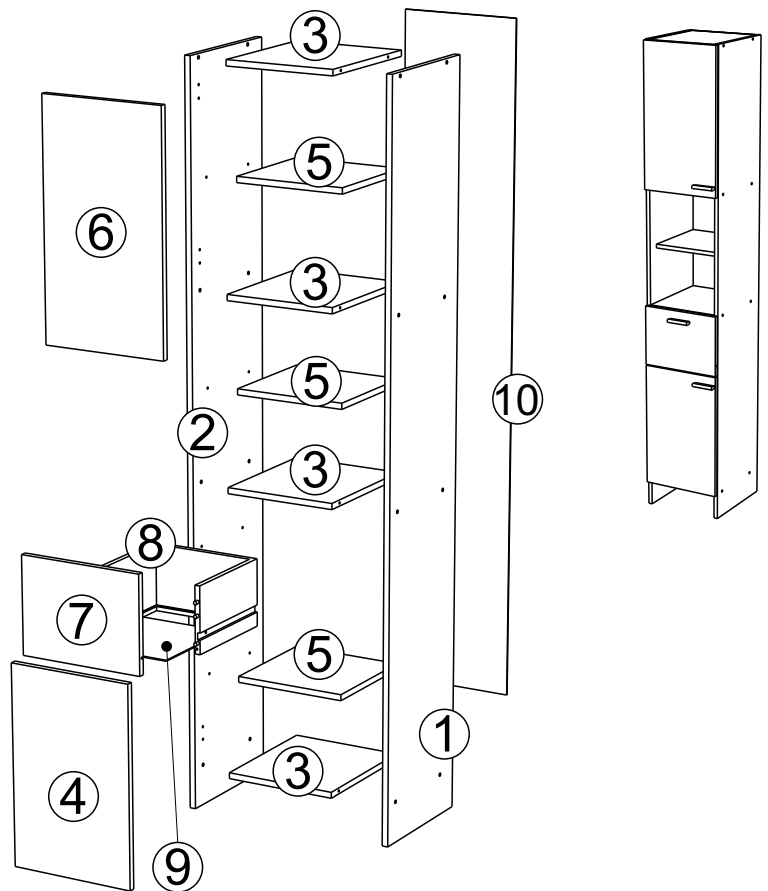

1H 00 Mn



(FR) SECURITE
IMPORTANT-A LIRE SOIGNEUSEMENT-A CONSERVER
POUR CONSULTATION ULTERIEURE

(GB) CAUTION
IMPORTANT-TO BE READED CAREFULLY-TO BE
CONSERVED FOR LATER CONSULTATION

(DE) SICHERHEITSVORSCHRIFTEN
WICHTIG-GENAU DURCHZULESEN-AUFZUBEWAHREN
FÜR SPÄTEREN GEBRAUCH

(ES) SEGURIDAD
IMPORTANTE-LEER CON ATENCION-CONSERVAR
PARA CONSULTAS POSTERIORES

(NL) VEILIGHEID
BELANGRIJK-ZORGVULDIGGELEZEN TE WORDEN-BEWAARD
TE WORDEN VOOR LATERE RAADPLEGING

(IT) SICUREZZA
IMPORTANTE-DA LEGGERE ATTENTAMENTE-DA
CONSERVARE PER CONSULTAZIONE ULTERIORE

(PT) SEGURANCA
IMPORTANTE-PARA LER COM ATENCAO-PARA
CONSERVAR PARA COOSULTA ULTERIOR

(PL) UWAGA
WAZNE-UWAZNIE PRZECZYTAC-ZACHOWAC
CELEM POZNIEJSZYCH KONSULTACJI

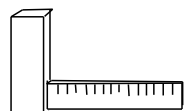
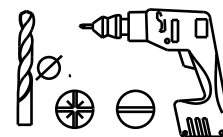
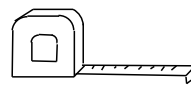
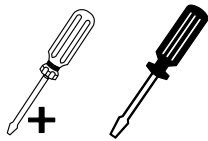

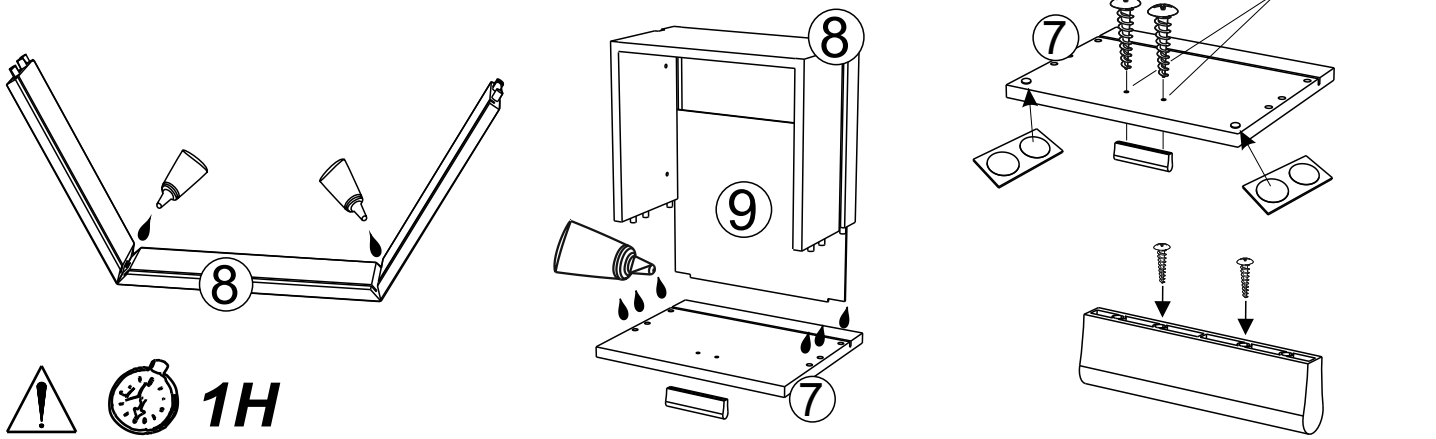

340750	X16	706	X12	340047	X2	333009	X4	333012	X4		
949	X8	434	X1	732	X1	604757	X1	560	X4		
184	X2	907	X4	332068	X3	913	X6	1107	X16	495	X1
983	X2	928	X4	8930	X3	331144	X1	700	X3		

1	732	X1	332068	X1	913	X2	8930	X1



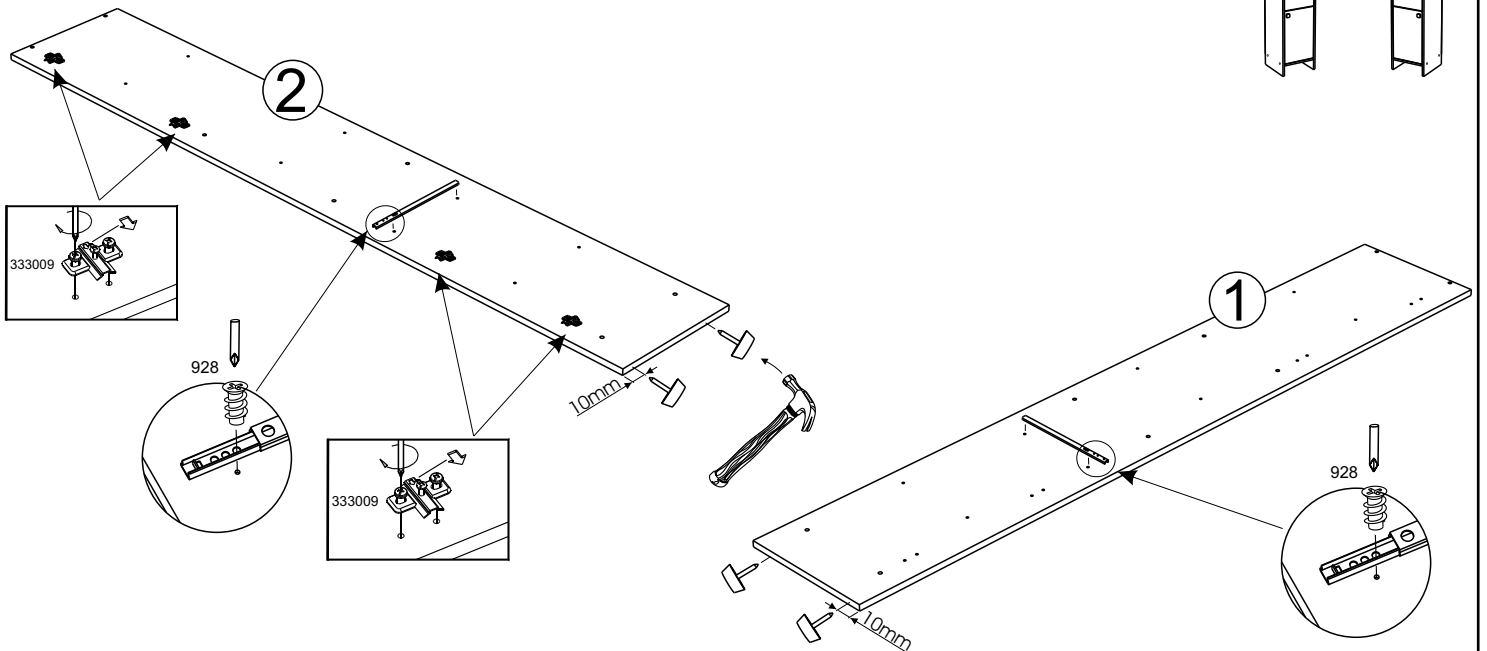

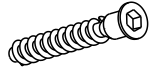
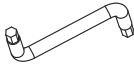

2	495	X1	928	X4	333009	X4	560	X4

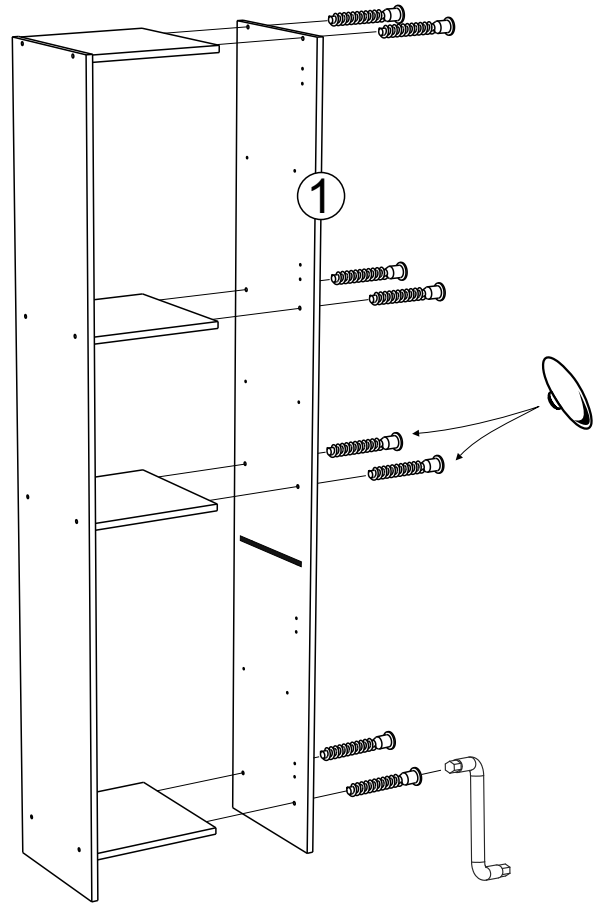
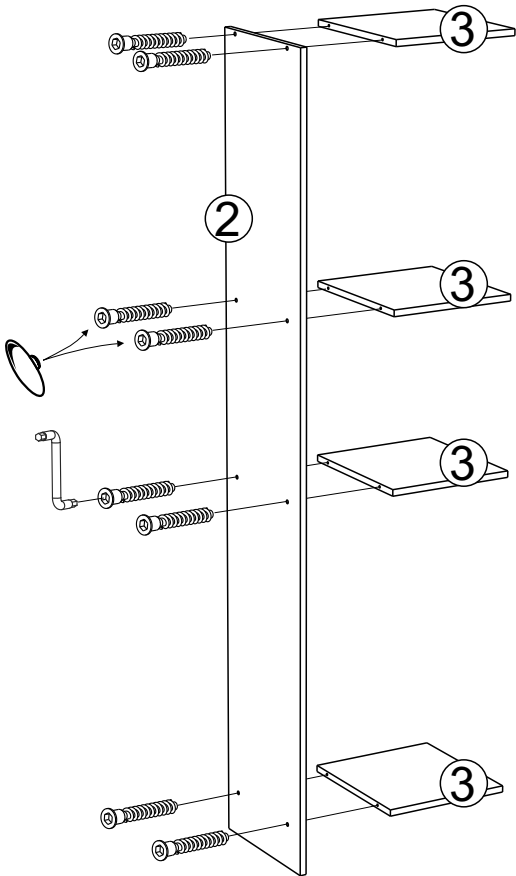

3	340750	X16	434	X1	1107	X16
						



4	604757	X1	184	X2	907	X4	331144	X1	340047	X2
		x30				3x16				

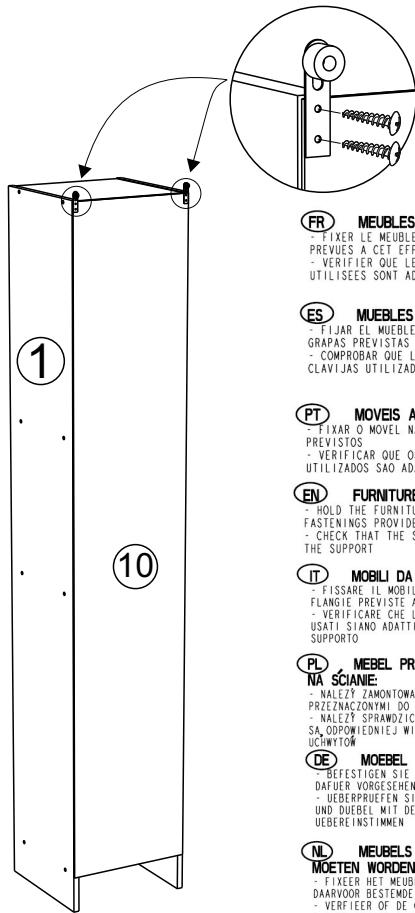
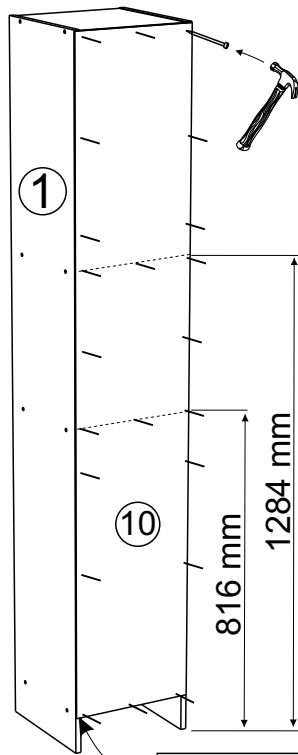
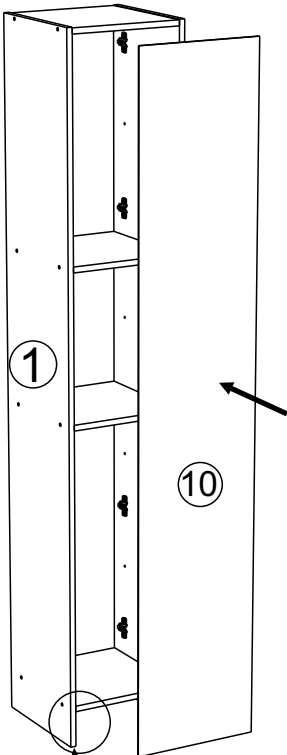

(FR) MEUBLES A FIXER AU MUR:
 - FIXER LE MEUBLE AU MUR AVEC LES ATTACHES PREVUES A CET EFFET
 - VERIFIER QUE LES VIS ET LES CHEVILLES UTILISEES SONT ADAPTEES AU SUPPORT

(ES) MEUBLES A FIJAR EN LA PARED:
 - FIJAR EL MEUBLE EN LA PARED CON LAS GRAPAS PREVISTAS
 - COMPROBAR QUE LOS TORNILLOS Y LAS CLAVIJAS UTILIZADAS SON ADAPTADAS AL SOPORTE

(PT) MOVEIS A FIXAR NA PAREDE:
 - FIXAR O MOVEL NA PAREDE COM OS PRENDES PREVISTOS
 - VERIFICAR QUE OS PARAFUSOS E AS CAVILHAS UTILIZADOS SAO ADAPTADOS AO SUPORTE

(EN) FURNITURES TO BE HOLD ON THE WALL:
 - HOLD THE FURNITURE ON THE WALL WITH THE FASTENINGS PROVIDED FOR THIS PURPOSE
 - CHECK THAT THE SCREW AND PEGS FIT WITH THE SUPPORT

(IT) MOBILI DA FISSARE AL MURO:
 - FISSARE IL MOBILE AL MURO CON LE FLANGIE PREVISTE A TALE SCOPO
 - VERIFICARE CHE LE VITI ED I PERNI USATI SIANO ADATTI A QUEL TIPO DI SUPPORTO

(PL) MEBEL PRZEZNACZONY DO ZAINSTALOWANIA NA SCIANIE:
 - NALEZY ZAMONTOWAC TEN MEBEL NA SCIANIE PRZEZNACZONYMI DO TEGO CELU UCHWYTAMI
 - NALEZY SPRAWDZIC CZY SRUBY I KOSZULKI SA ODPOWIEDNIEJ WIELKOSCI W STOSUNKU DO UCHWYTOW

(DE) MOEBEL AN DER MAUER ZU BEFESTIGEN:
 - BEFESTIGEN SIE DAS MOEBELSTUECK MIT DEN DAFUER VORGEGEHENEN BEFESTIGUNGSHAKEN
 - UEBERPRUEFEN SIE BITTE DASS DIE SCHRAUBEN UND DUEBEL MIT DEM MATERIAL DER MAUER UEBEREINSTIMMEN

(NL) MEUBELS DIE AAN DE MUUR GEFIXEERD MOETEN WORDEN:
 - FIXEER HET MEUBEL AAN DE MUUR MET DE DAARVOOR BESTEMDE HAKEN
 - VERFIEER OF DE GEBRUIKTE SCHROEVEN BIJ DE BEVESTIGINGSHAAK HOELEN

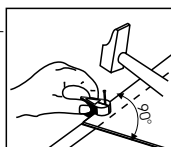
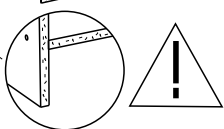

5	983	X2
----------	-----	----

6	706	X12
----------	-----	-----

7	700	X3
----------	-----	----

8	333012	X4	949	X8	332068	X2	913	X4
----------	--------	----	-----	----	--------	----	-----	----

9	8930	X2
----------	------	----