

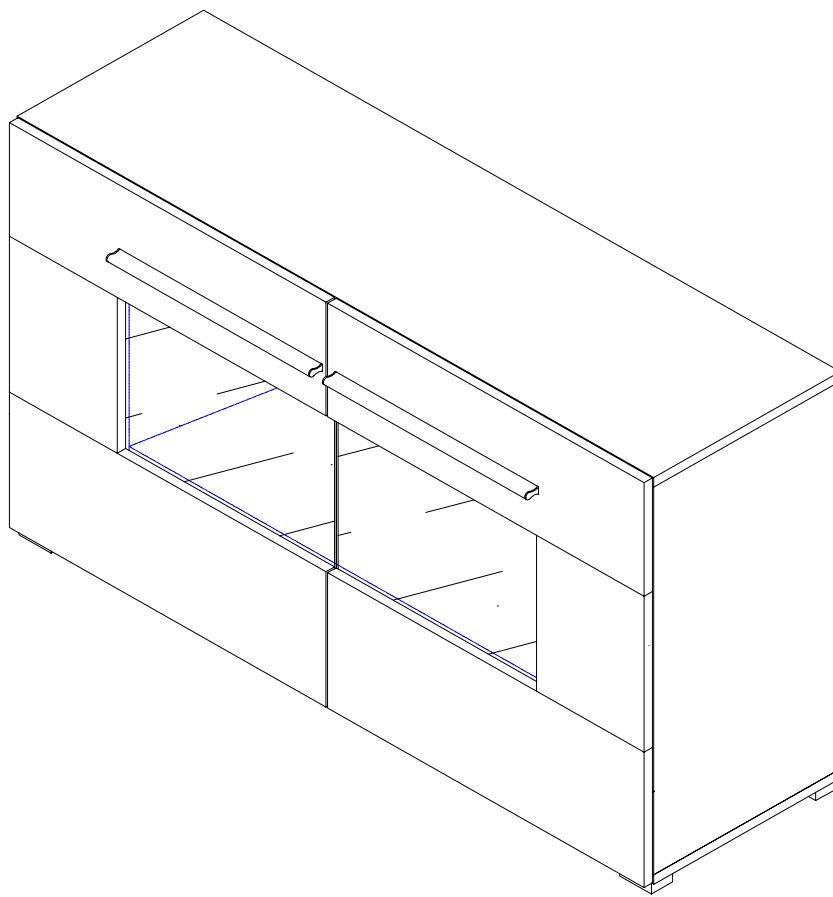

# KöLN komoda



HU

Összeszerelési útmutatót

SK

Návod na montáž

D

Montageanleitung

GB

Assembly instructions

NL

Handleiding voor de montage

PL

Instrukcja montażu

TR

Montaj talimatı

RU

Инструкция по сборке

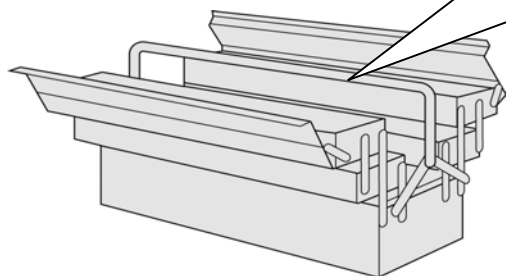
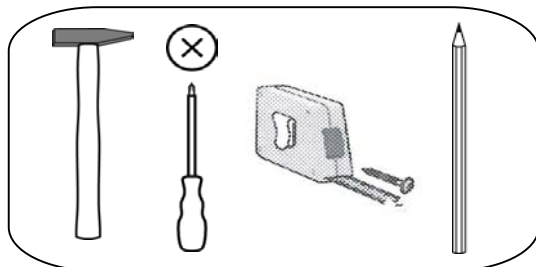
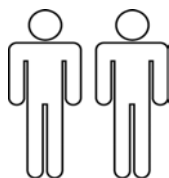

# Service•Dienstverlening•Serwis•Servis•Сервисная служба•Szerviz

Name•Naam•Nazwa•Isim•Название•Názov•Név









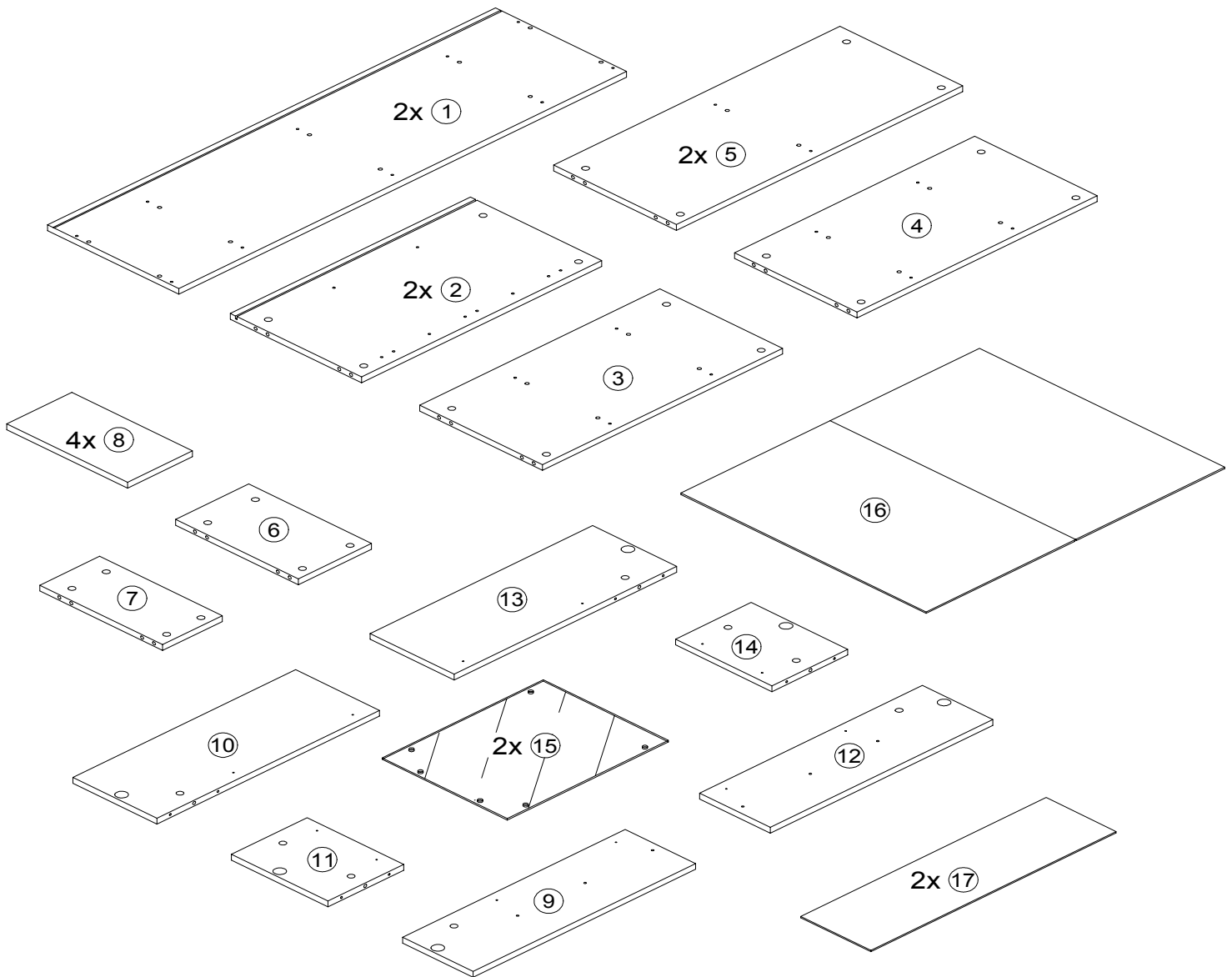
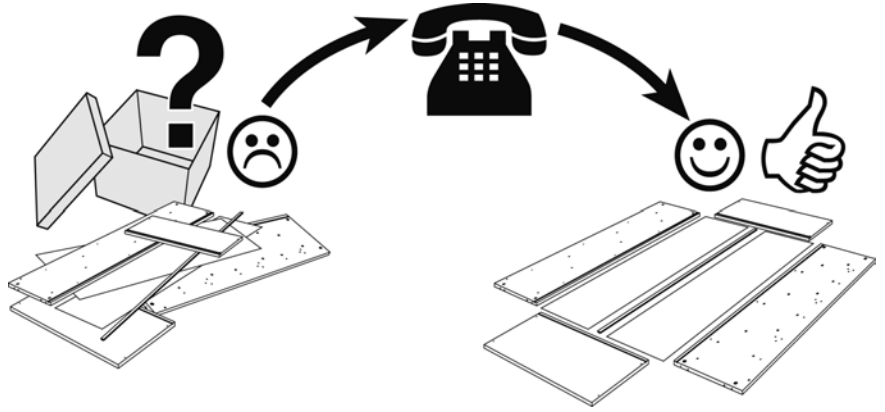
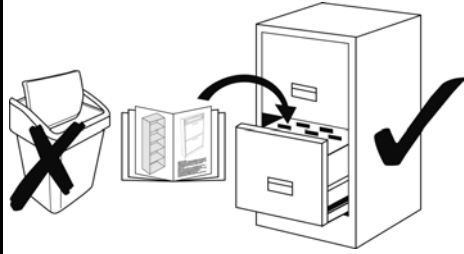







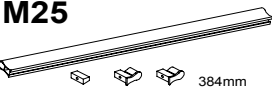

KöLN

Tур•Туре•Тір•Тип

Komoda

 Weiß Matt / Weiß Glanz  
 Schwarz Matt / Schwarz Glanz



<b>A1</b>  32	<b>A2</b>  8	<b>B1</b>  32	<b>B8</b>  4	<b>C1</b>  32 Ø8x30	<b>C7</b>  8 Ø5x50	<b>D2</b>  16	<b>E10</b>  6 2 mm	<b>F16</b>  6 Kr.0 mm	<b>K11</b>  5
<b>M25</b>  2 384mm	<b>N2</b>  22 2,7 x 20	<b>N12</b>  6 4,0 x 25	<b>P2</b>  12 3,5 x 13	<b>P9</b>  10 3,5 x 25	<b>Q4</b>  12 4,0 x 17	<b>S1</b>  32	<b>U5</b>  1	<b>X2</b>  12 10 mm	

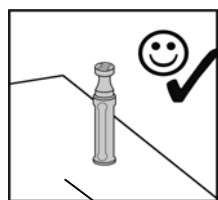
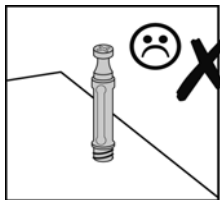

B1

