

Modellname:
Nazwa modelu:

TANGER

Modellreihe: **P8 -- 32 02**
Numer modelu:

Blatt Nr 1 von: 12
Strona z: 12

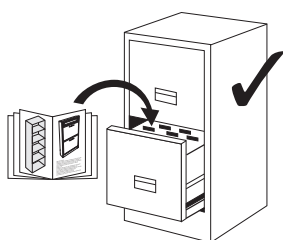
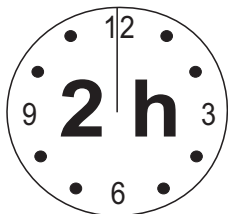

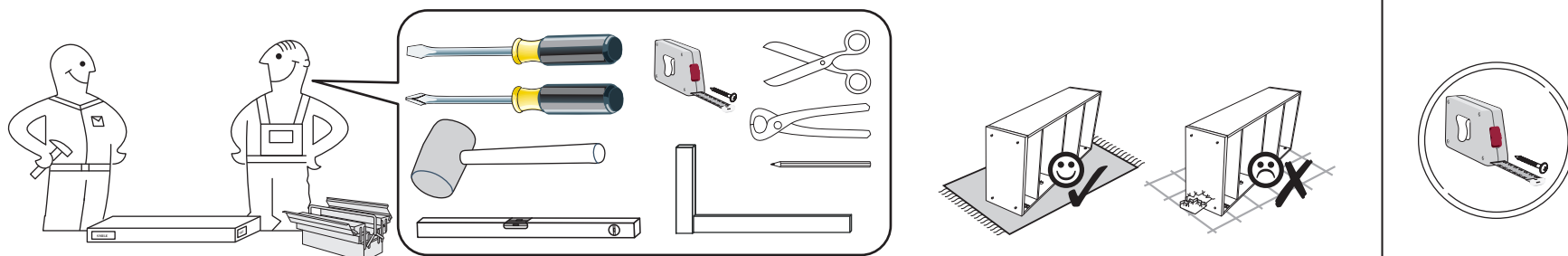
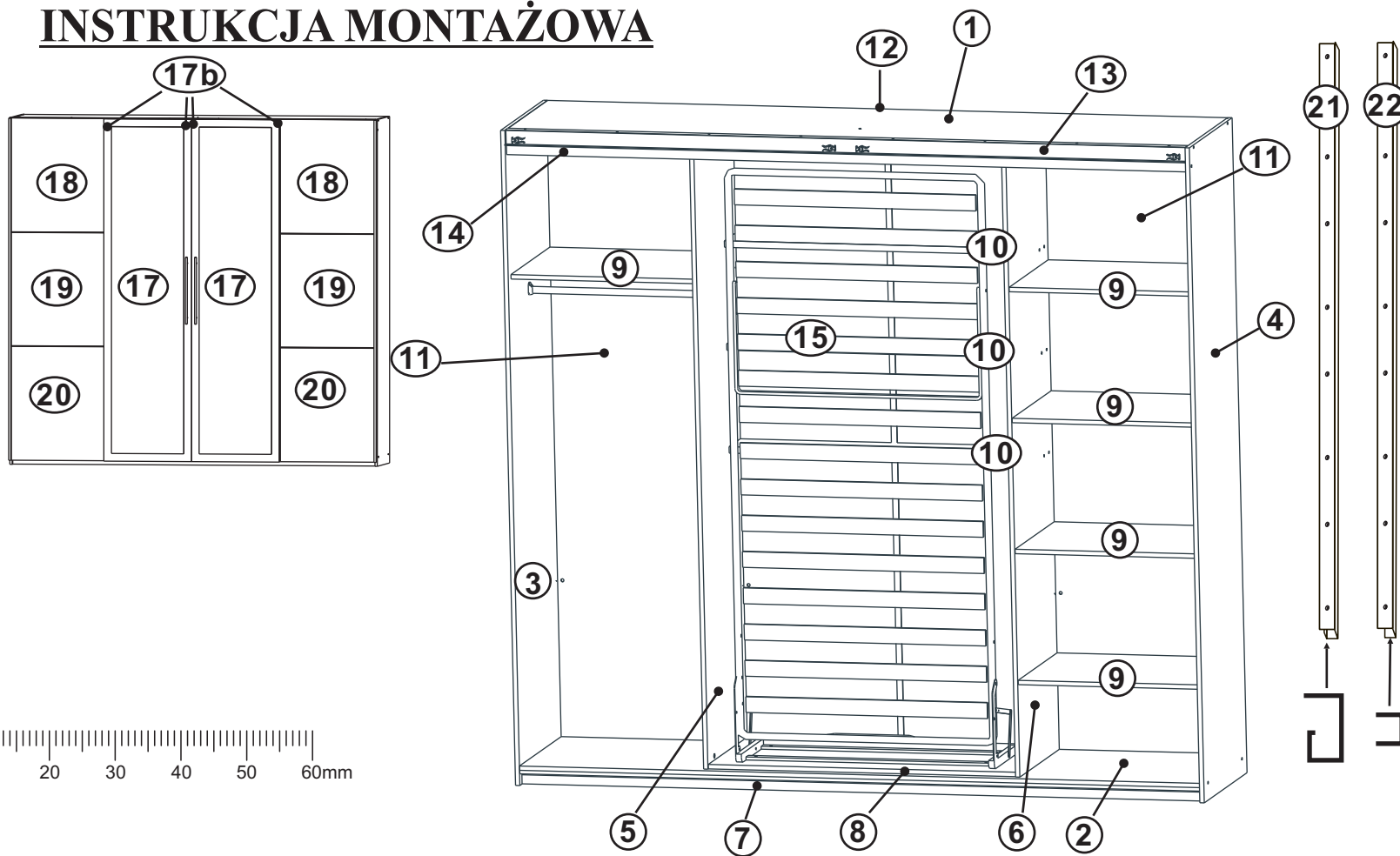

MONTAGEANLEITUNG INSTRUKCJA MONTAŻOWA





Nr 1

T6  x20

M1  X32

T1  x8

T2  X12

C2  x8

B1  ϕ 8x28 X38

B2  ϕ 8x35 X8

K1  7x50 X24

C1  ϕ 2 X24

S16  4x50 x2

Nr 2

M6  X14

P16  3,5x16 X14

L4  x4

Nr 3

F7  X2

S3  3,5x13 X2

Nr 4

E9  X2

E11  X2

E1  6,3x11 X10

Nr 5

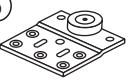
E5  X2

E1  6,3x11 X10

Nr 6

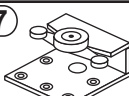
E7  X4

E1  6,3x11 X20

Nr 7

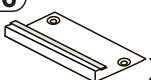
E6  X4

E1  6,3x11 X8

Nr 8

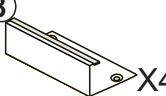
E8  X4

E1  6,3x11 X8

Nr 9

L1  X1

S3  3,5x13 X8

S3  3,5x13 X40

F12  X16

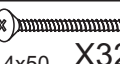
S16  4x50 X32

Nr 10

P13  3,5x13 mm X4

J11  x2

Nr 11

U75  x2

A6  WPM4x40 X4

Nr 12

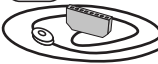
O21  x1

SQR  X1

Nr 13

G7  X1





G17  X4

G10  X4

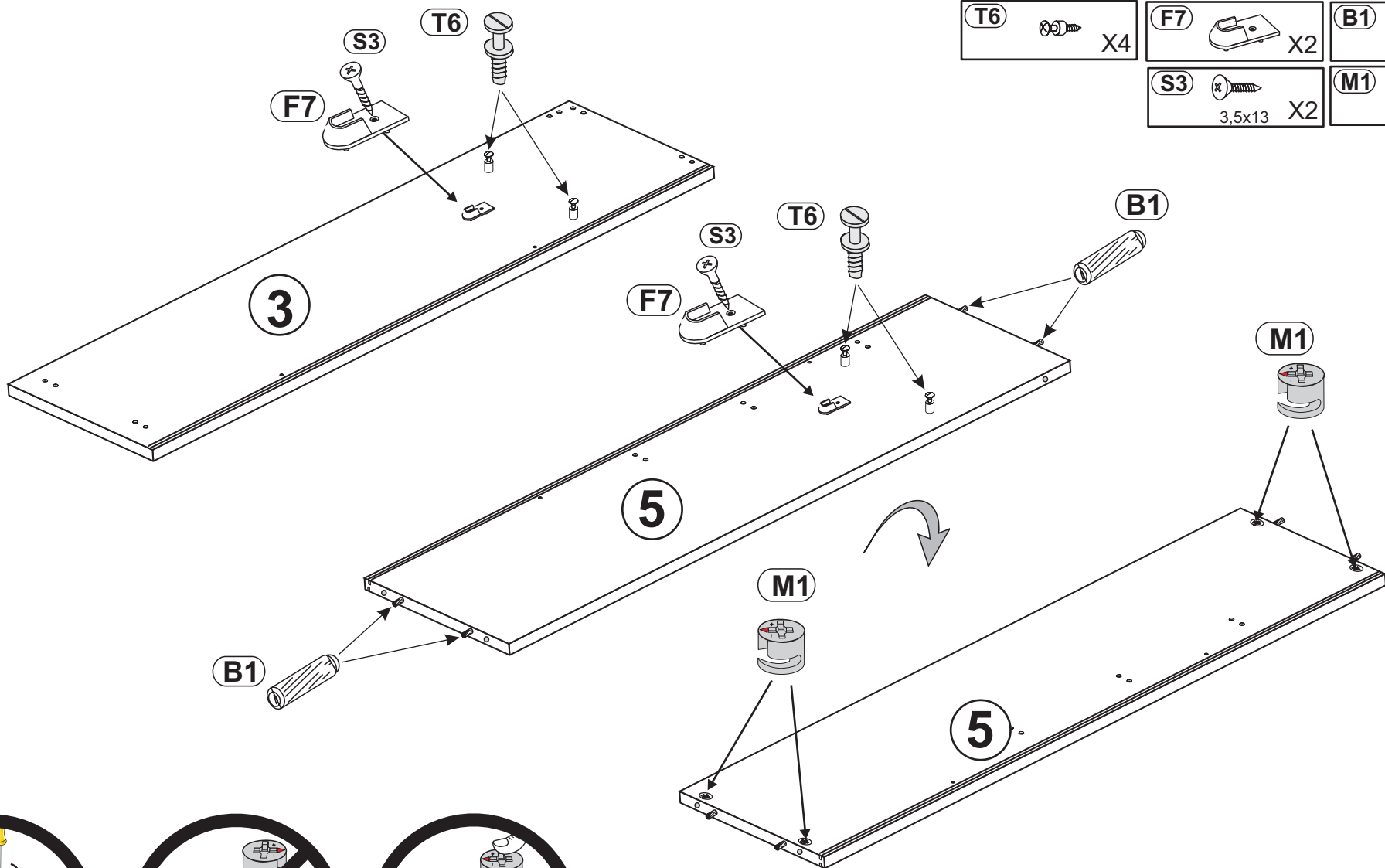

1



T6  X4	F7  X2	B1  ϕ 8x28 X4
S3  3,5x13 X2	M1  X4	



Modellname:
Nazwa modelu:

TANGER

Modellreihe: **P8 -- 32 02**
Numer modelu:

Blatt Nr **4** von: **12**
Strona z: **12**

2

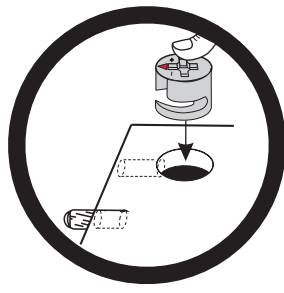
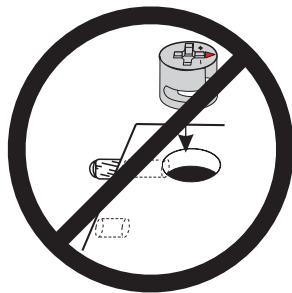
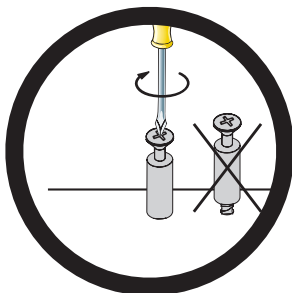
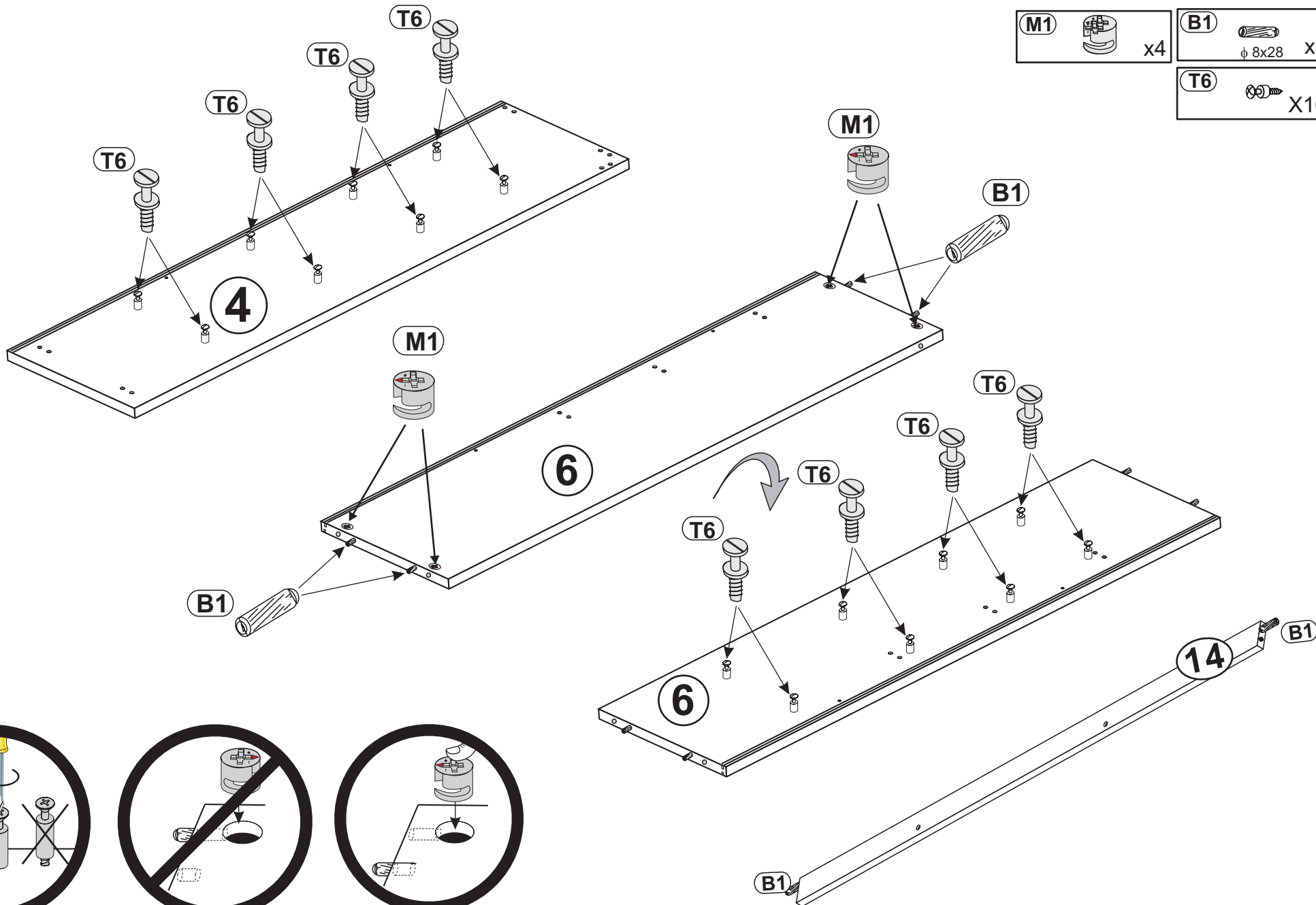



Modellname:
Nazwa modelu:

TANGER

Modellreihe: **P8 -- 32 02**
Numer modelu:

Blatt Nr **5** von: **12**
Strona z: **12**



3

- T1**  x8
- B1**  ϕ 8x28 x10

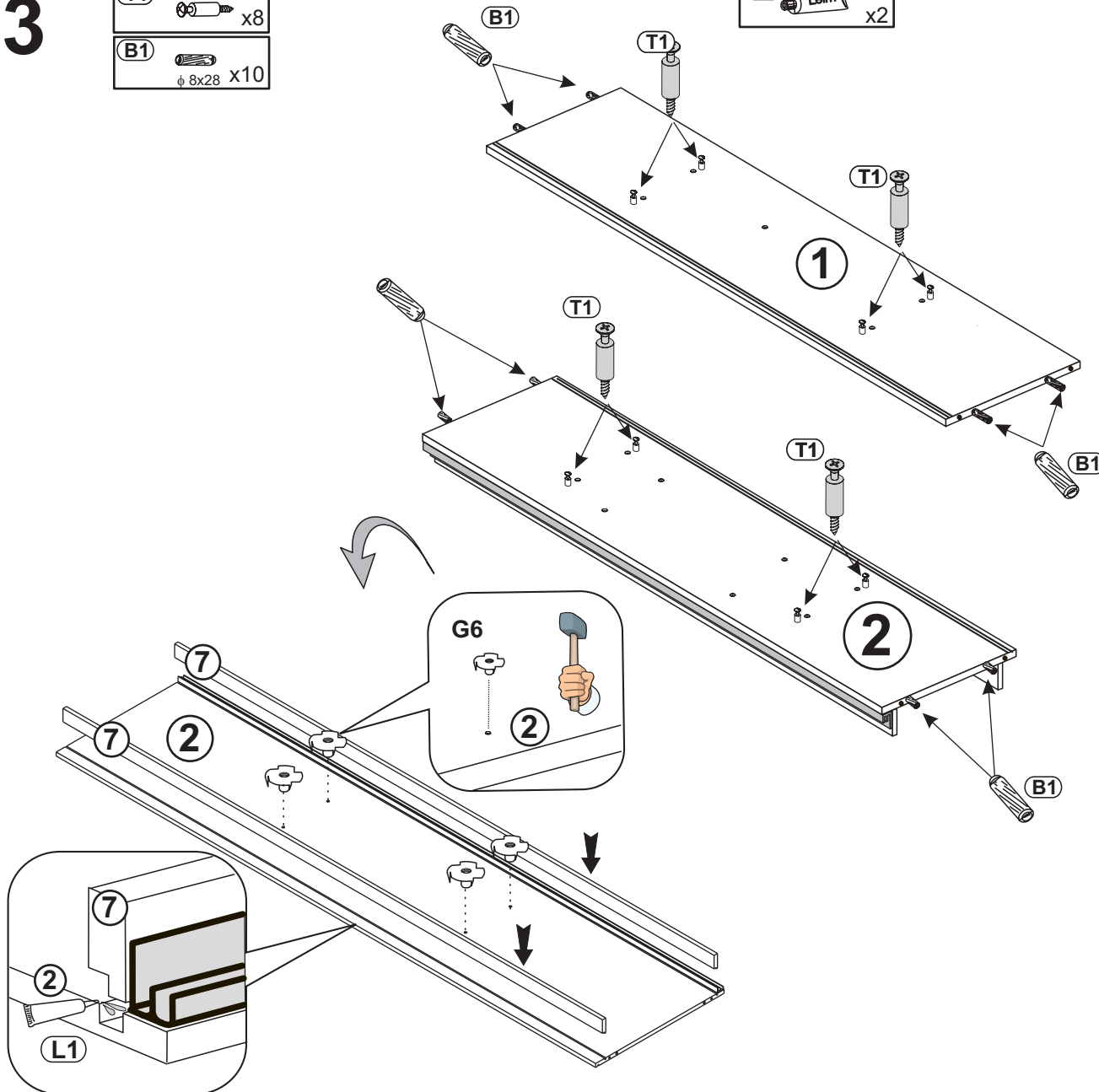
- L1**  Leim x2



4

- K1** 
- C1** 

-  7x50 x12

-  ϕ 2 x12

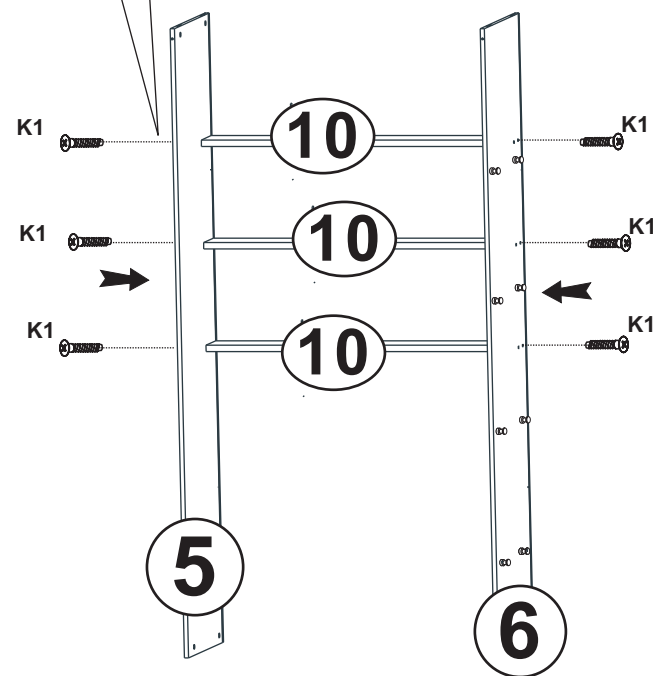

5

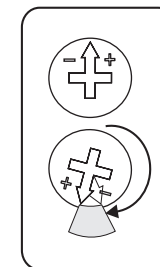
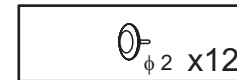
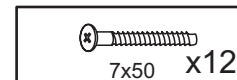
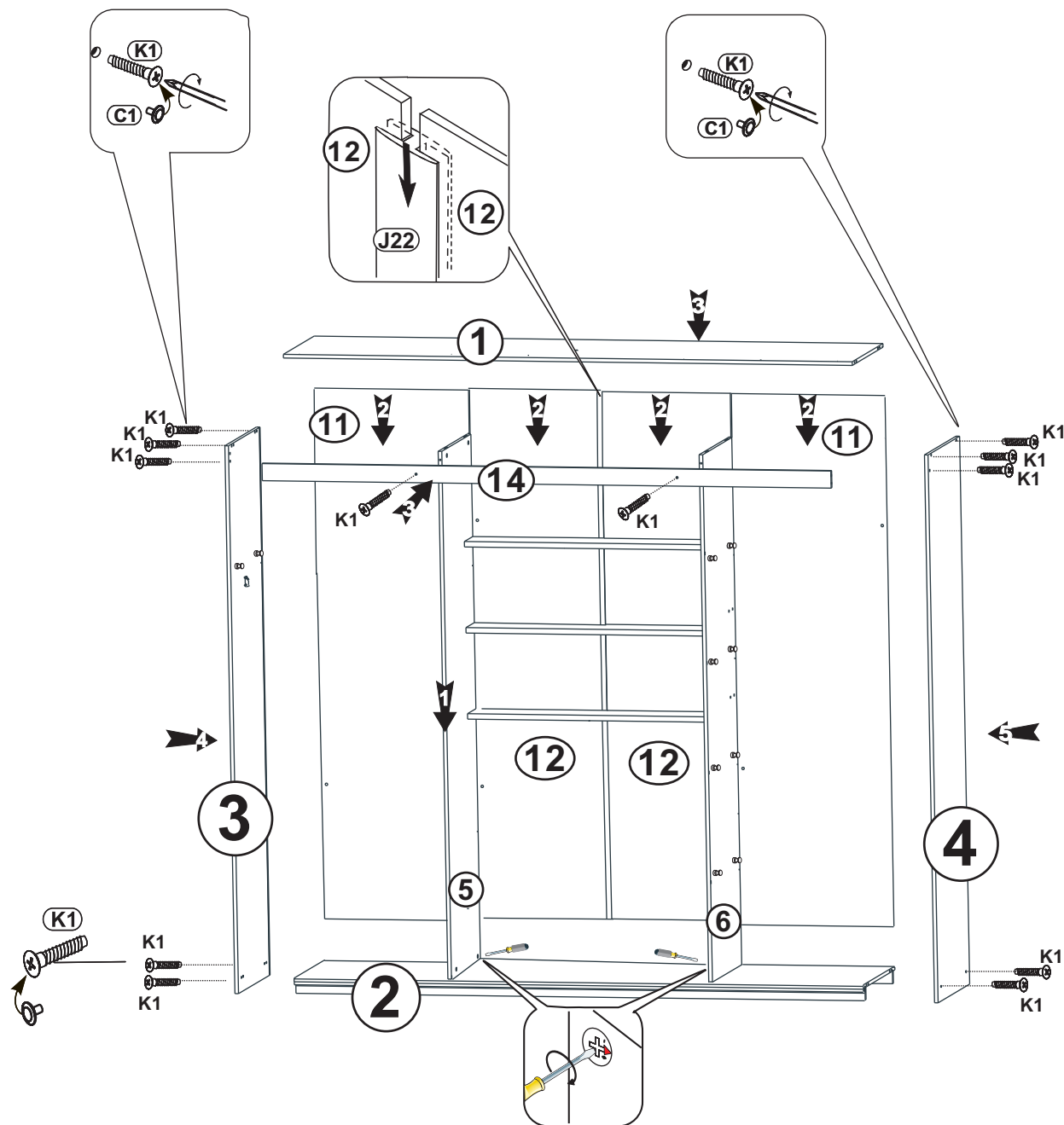

10

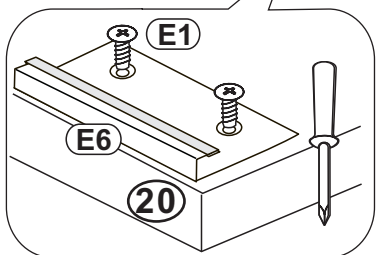
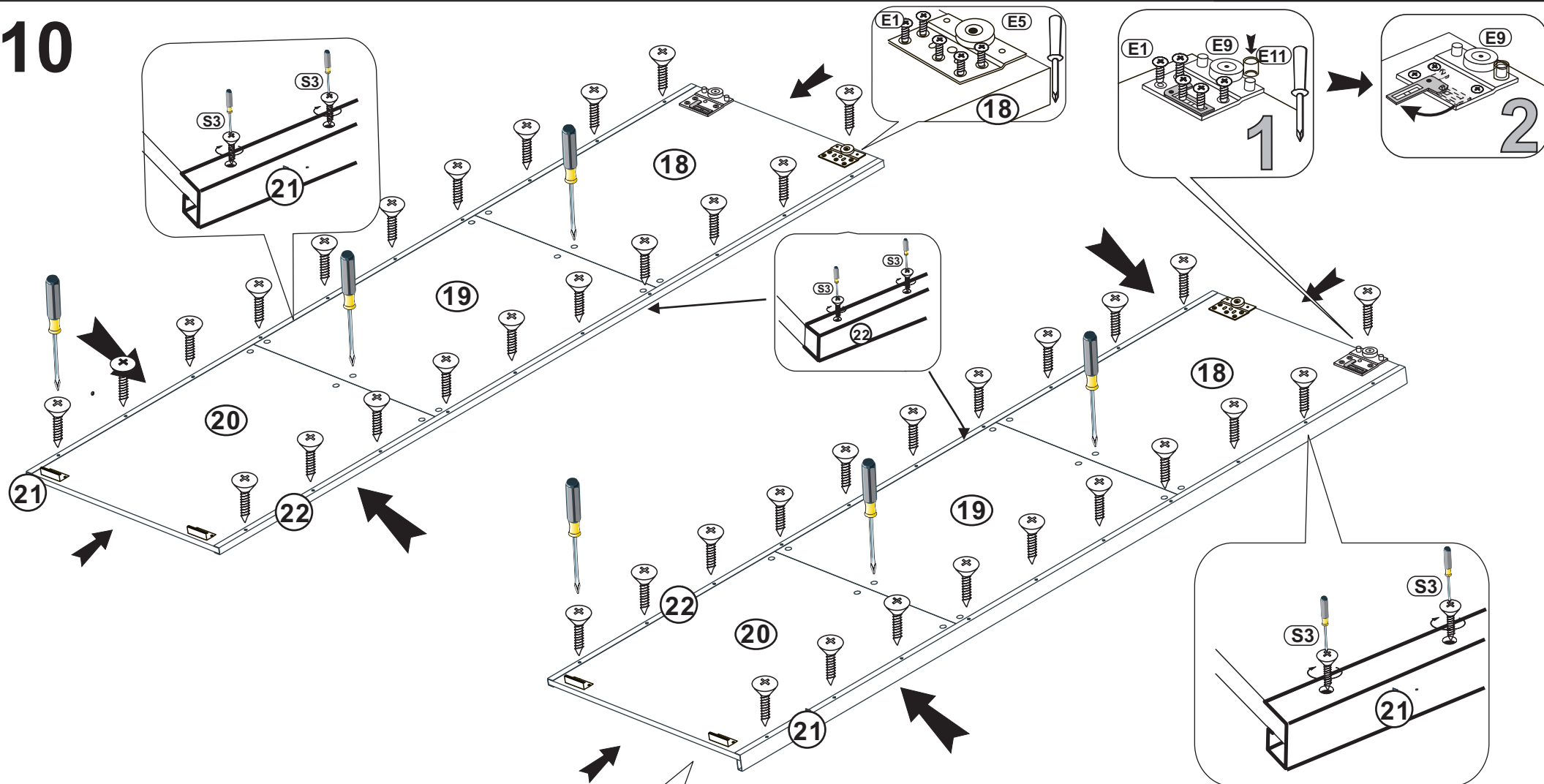

- | | | | | | | | | | |
|------------|--|----|-----------|--|--------|-----|-----------|--|----|
| E11 | | X2 | E1 | | 6,3x11 | x28 | E5 | | X2 |
| E6 | | X4 | S3 | | 3,5x13 | X40 | E9 | | X2 |

11

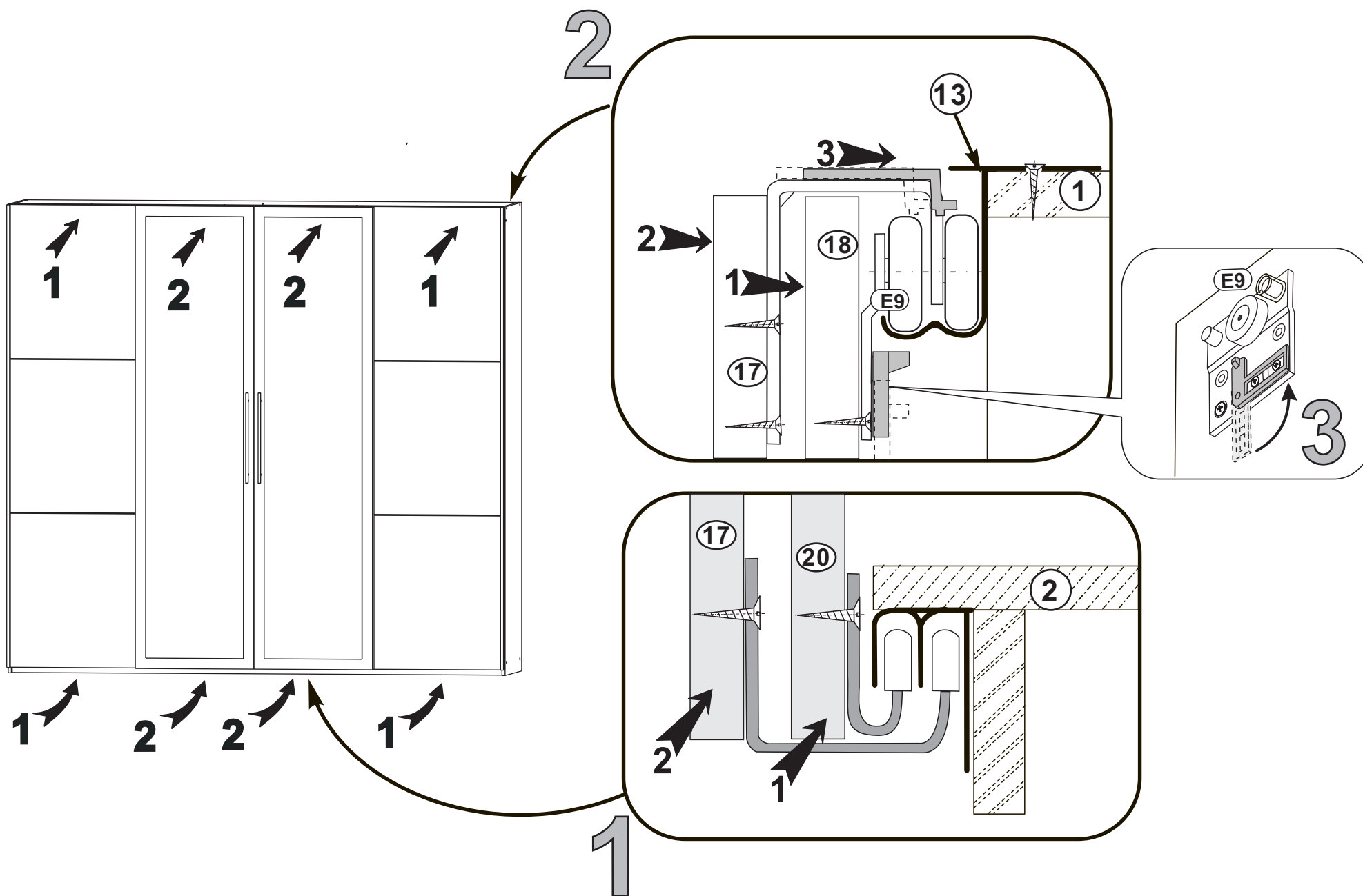

12

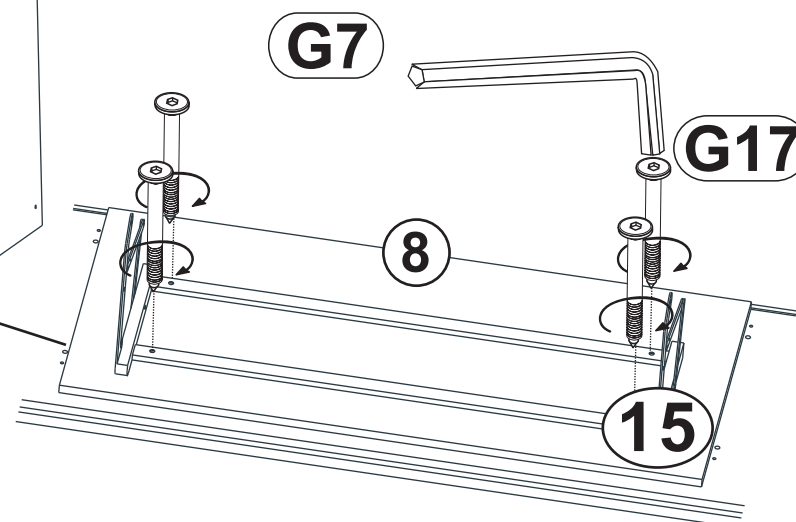
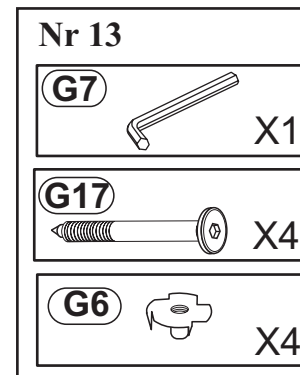
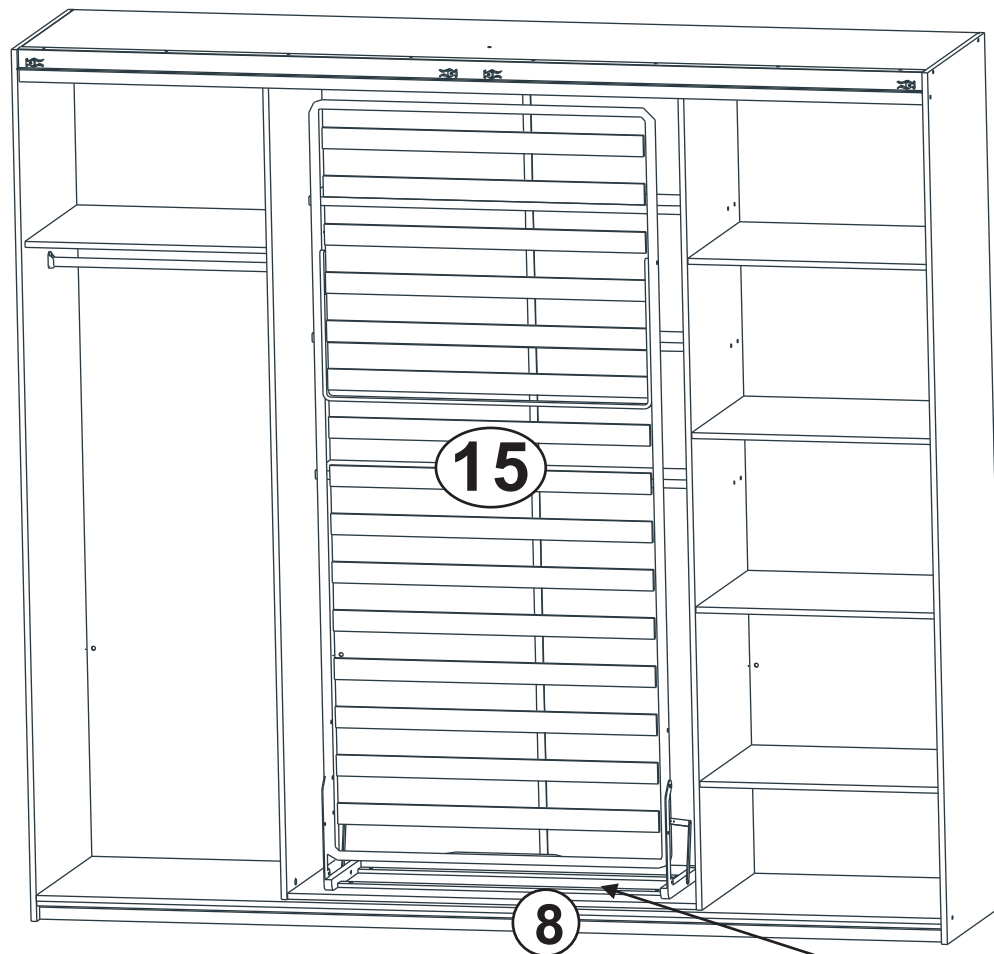

13

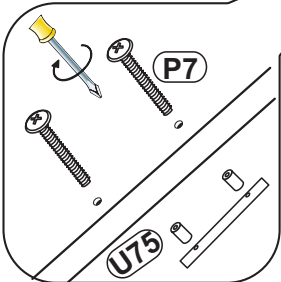
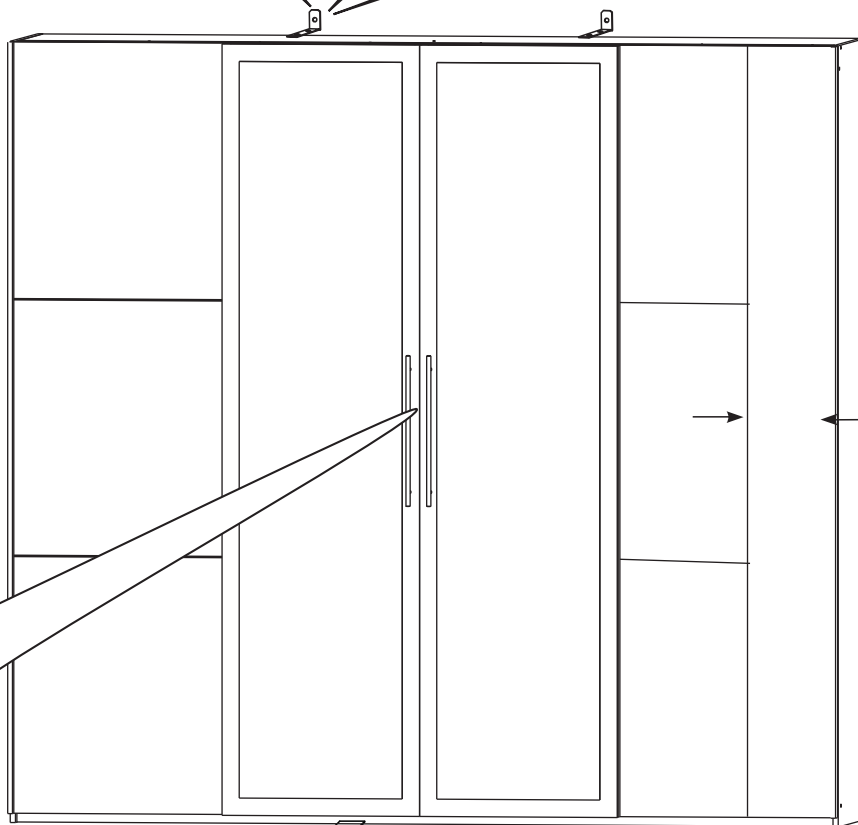
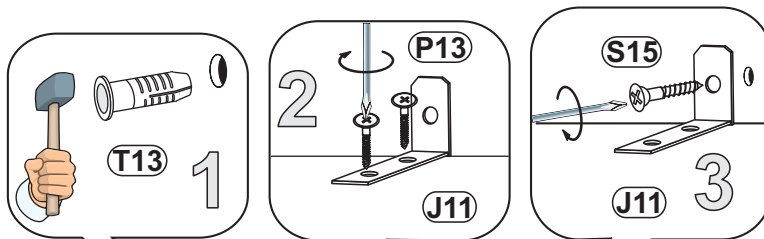
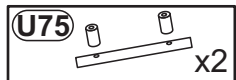

- PL** Załączone kołki do zawieszania bryły, do stosowania wyłącznie do ścian betonowych, do innych ścian należy odpowiednio dokupić.
- GB** Attached dowels to hang up unit are for concrete walls only. For other types of walls, appropriate dowels must be purchased
- D** Die beigefügten Dübel zum Aufhängen des Elements dürfen nur bei Betonwänden eingesetzt werden, bei anderen Wandarten müssen entsprechende Dübel zugekauft werden.
- F** Les chevilles jointes, pour pendre l'élément, sont pour les murs bétonnés exclusivement; pour autres murs il faut acheter chevilles adéquates

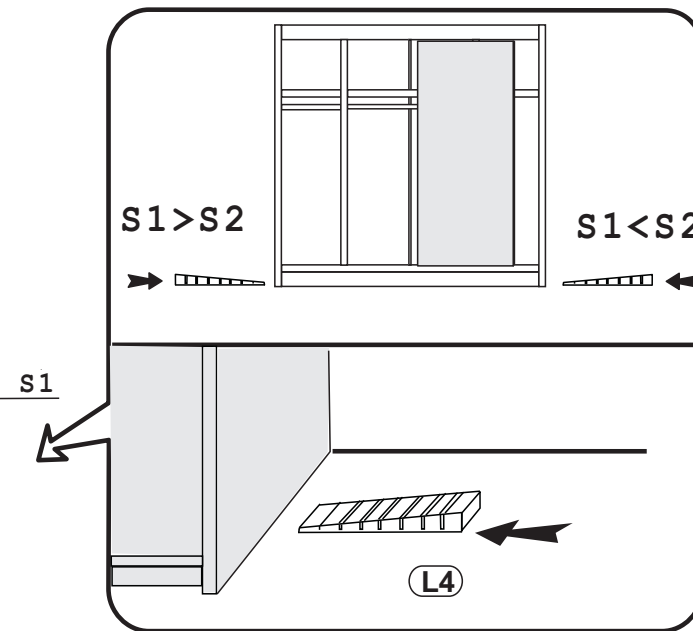
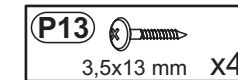
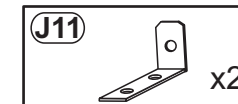
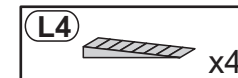

C4 -- T1 12/12

