

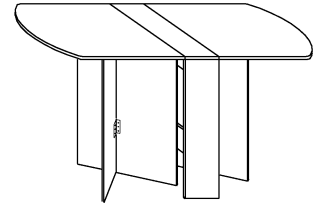

# EXPERT 2

→ 22/86/150+75/80



x 8



(a)

x 4



(b)

x 4



(c)

x 8



(d)

x 84 (3,5 x 16)



(e)

x 8 (6,2 x 13)



(f)

x 14



(g)

x 1



(h)

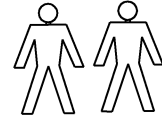
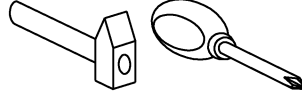

30 min

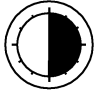

① - FAZY MONTAŻU

Ⓐ - OZNACZENIE ELEMENTÓW

Ⓐ - OZNACZENIE AKCESORIÓW

①

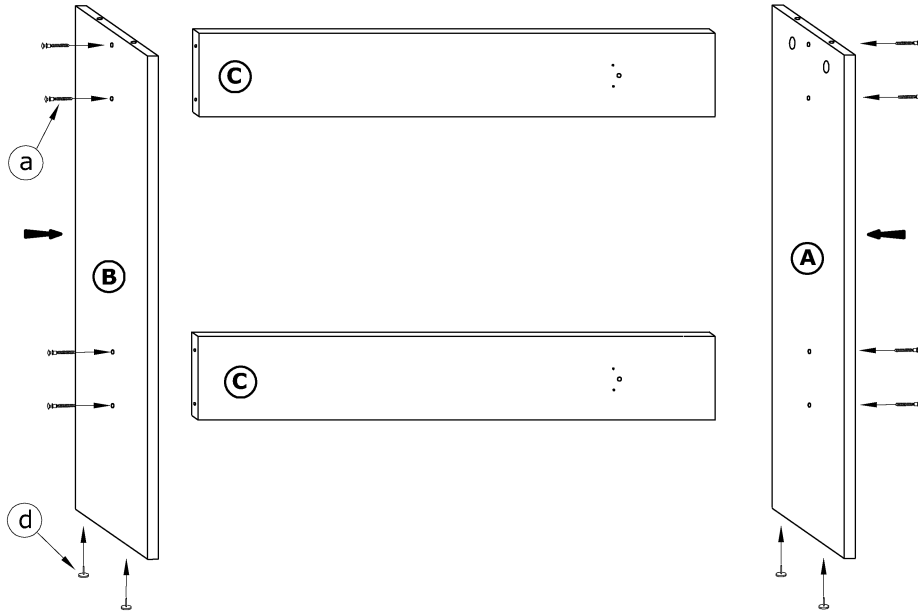

②

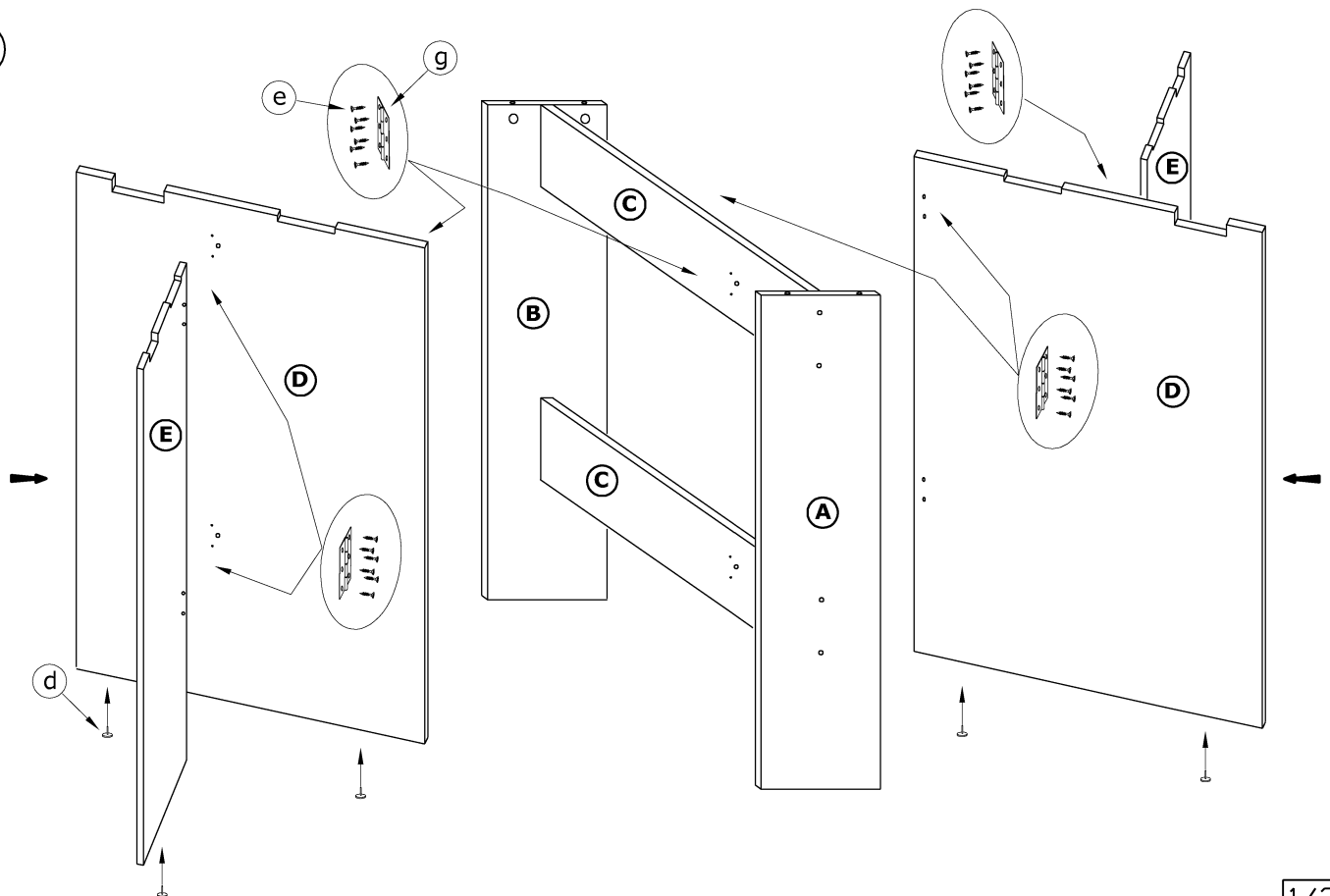

3

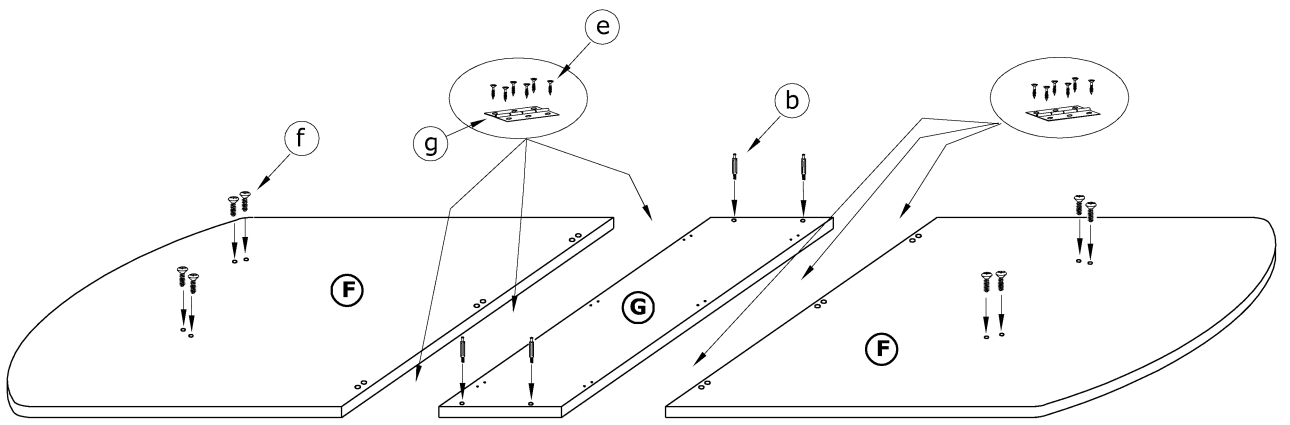

4

