

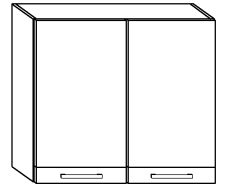

POLO - W80

→ 80 ↑ 72 ↘ 34



x 8



x 4

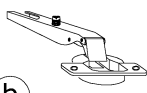

x 4

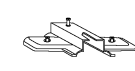

x 2



(a)

(b)

(c)

(d)

x 4



x 2



x 8 (4x16)



x 4 (3,5x30)



(e)

(f)

(g)

(h)

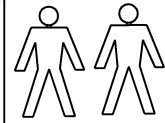

25 min

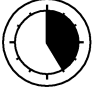

x 15

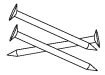

x 1



x 1

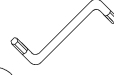

x 1 688mm

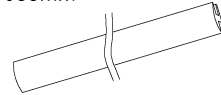

(j)

(k)

(l)

(m)

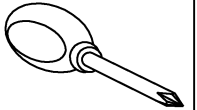
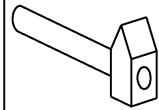

1 - FAZY MONTAŻU

A - OZNACZENIE ELEMENTÓW

a - OZNACZENIE AKCESORIÓW

1

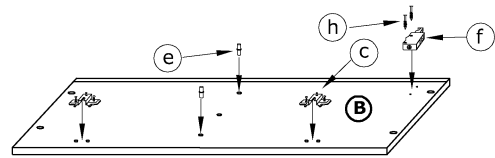
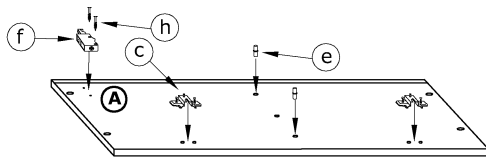

2

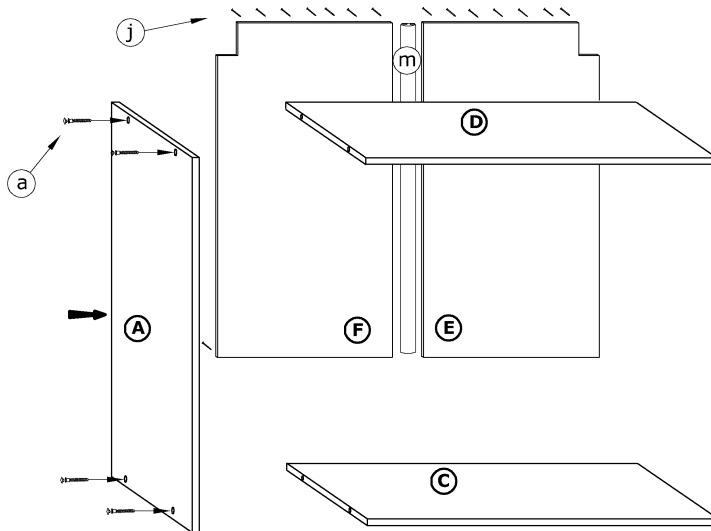

3

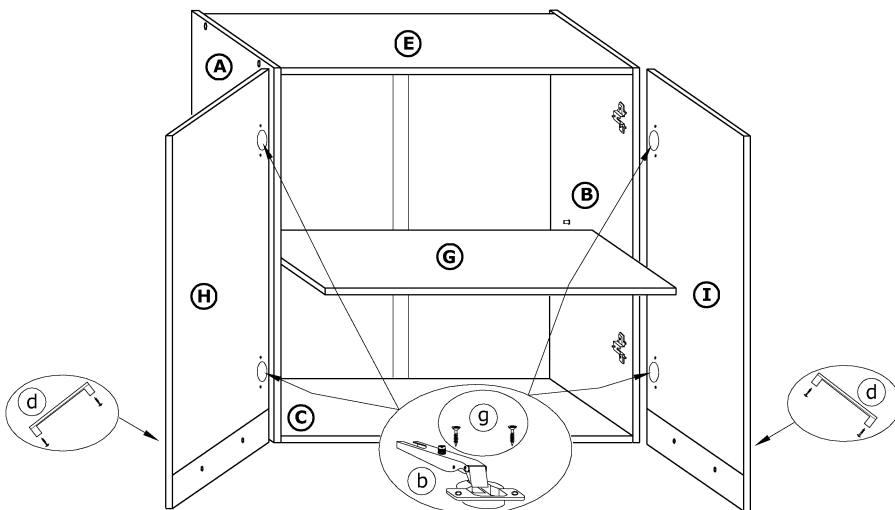

4

