

PRZED ROZPOCZĘCIEM MONTAŻU ZAPOZNAĆ SIĘ Z INSTRUKCJĄ

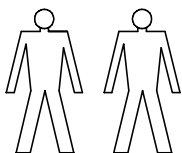

Narzędzia niezbędne do montażu (nie dostarczane przez producenta)

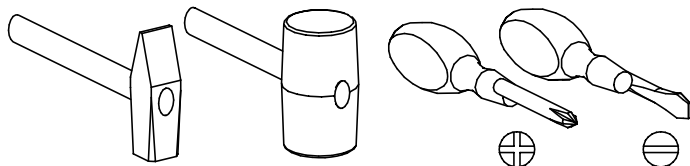

GOYA

Półka

Nr	Nazwa elementu	Dł [mm]	Szer [mm]	Gr [mm]	Ilość	Kod	Paczka
29	półka	1200	144	16	1		
30	listwa	1200	70	16	1		

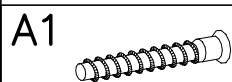
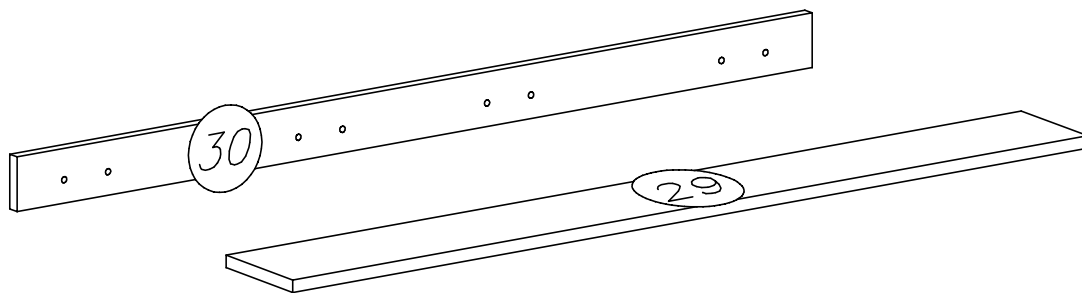
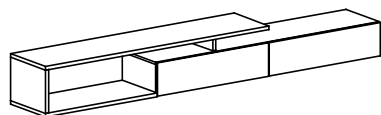
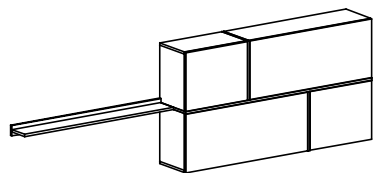

Ø7 x 50 x4

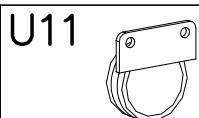

U11 x3

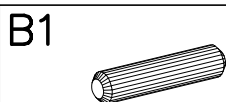

B1 x4

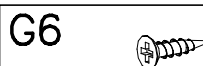

G6 3 x 13 x6

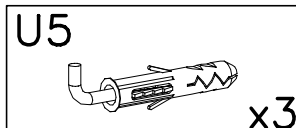

U5 x3

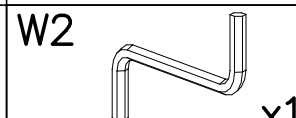

W2 x1

1

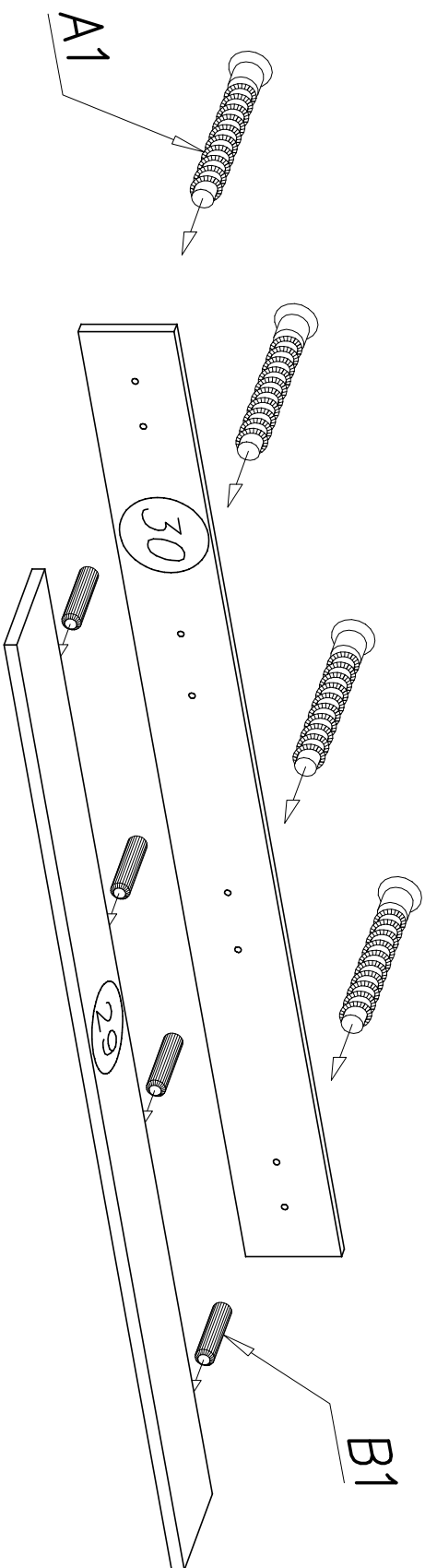

2

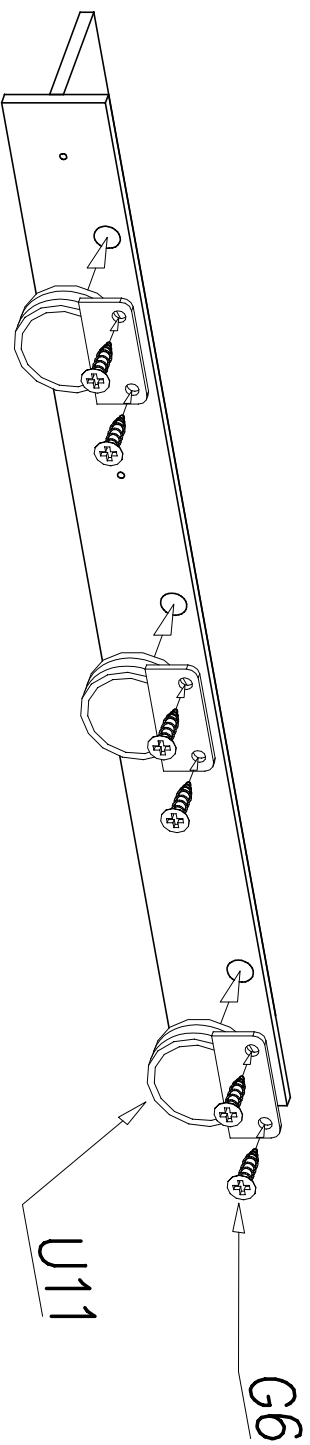

3

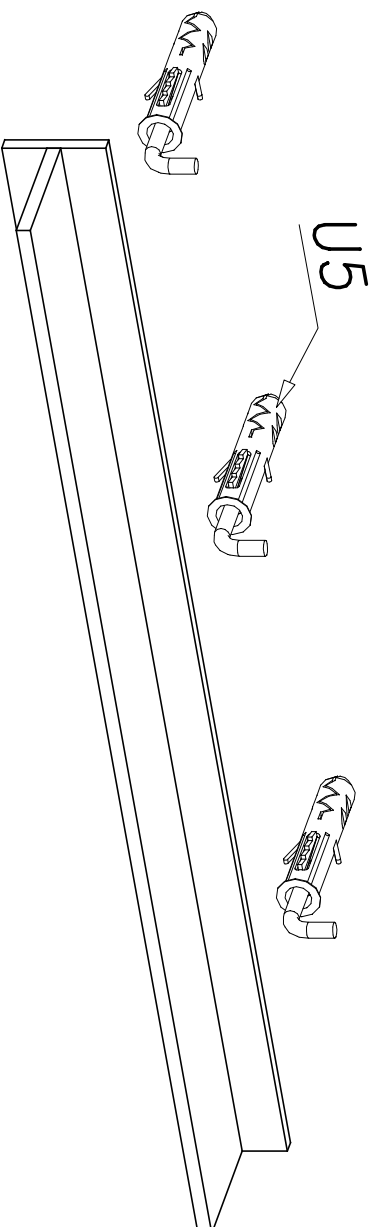

PRZED ROZPOCZĘCIEM MONTAŻU ZAPOZNAĆ SIĘ Z INSTRUKCJĄ

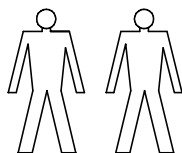

Narzędzia niezbędne do montażu (nie dostarczane przez producenta)

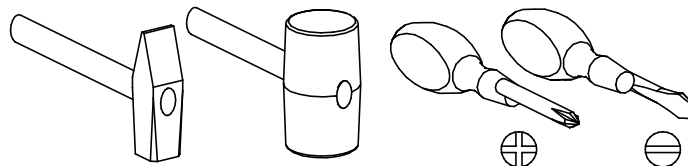

GOYA

RTV TV

Nr	Nazwa elementu	Dł [mm]	Szer [mm]	Gr [mm]	Ilość	Kod	Paczka
11	bok lewy	295	404	25	1		
12	przegroda	88	358	25	1		
13	blat górny	1800	404	25	1		
14	blat dolny	900	404	25	1		

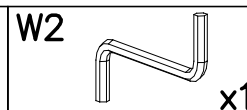
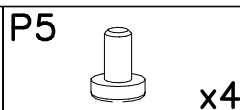
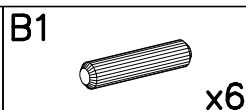
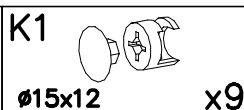
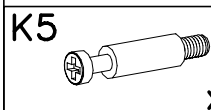
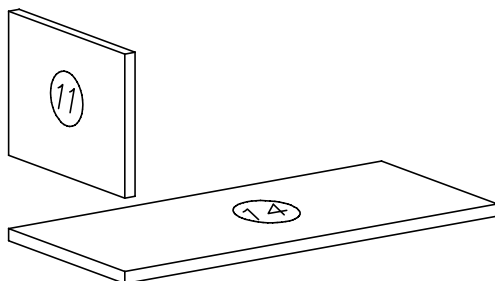
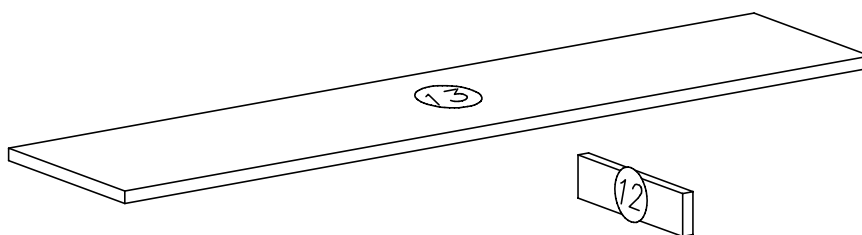
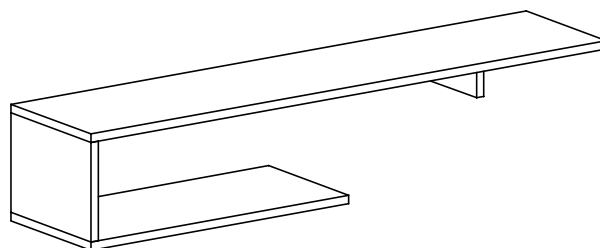
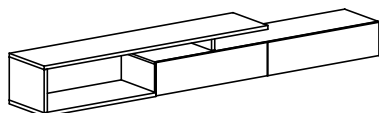
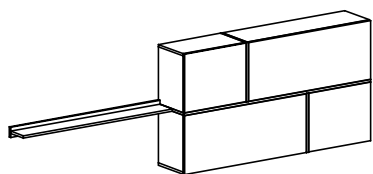

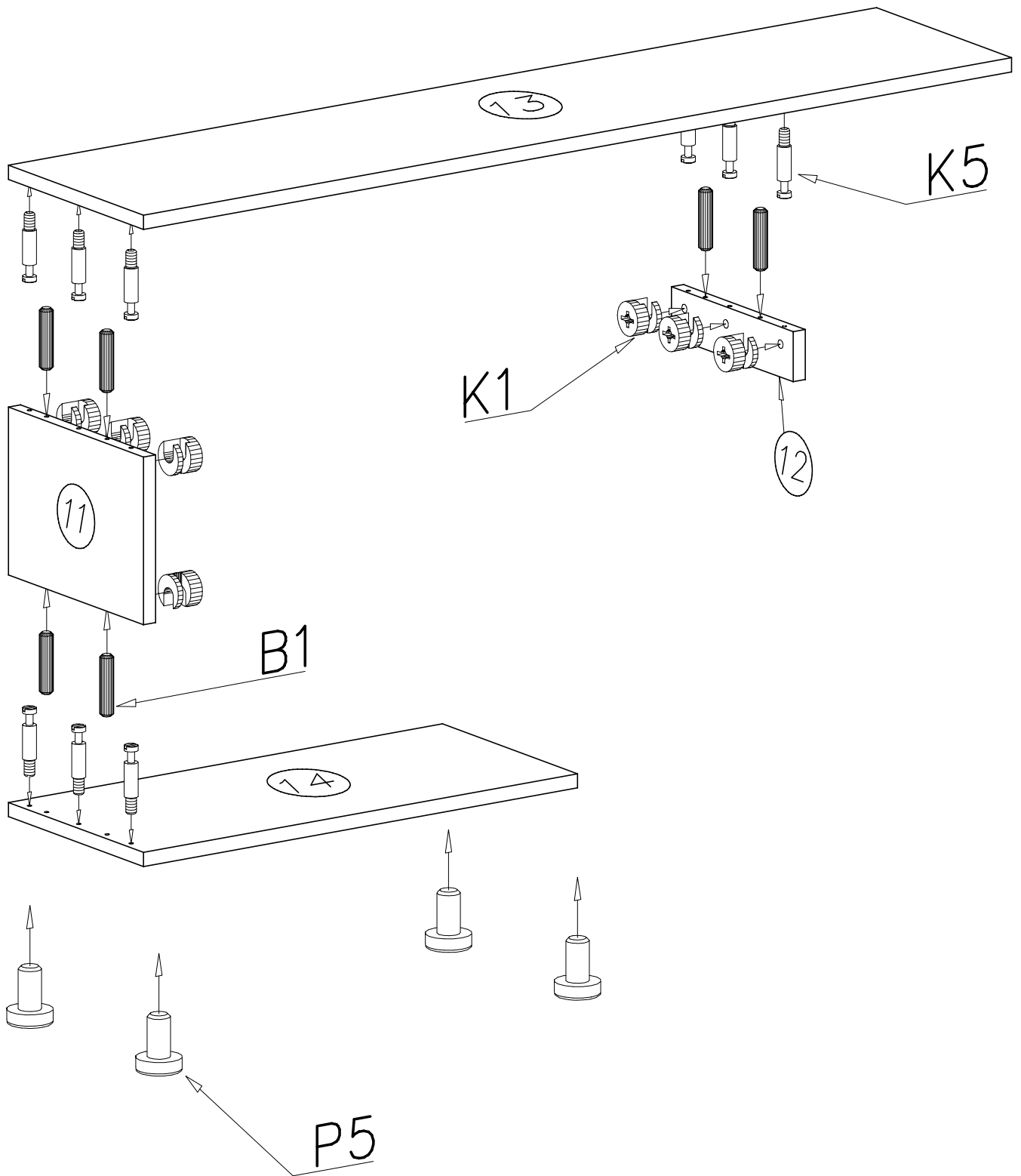
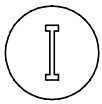

PRZED ROZPOCZĘCIEM MONTAŻU ZAPOZNAĆ SIĘ Z INSTRUKCJĄ

Narzędzia niezbędne do montażu (nie dostarczane przez producenta)

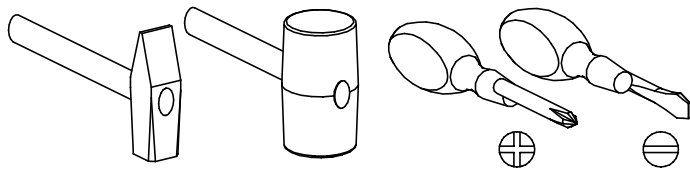
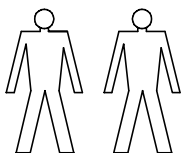

GOYA

RTV

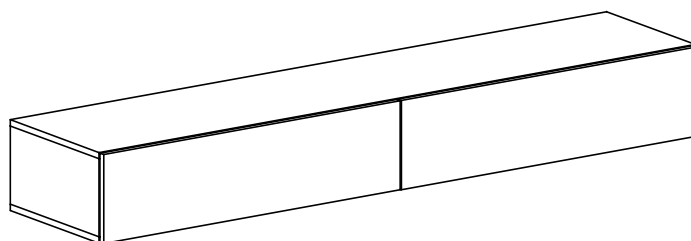
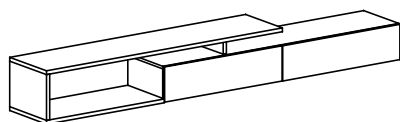
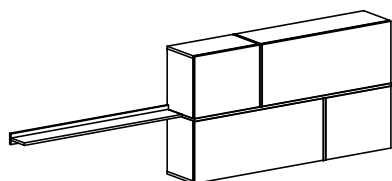

Nr	Nazwa elementu	Dł [mm]	Szer [mm]	Gr [mm]	Ilość	Kod	Paczka
1	blat górny	1800	382	16	1		
2	blat dolny	1800	382	16	1		
3	bok lewy	200	382	16	1		
4	przegroda śr.	200	379	16	1		
5	bok prawy	200	382	16	1		
6	HDF tył	1788	220	2,5	1		
7	klapa lewa	895	228	16	1		
8	klapa prawa	895	228	16	1		
9	przegroda lewa	200	379	16	1		
10	przegroda prawa	200	379	16	1		

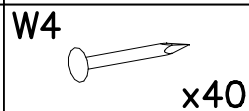
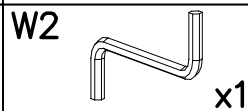
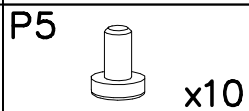
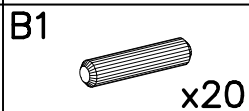
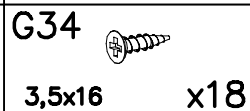
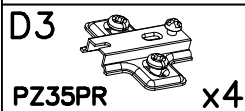
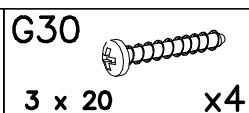
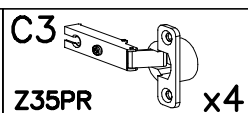
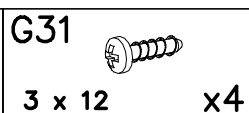
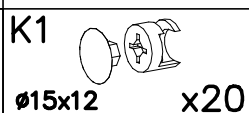
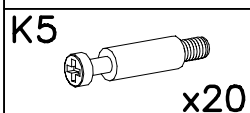
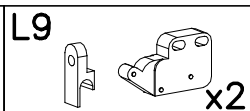
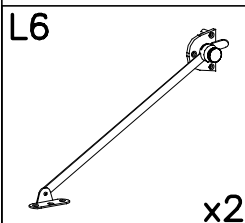
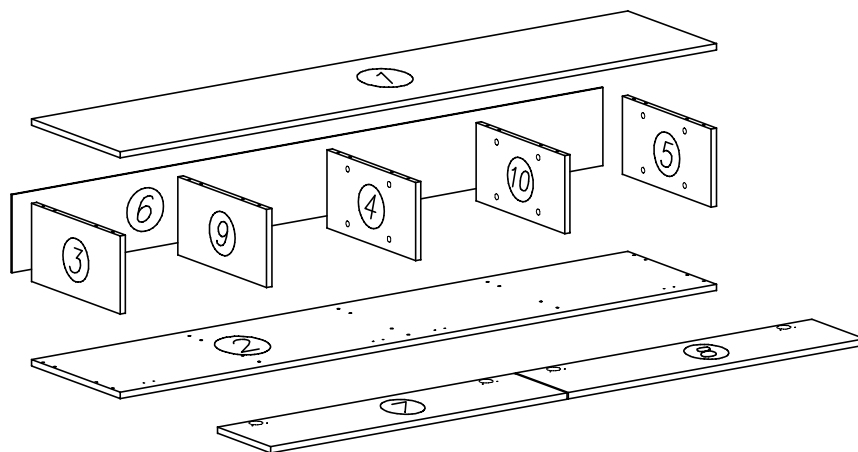

I

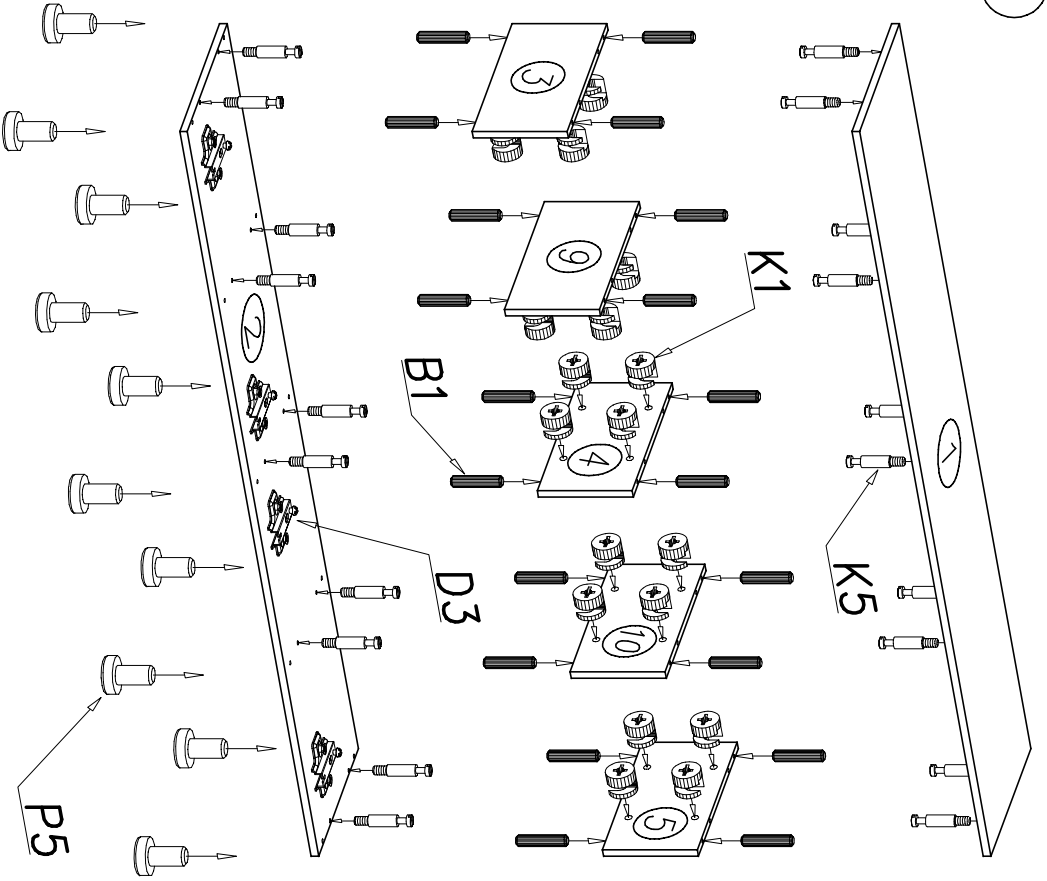

II

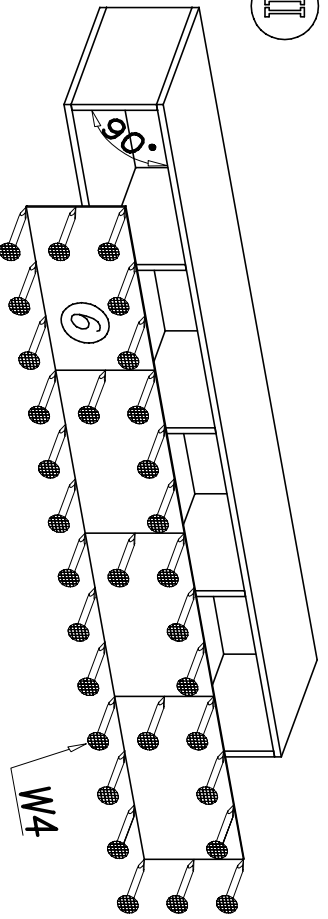

III

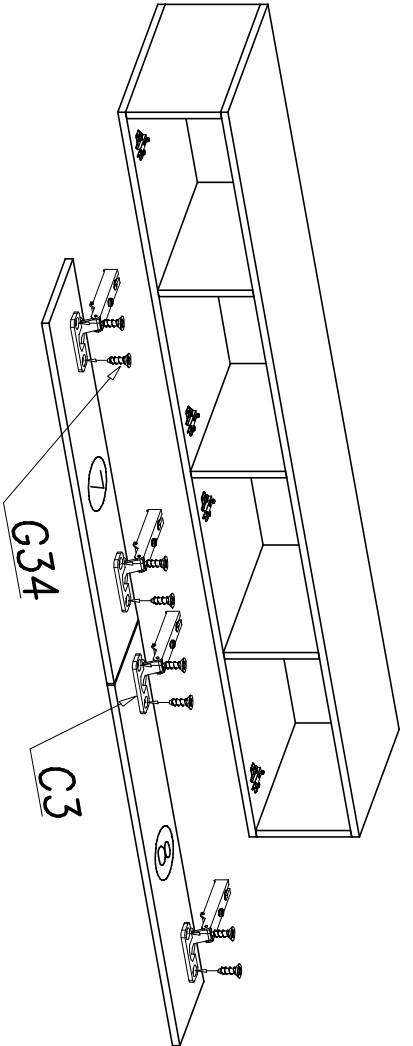

IV

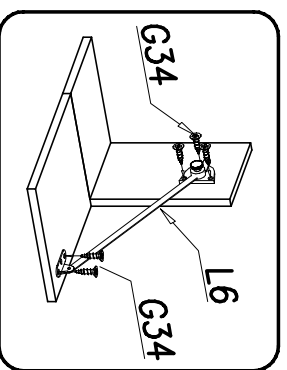
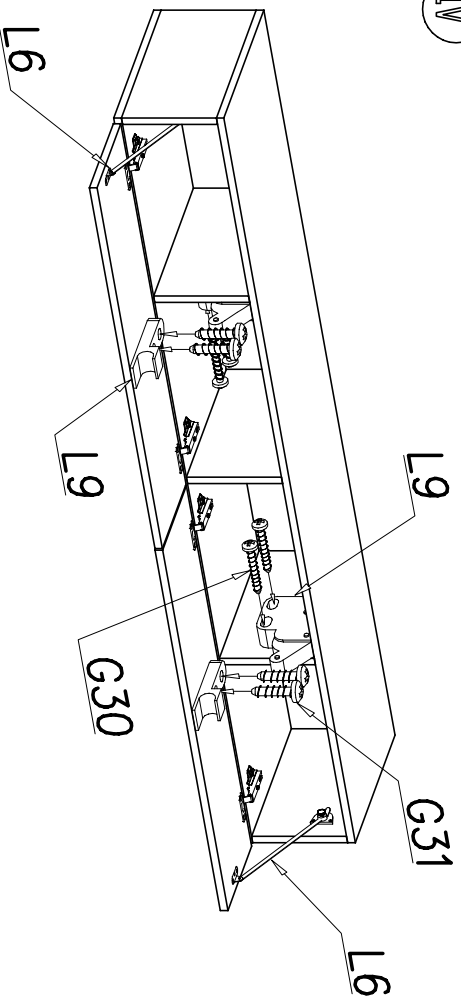

PRZED ROZPOCZĘCIEM MONTAŻU ZAPOZNAĆ SIĘ Z INSTRUKCJĄ

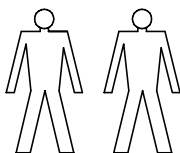

Narzędzia niezbędne do montażu (nie dostarczane przez producenta)

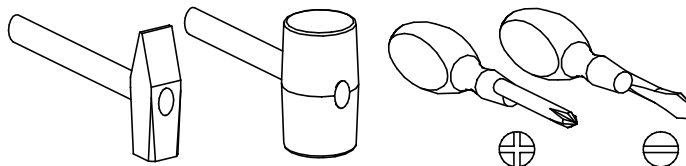

GOYA

Szafka wisząca

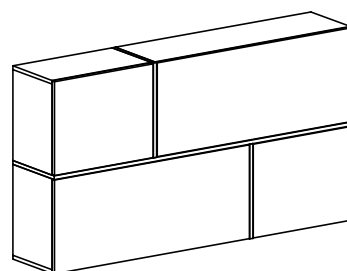
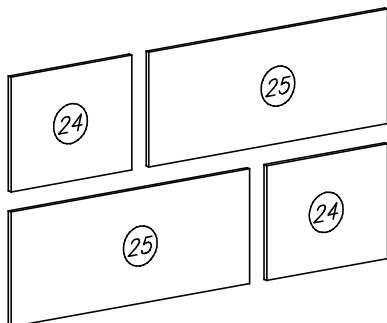
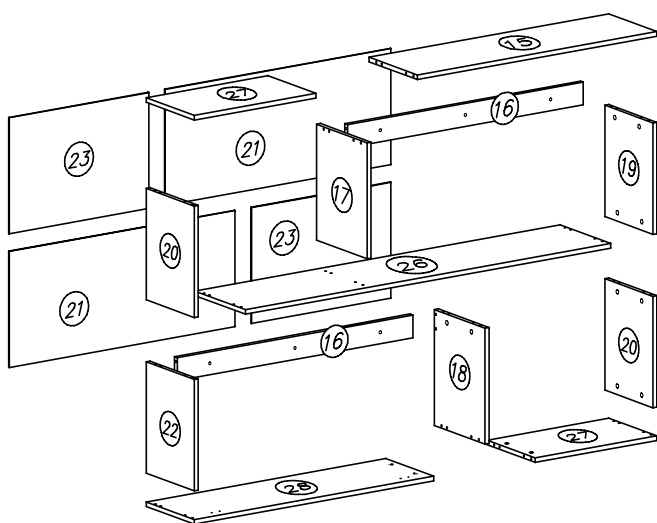
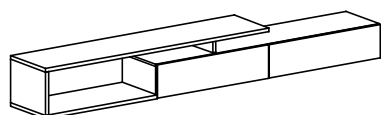
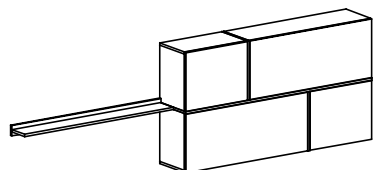

Nr	Nazwa elementu	Dł [mm]	Szer [mm]	Gr [mm]	Ilość	Kod	Paczka
15	wieniec duży górny	984	282	16	1		
16	listwa	967	80	16	2		
17	przegroda górna	404	304	16	1		
18	przegroda dolna	404	304	16	1		
19	bok prawy górny	388	282	16	1		
20	bok	388	282	16	2		
21	HDF tył	986	405	2,5	2		
22	bok lewy dolny	388	282	16	1		
23	HDF tył	502	405	2,5	2		
24	drzwi	495	399	16	2		
25	klapa duża	979	399	16	2		
26	wieniec środkowy	1500	304	16	1		
27	wieniec mały	500	282	16	2		
28	wieniec duży dolny	984	282	16	1		

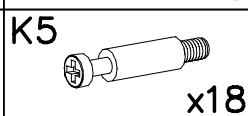
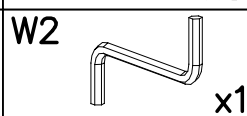
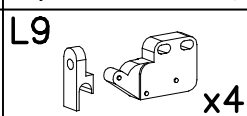
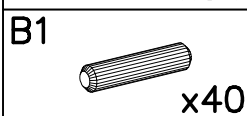
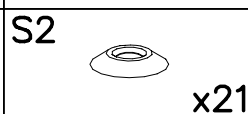
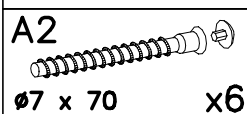
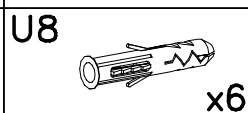
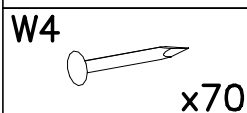
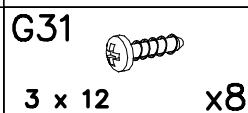
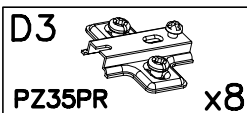
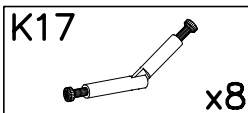
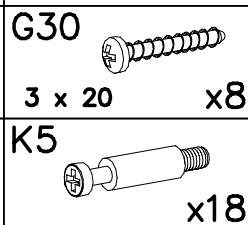
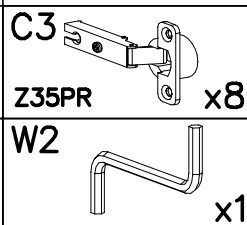
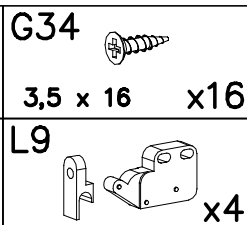
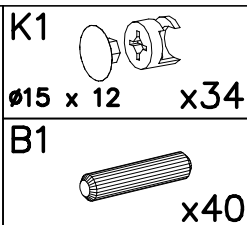
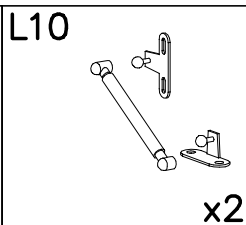
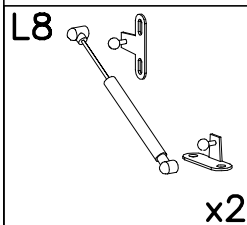

I

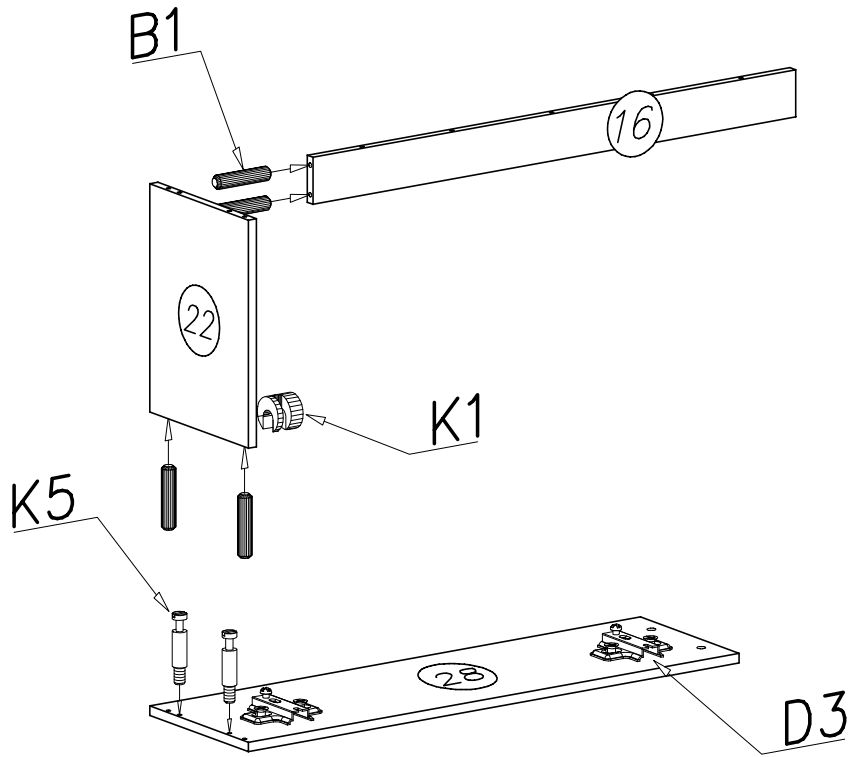

II

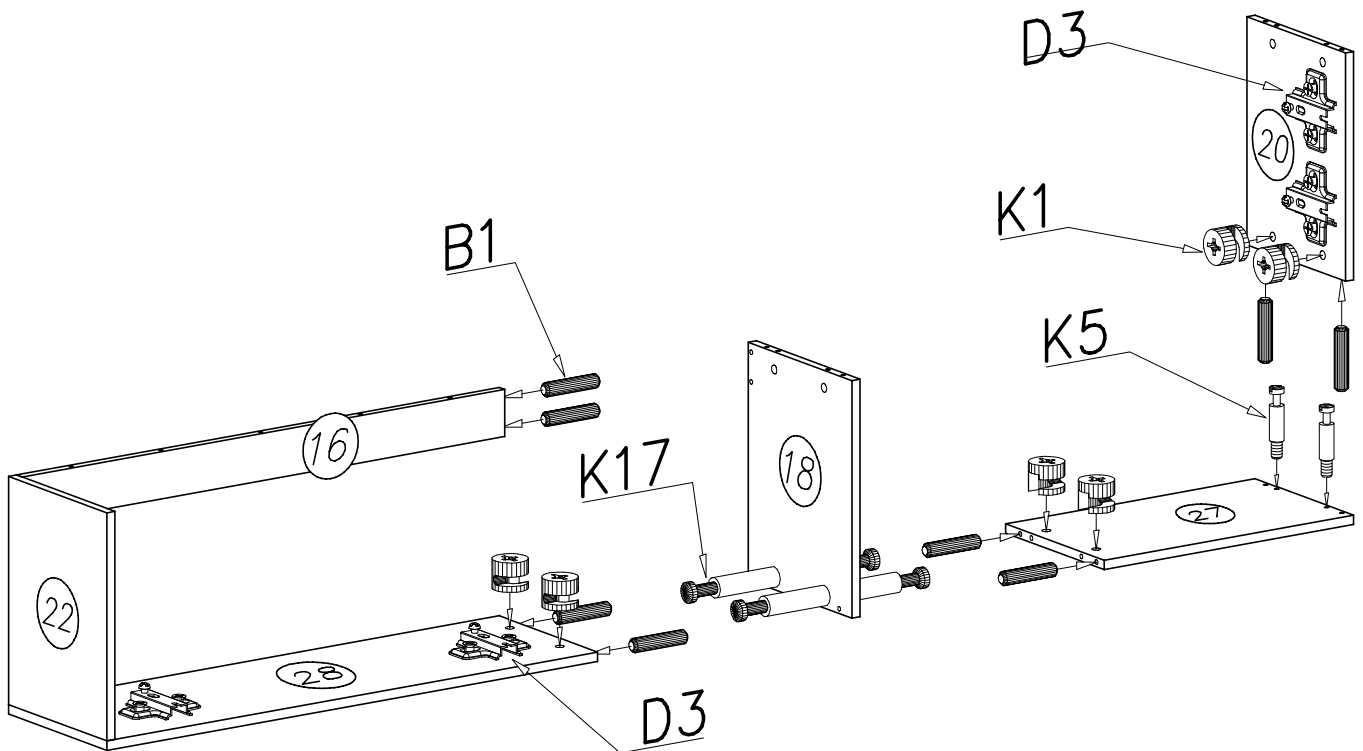

III

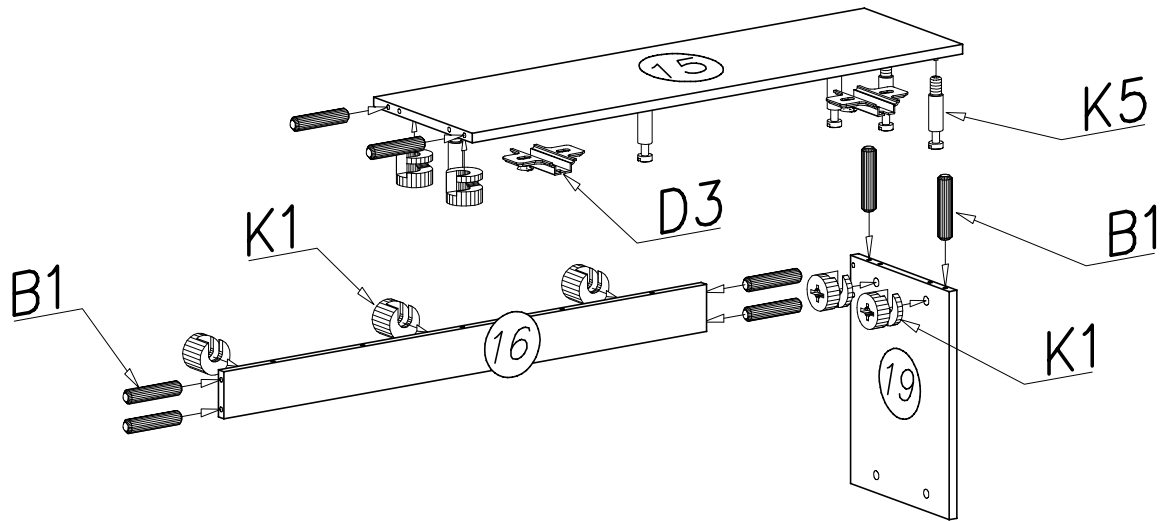

IV

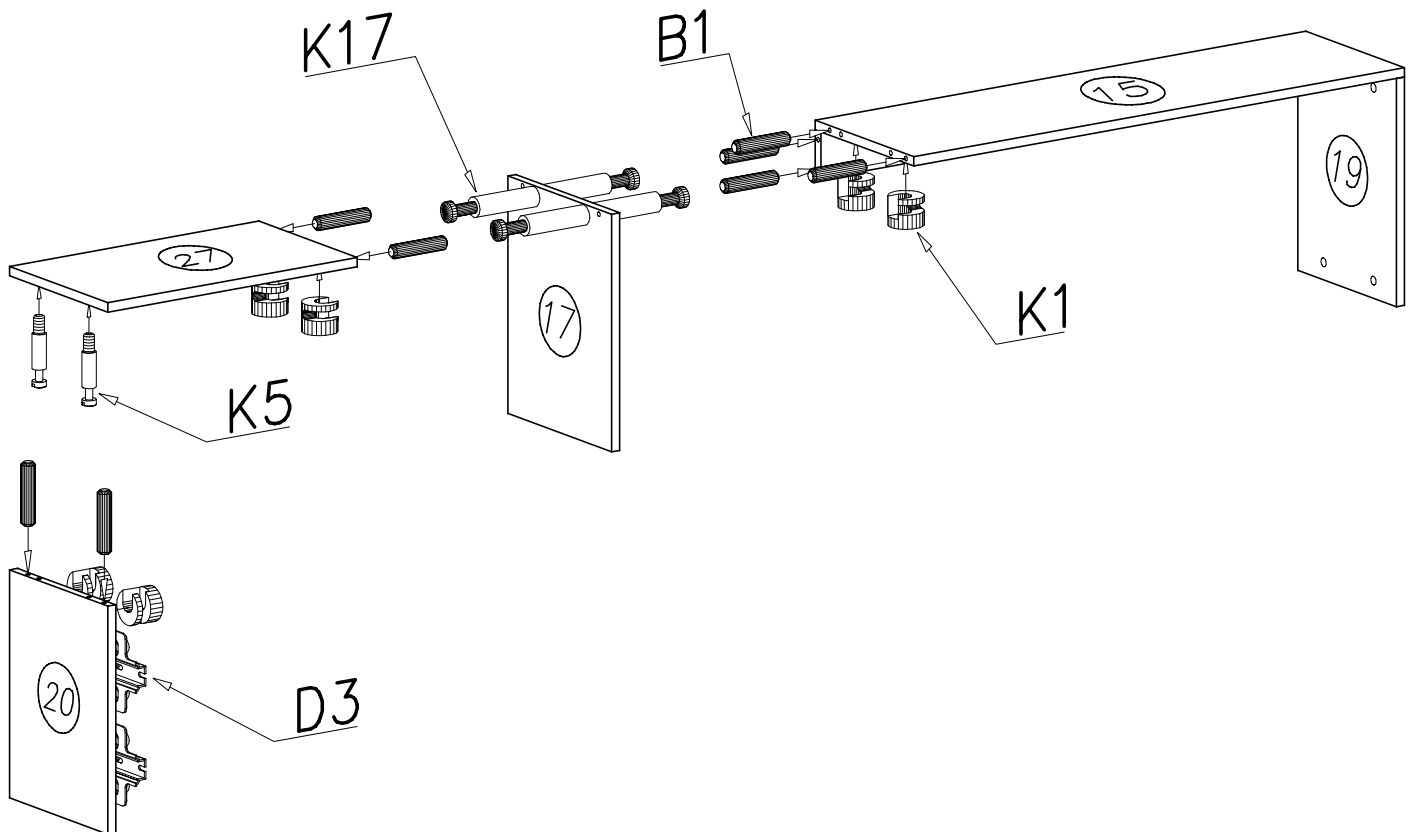

V

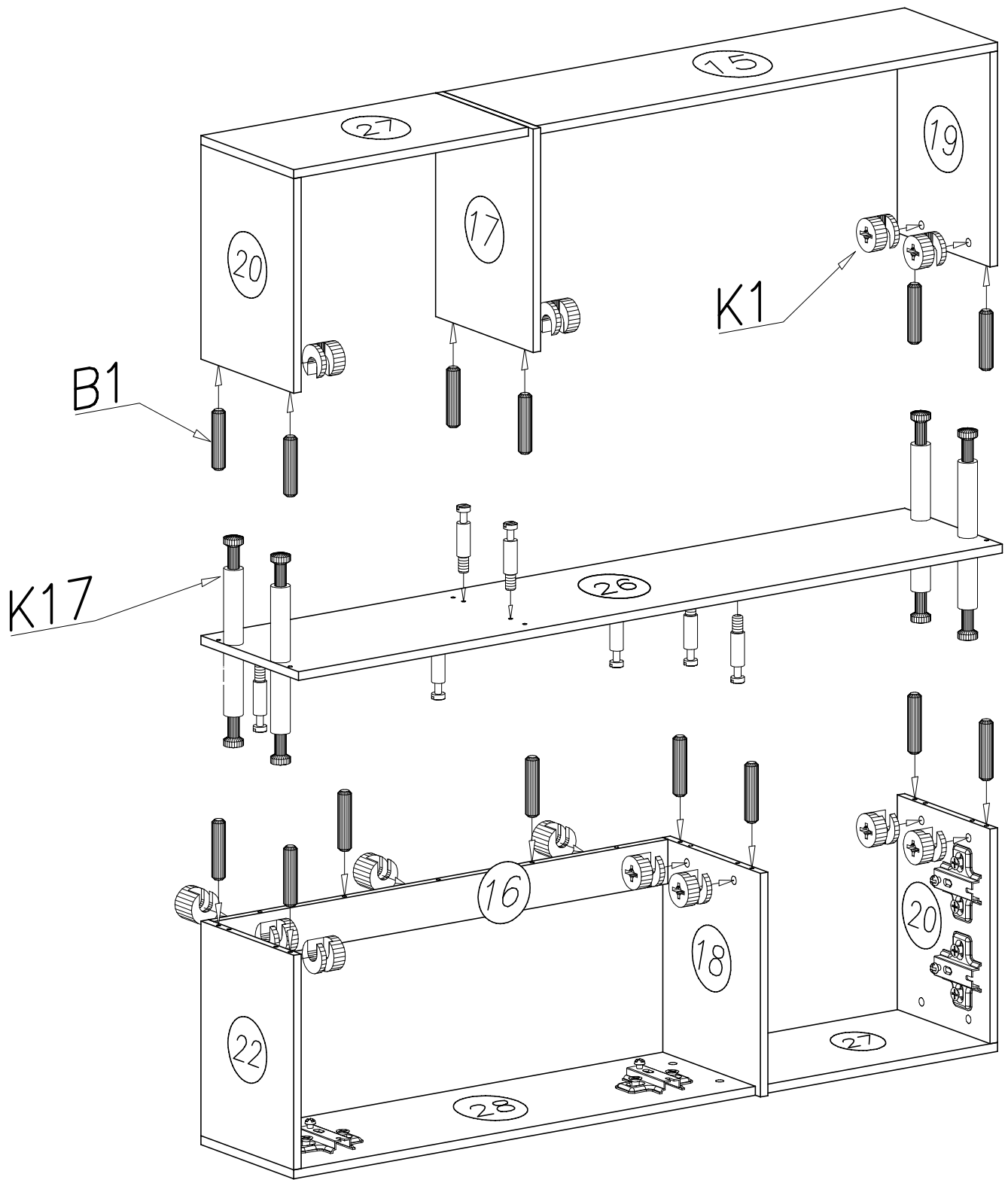

VI

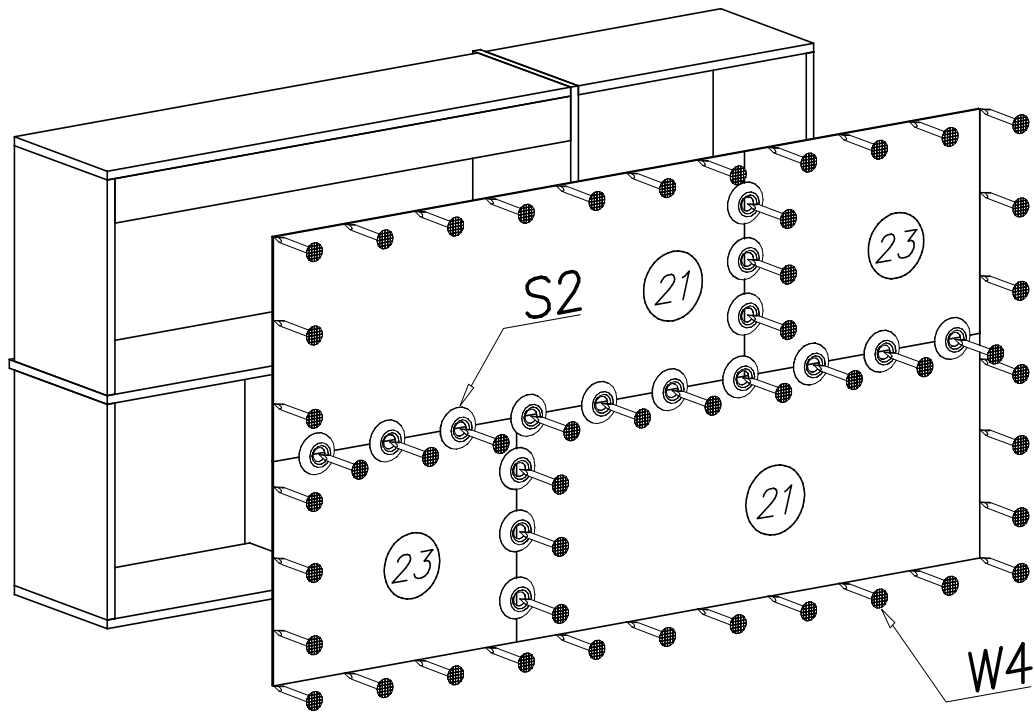

VII

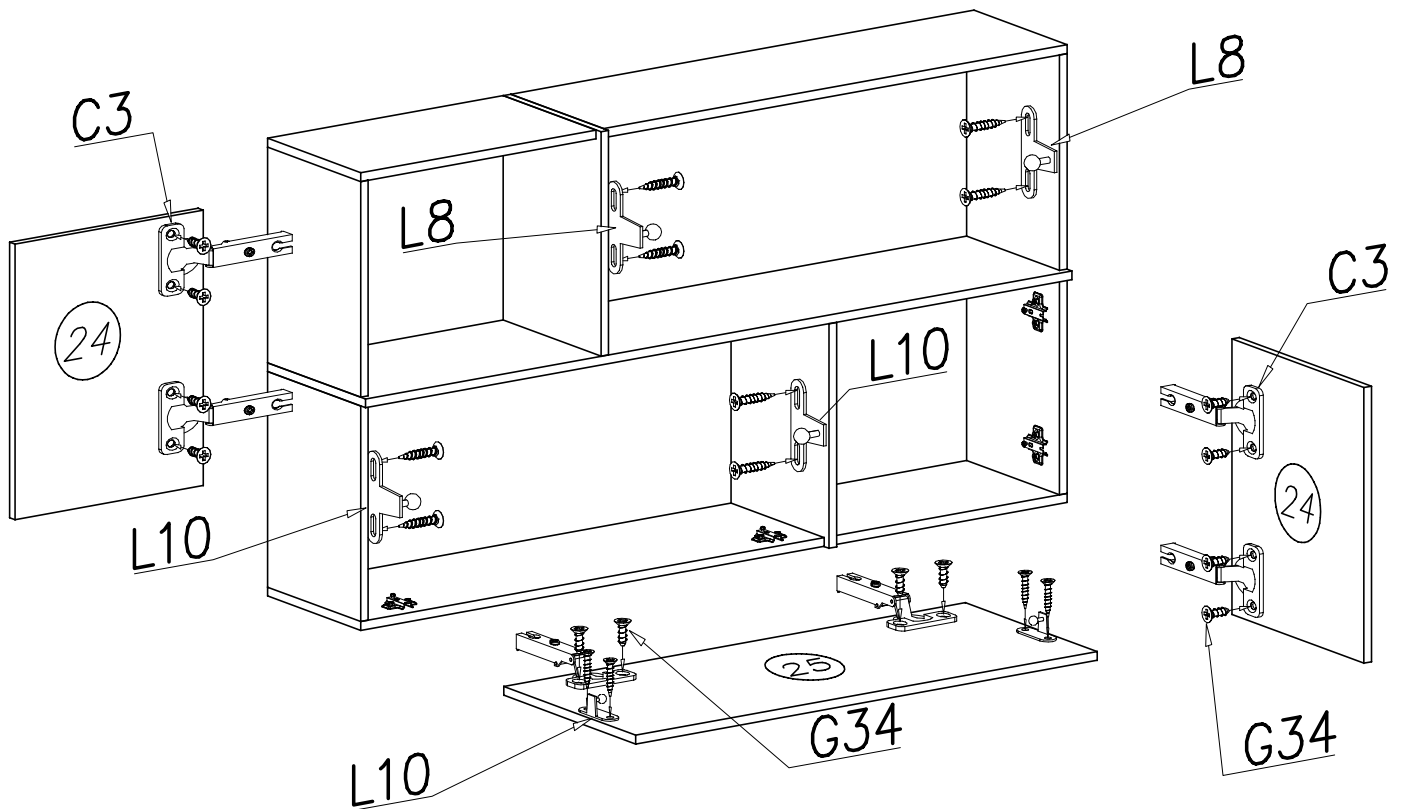
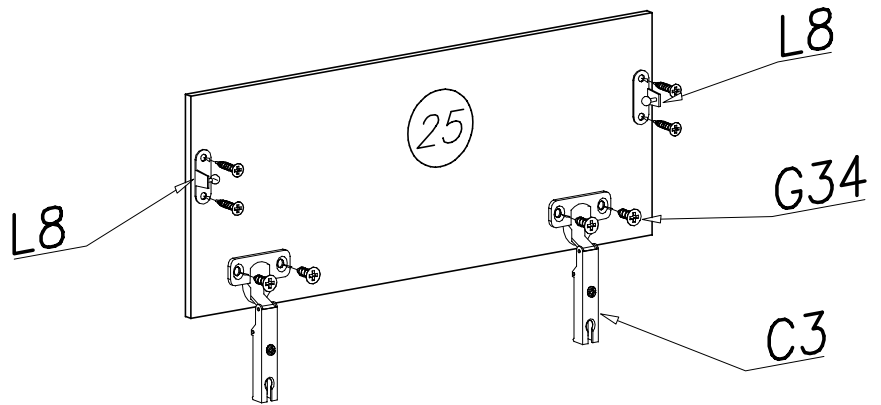

VIII

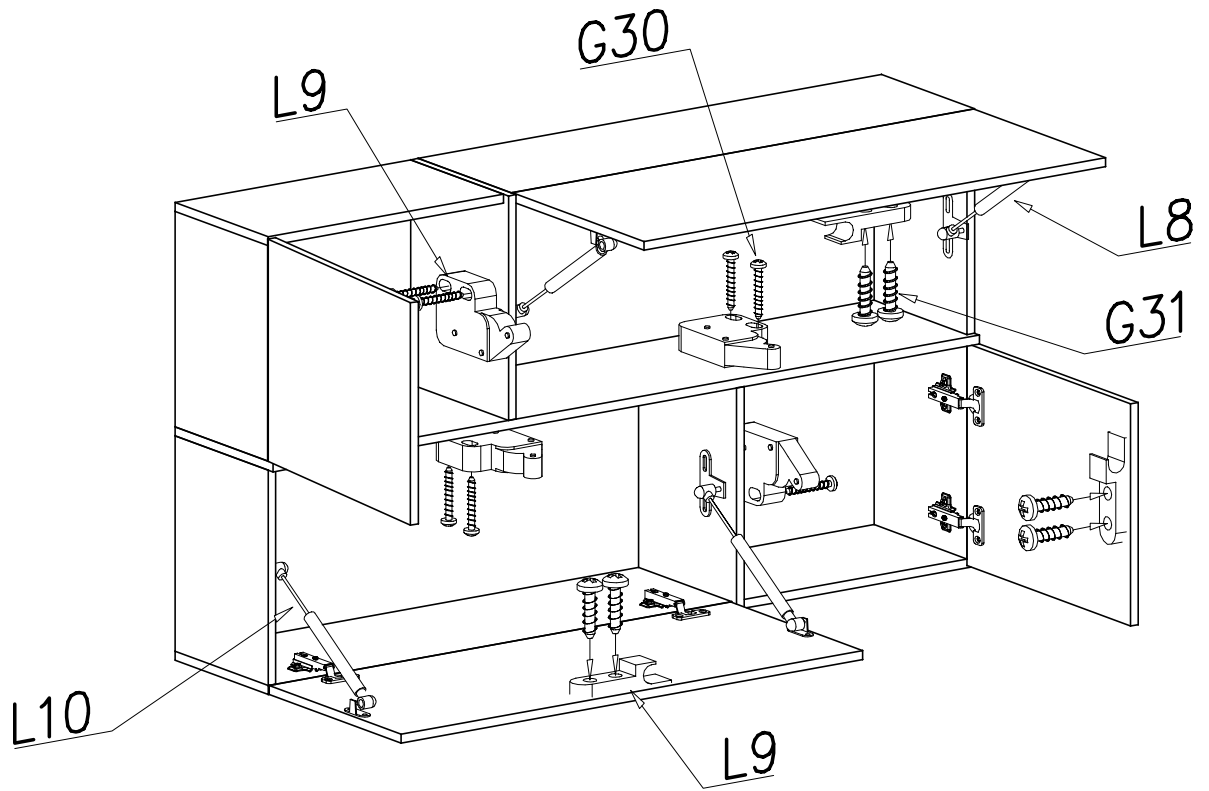

IX

