





1

T6  x28

M1  x16

T1  x16

B1  8x28 x18

K1  7x50 x4

C1  2 x2

P16  4,2x12 x22

M6  x22

C2  Ø15 x16

C3  Ø10 x6

W1  x16

L1  x1

2

F7  x2

S3  3,0x13 x2

3

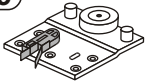
E9  x1

E1  6,3x11 x5

E11  x1

4

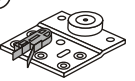
E5  x1

E1  6,3x11 x5

5

E7  x2

E1  6,3x11 x10

6

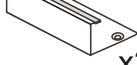
E3  x2

E1  6,3x11 x4

7

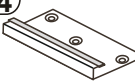
E4  x2

E1  6,3x11 x4

8

L4  x2

S4  3,5x13 x7

S3  3,0x13 x120

S5  x2

9

J11  x2



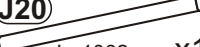

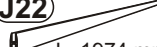

P13  3,5x13 mm x4

J20  L=1062 mm X1

J22  L=1974 mm X1



1

W1  x16	T6  x24	F7  x2	B1  8x28 x8
T1  x8	S3  3,0x13 x2	M1  x8	

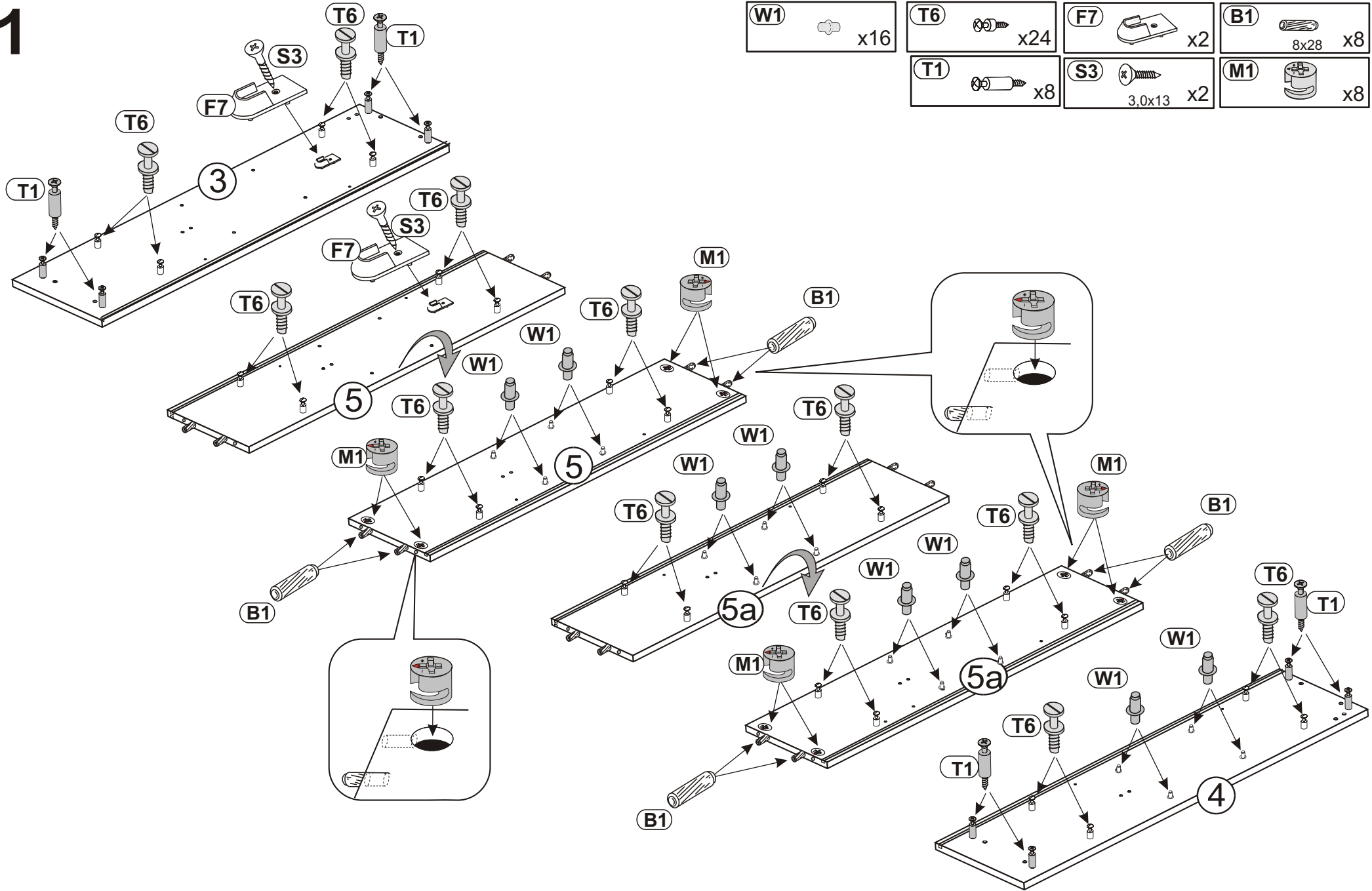

2

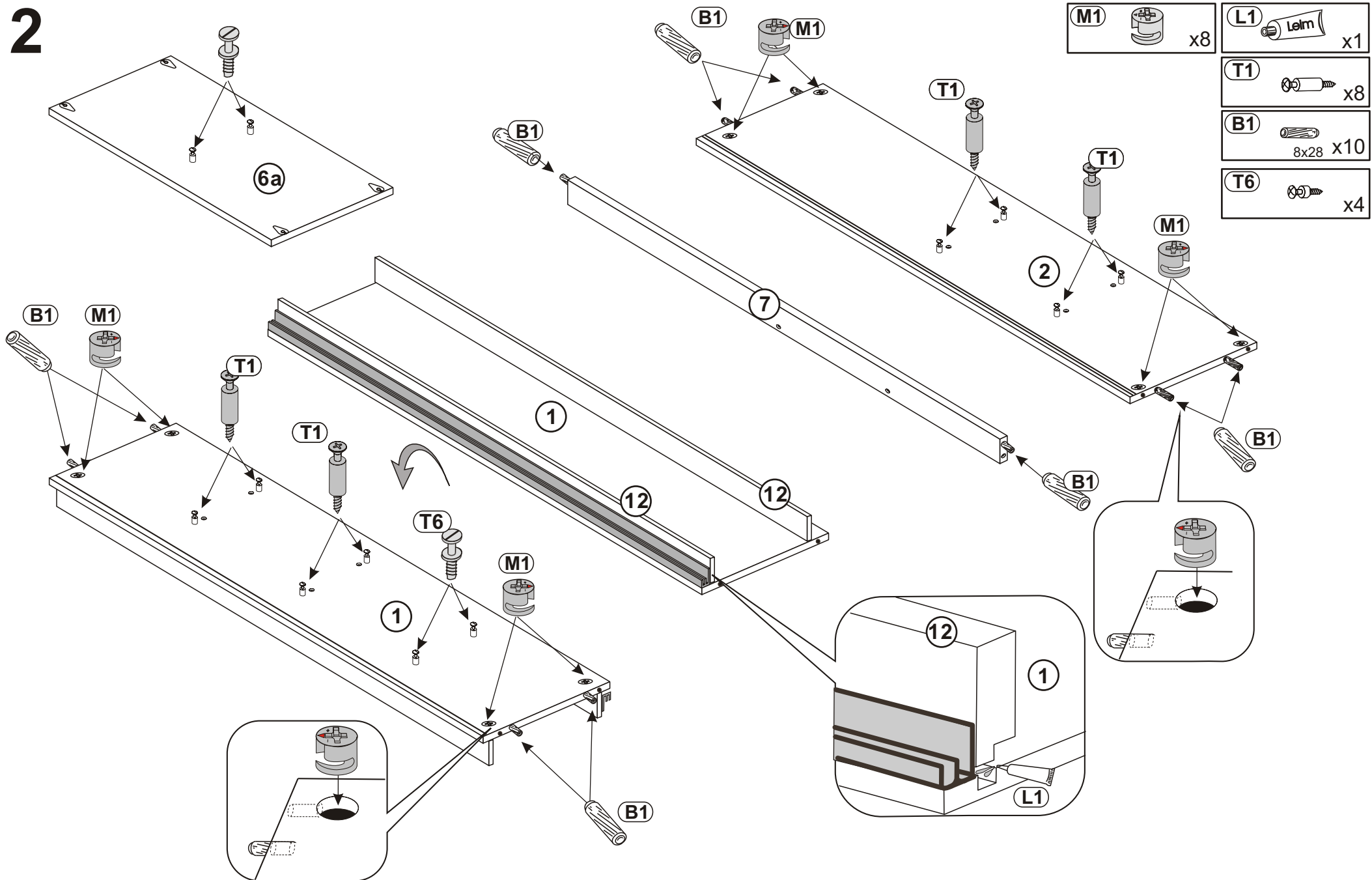

3

- K1** 7x50 x2
- C1** 2 x1
- M6** x8
- J22** L=1974 mm X1
- P16** 4,2x12 x8

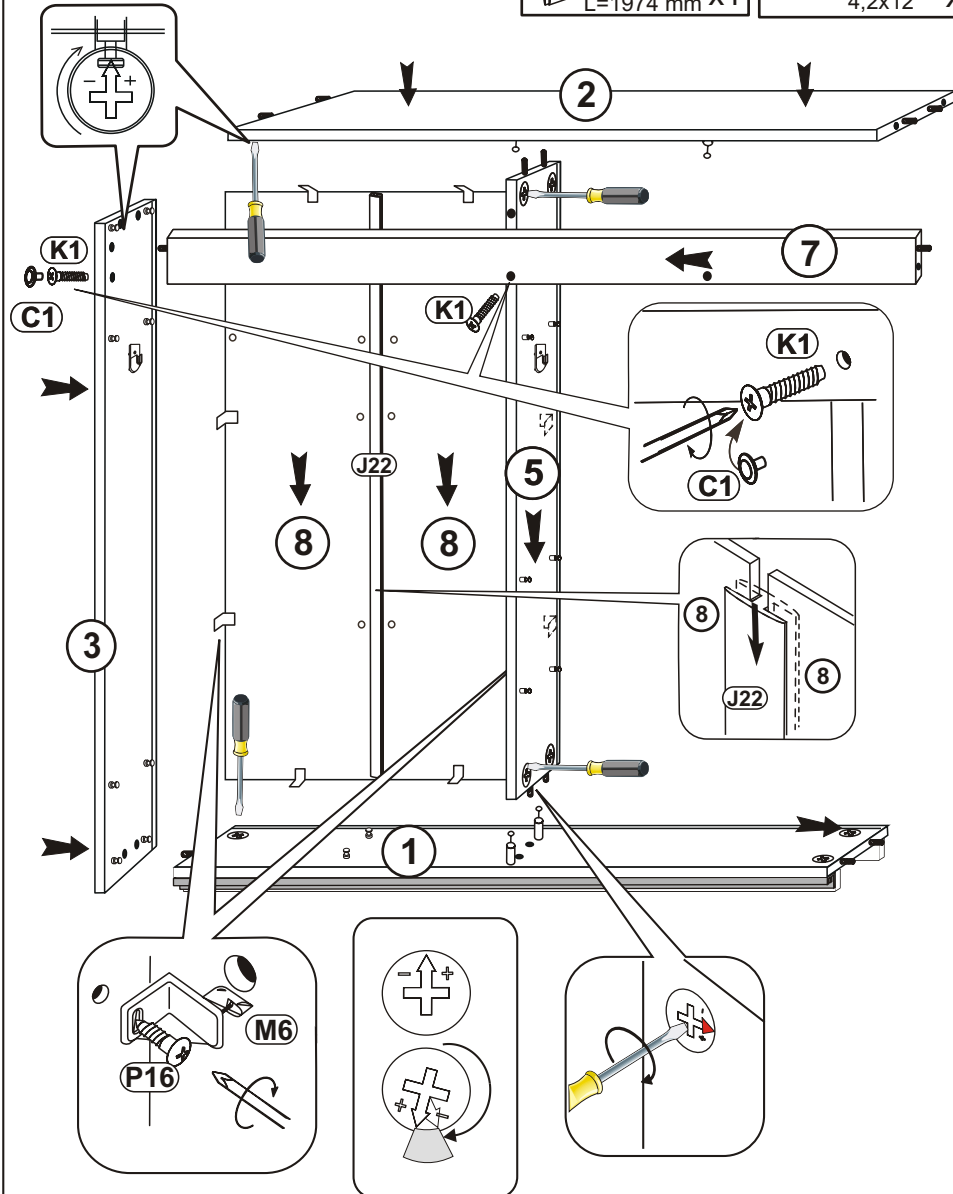

4

- K1** 7x50 x2
- P16** 4,2x12 x12
- C1** 2 x1
- M6** x12

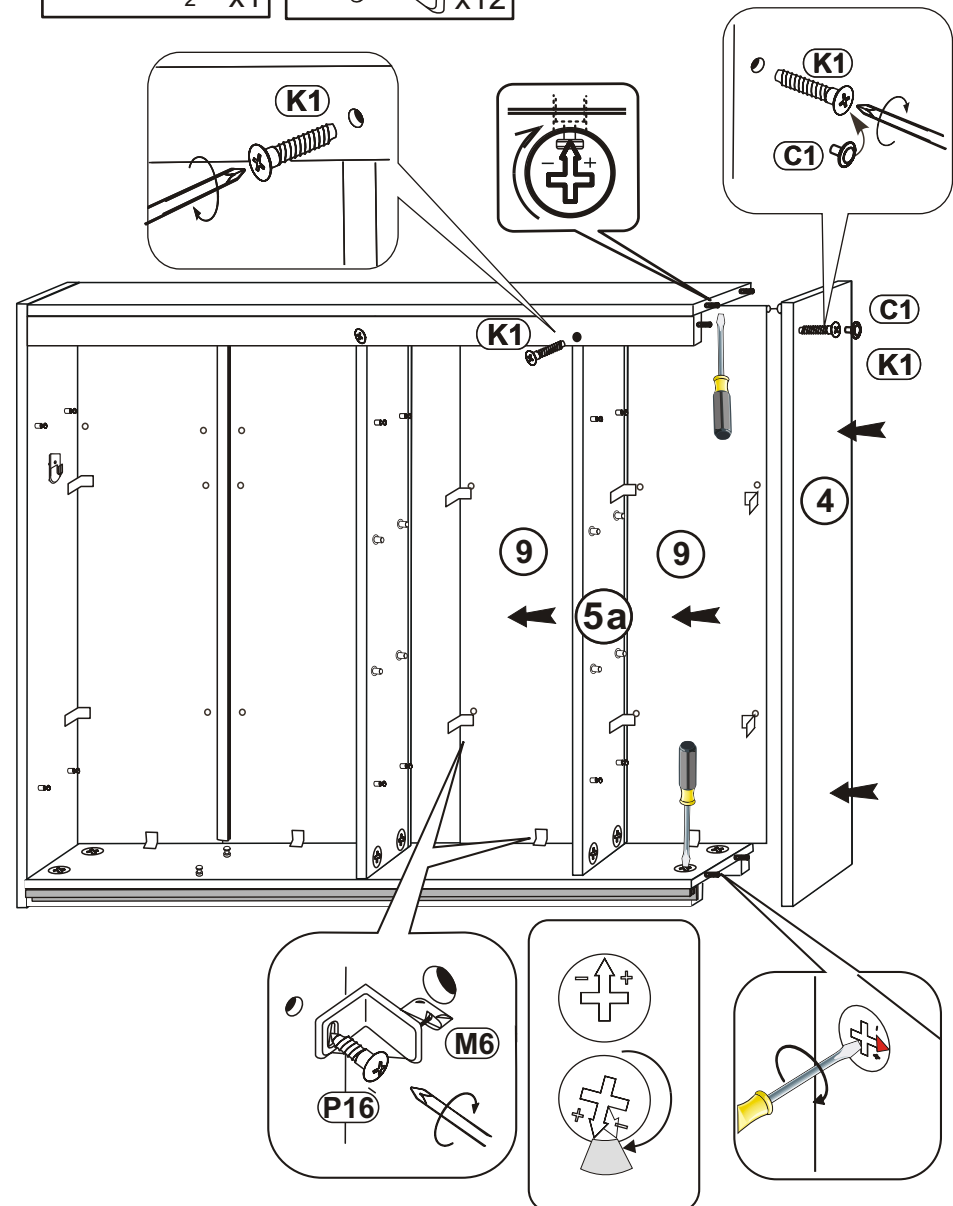

5

P16 4,2x12 x2

M6 x2

J20 L=1062 mm X1

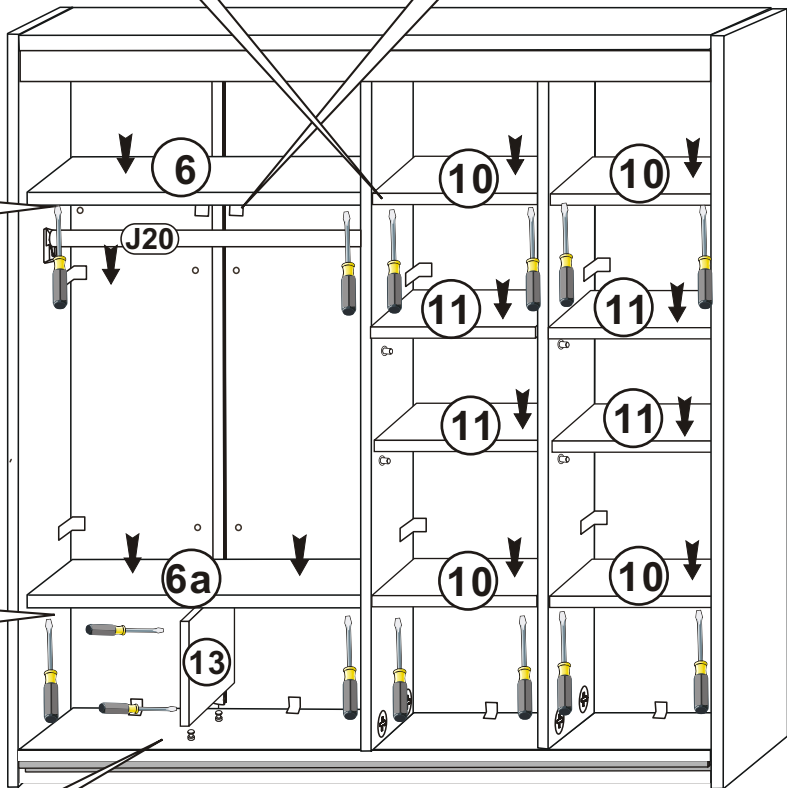
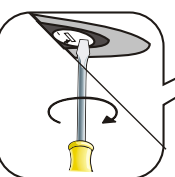
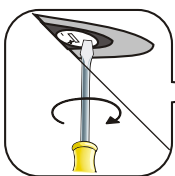
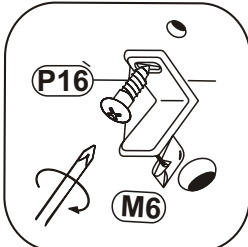

6

S4 3,5x13 x7

C2 Ø15 x16

C3 Ø10 x6

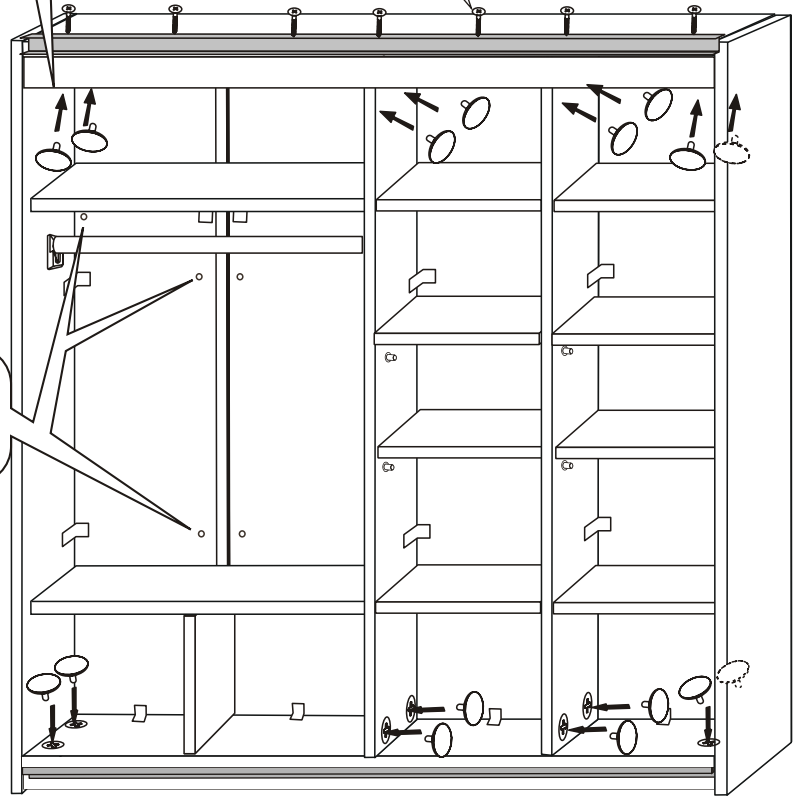
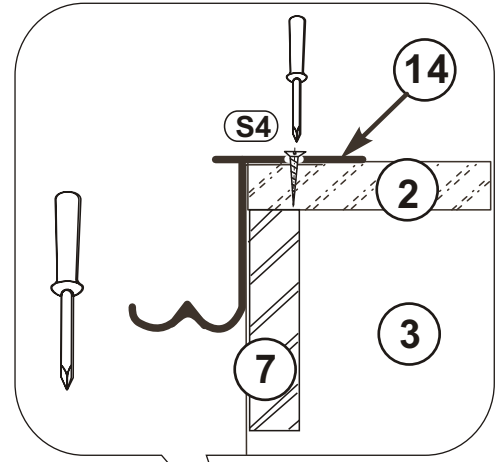
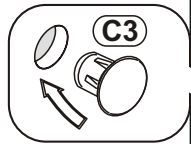
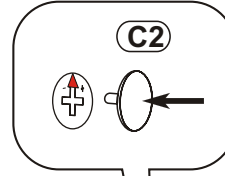

7

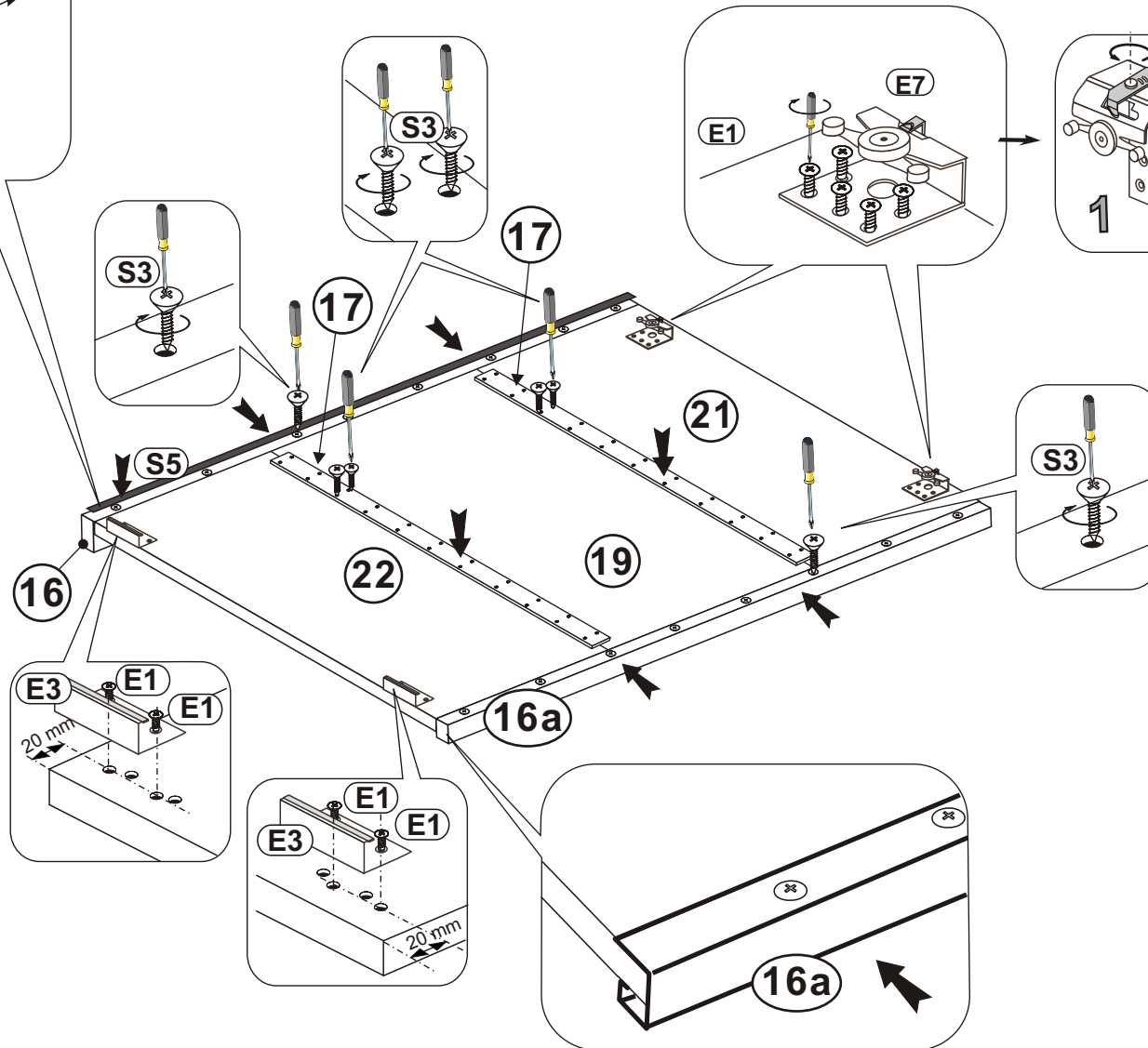
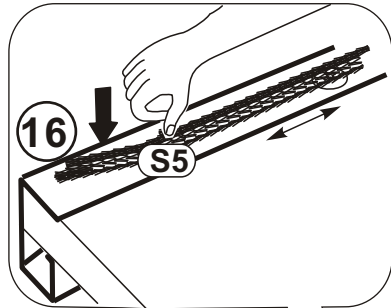
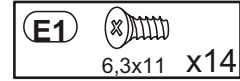
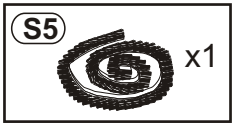
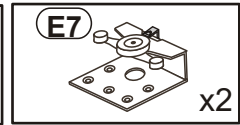
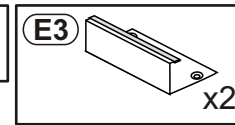
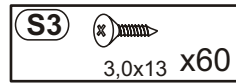

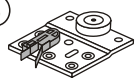

8

S3  3,0x13 x60

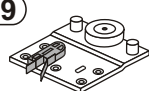
E5  x1

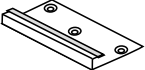
E9  x1

E4  x2

E1  6,3x11 x14

S5  x1

E11  x1

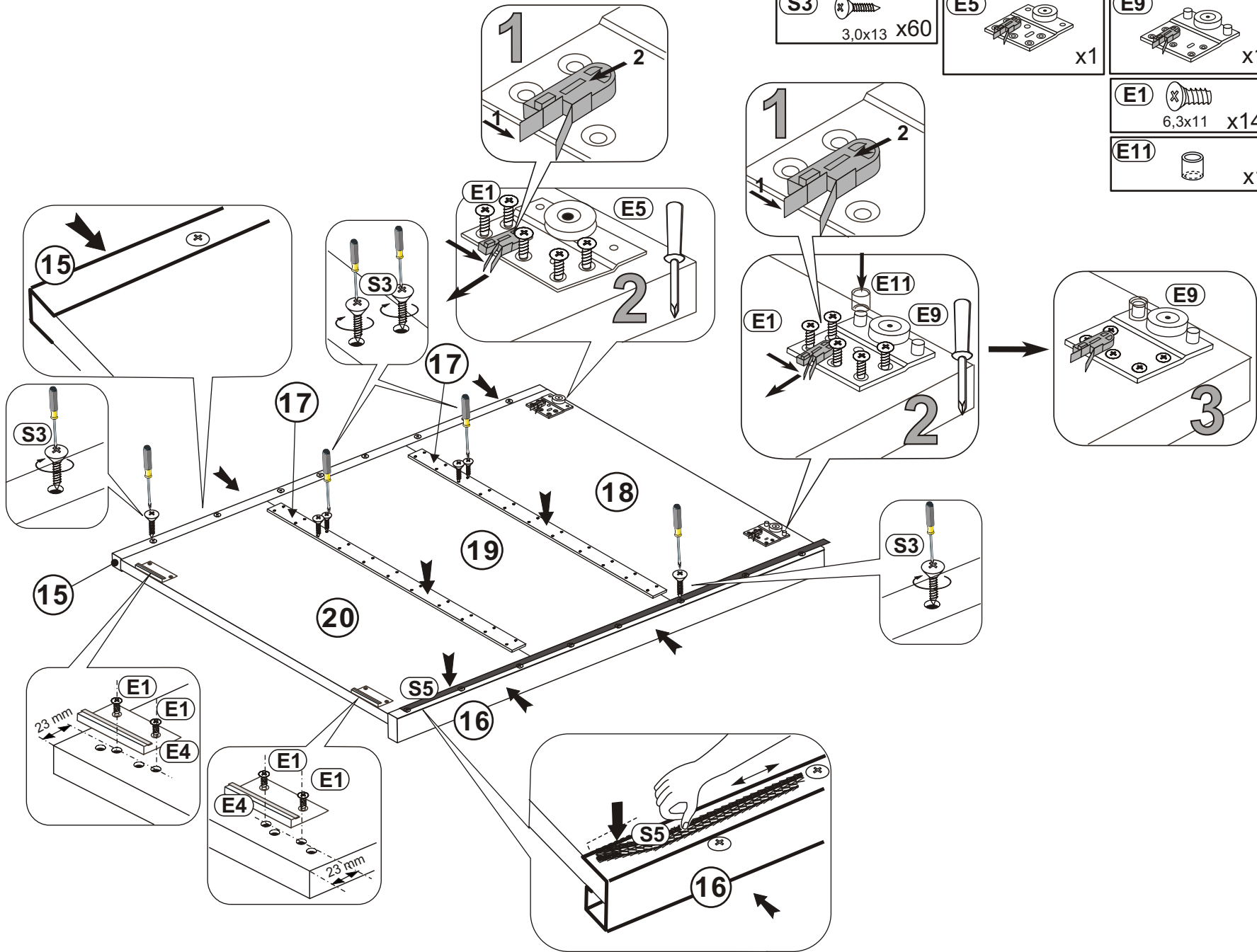

9

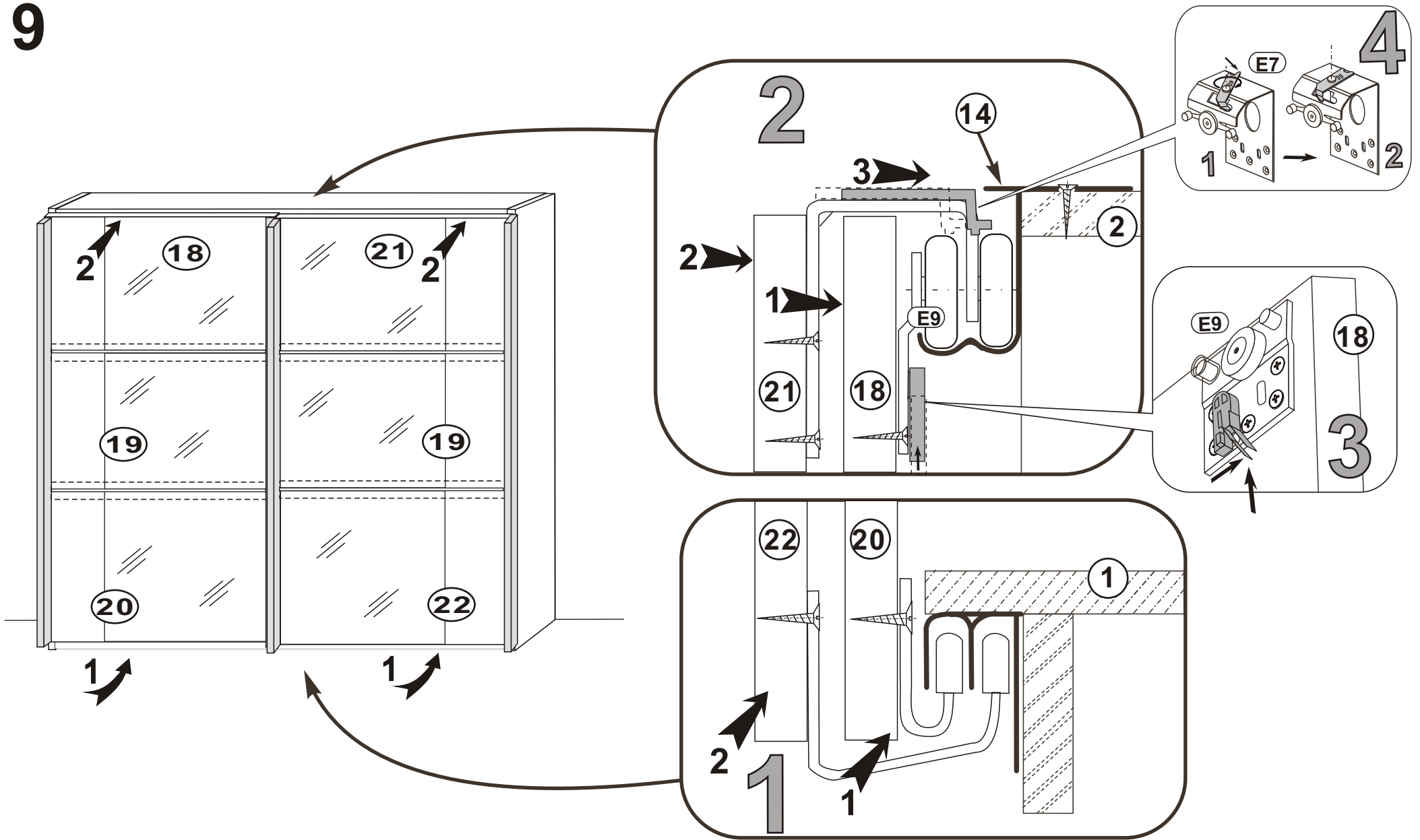

10

