









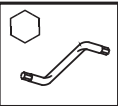
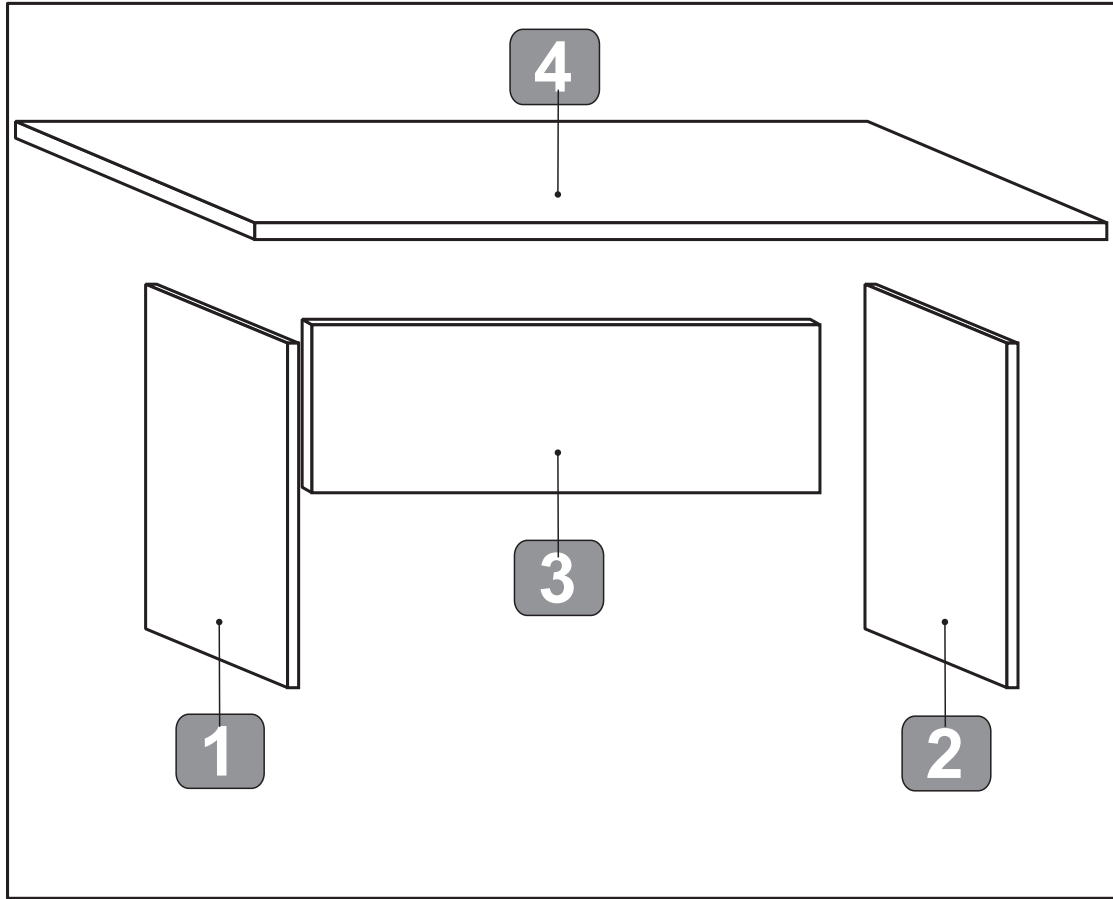

## MAG EURO 23

**03 -- 50**

 <b>40 MIN</b>	 <b>x2</b>			
				

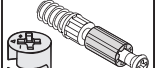

*Avant de commencer, se reporter aux conseils de montage en annexe*  
**Before starting, refer to the assembling advice in annex**  
*Avanti di cominciare, riportate agli consigli di montaggio*  
**Vor die montage, bitte beiliegende anweisungen folgen**  
*Antes de començar, adiar se aos conselhos de montagem em anexo*  
**Antes de empezar consulte los consejos para el montaje**  
*Przed rozpoczęciem zapoznać się załączoną instrukcją montaży*

<b>Bag</b>				<b>Bag</b>			<b>Bag</b>	
<b>2</b>	a 8	b 4	c 4	<b>3</b>	b 4	c 4	<b>4</b>	c 4

