

8002

1320x720

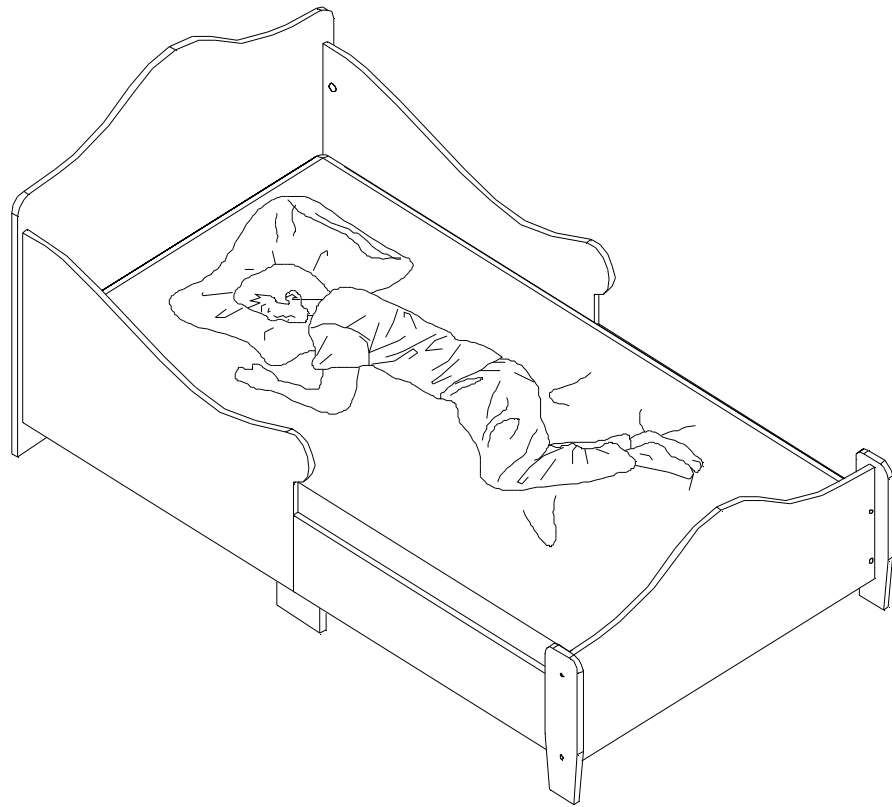

D Montageanleitung

NL Handleiding voor de montage

TR Montaj talimatı

FR Notice de montage

CS Montážní návod

HU Szerelési útmutató

GB Assembly instructions

PL Instrukcja montażu

RU Инструкция по монтажу

IT Istruzioni di montaggio

SK Návod na montáž



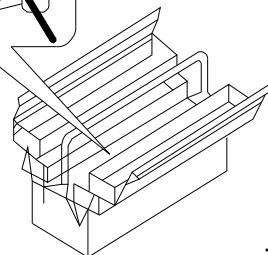
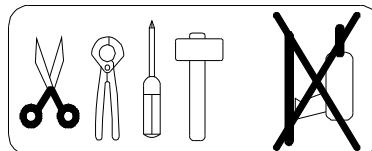
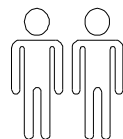



RO Instrucțiuni de montaj

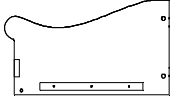
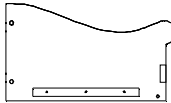
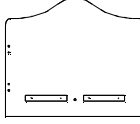

10F8
TOTAL 8 PAGE

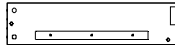
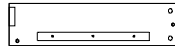
BEFORE YOU BEGIN	AVANT LE MONTAGE	VOOR DE MONTAGE
<p>Adult assembly required</p> <p>Not suitable for children under three years, due to sharp points and small parts</p> <p>Warning : choking hazard. Unassembled parts may be choking hazard to children 3 years and younger.</p> <p>Use the tools indicated on the assembly leaflet and follow the instructions.</p> <p>All assembly components must always be tightened properly. Check regularly and retighten if necessary.</p>	<p>assemblage uniquement par un adulte</p> <p>Ne convient pas aux enfants de moins de 3 ans, à cause de pièces pointues et coupantes</p> <p>Avertissement: Risque d'étouffement. Les pièces non assemblées peuvent provoquer un risque d'étouffement pour les enfants de 3 ans et moins.</p> <p>Utiliser les outils indiqués sur la notice de montage et suivre les instructions d'assemblage. Il convient que tous les dispositifs d'assemblage soient toujours convenablement serrés et régulièrement vérifiés, ainsi que resserrés si nécessaire.</p>	<p>montage mag alleen door volwassenen uitgevoerd worden niet geschikt voor kinderen onder d 3 jaar vanwege scherpe punten en kleine onderdelen</p> <p>Waarschuwing: Gevaar voor verstikking. Losse onderdelen kunnen verstikking veroorzaken bij kinderen onder 3 jaar.</p> <p>Gebruik het op de montagehandleiding aangegeven gereedschap en volg de assemblage instructies.</p> <p>Alle bevestigingsmiddelen van de de assemblage moeten behoorlijk zijn vastgedraaid, regelmatig worden gecontroleerd en zonodig opnieuw worden aangehaald.</p>
<p>USE AND MAINTAINANCE</p> <p>Clean the surface using a slightly damp cloth and mild washing liquid if necessary.</p> <p>Do not use any cleaning product containing alcohol or ammonia. These will dull the shiny surface of the product. Furniture polish will also work to clean and dust off the surface.</p> <p>The following applies in general: Please don't use the following detergents or cleaning agents at all :</p> <ul style="list-style-type: none"> ⌘ microfibre cloths or dirt erasers they often contain fine abrasive particles which can cause scratches on the surfaces ⌘ aggressive chemical substances as well as abrasive cleaning agents or solvents . They may damage the surfaces too. ⌘ scouring powder, steel wool or scouring pads. ⌘ vacuum cleaners. The nozzles and brushes can cause scratches on the surfaces. ⌘ steam cleaners. The surfaces may be damaged or separated from the ground due to the high pressure and heat of the water vapour. 	<p>UTILISATION ET ENTRETIEN</p> <p>Nettoyer la surface à l'aide d'un chiffon légèrement humide et de liquide vaisselle doux si nécessaire. Ne pas utiliser de produit de nettoyage contenant de l'alcool ou de l'ammoniaque. Ces produits terniront la surface brillante du produit. Un produit de polissage des meubles peut être utilisé pour nettoyer et dépolir la surface.</p> <p>En règle générale: Veuillez n'utiliser en aucun cas les détergents suivants:</p> <ul style="list-style-type: none"> ⌘ chiffons à microfibres ou gomme à saleté. Ils contiennent souvent de fine particules abrasives qui peuvent rayer les surfaces. ⌘ substances chimiques agressives ainsi que des détergents abrasifs. Ceux-ci peuvent également endommager les surfaces. ⌘ poudre à récurer, paille de fer ou éponge grattant. ⌘ aspirateur. les buses et les brosses peuvent rayer la surface. ⌘ nettoyeur à vapeur. De fait de la haute pression et de la chaleur avec lesquelles la vapeur d'eau sort sur la surface, elles peuvent être endommagées et même décoller la base. 	<p>GEBRUIK EN ONDERHOUD</p> <p>Maak het oppervlak zonodig schoon met een vochtige doek en een zacht vloeibaar afwasmiddel. Gebruik geen schoonmaakmiddelen die alcohol of ammonia bevatten. Deze maken het glanzende oppervlak van het artikel dof. Meubelwas is ook een goed middel om vuil en stof van het oppervlak te verwijderen.</p> <p>In principe geldt: gebruik zeker niet volgende reinigings- en poetsmiddelen:</p> <ul style="list-style-type: none"> ⌘ microvezeldoeken of vuil-gommen. Deze bevatten vaak fijne slijpdeeltjes die kunnen leiden tot krassen op de oppervlakken. ⌘ scherpe chemische substanties zoals schurende poets- of oplosmiddelen. deze kunnen de oppervlakken eveneens beschadigen. ⌘ schuurpoeder, staalwol of pannensponzen. ⌘ stofzuiger. Mondstukken en borstels kunnen krassen op de oppervlakken veroorzaken. ⌘ stoomreiniger. Door de hoge druk en de hitte, kunnen de bo-venlagen worden beschadigd of zelfs loskomen van de onder-grond.

8002 Toddle Bed Assembly Instruction

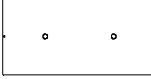
ITEM NO.	MEASUREMENT	QTY	SHAPE	CARTON NO.
①	700 X 370 X 27	X1		1-1
②	700 X 370 X 27	x1		1-1
③	770 X 600 X 27	x1		1-1
④	745 X 320 X 27	x1		1-1
⑤	660 X 150 X 27	x1		1-1
⑥	660 X 150 X 27	x1		1-1
⑦	690 X 108 X 15	x1		1-1
⑧	652 X 108 X 15	x2		1-1
⑨	280 X 80 X 12	x2		1-1
⑩	108 X 108 X 15	x2		1-1
⑪	717 X 329 X 12	x4		1-1 SLAT BASE

1320x720

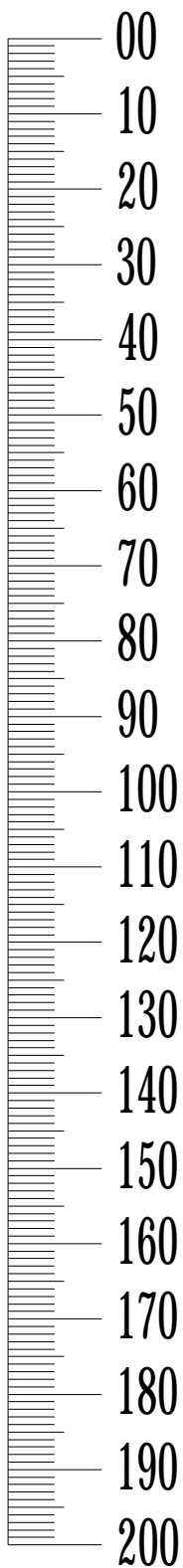



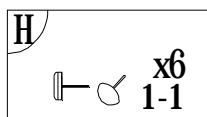
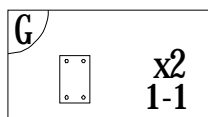
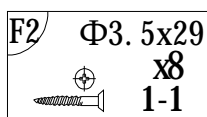
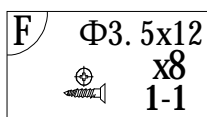
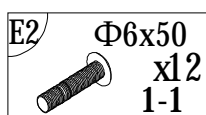
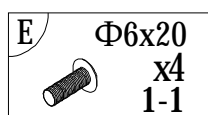
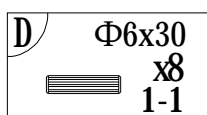
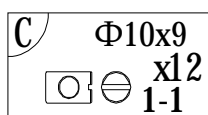
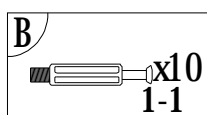
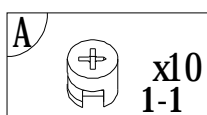
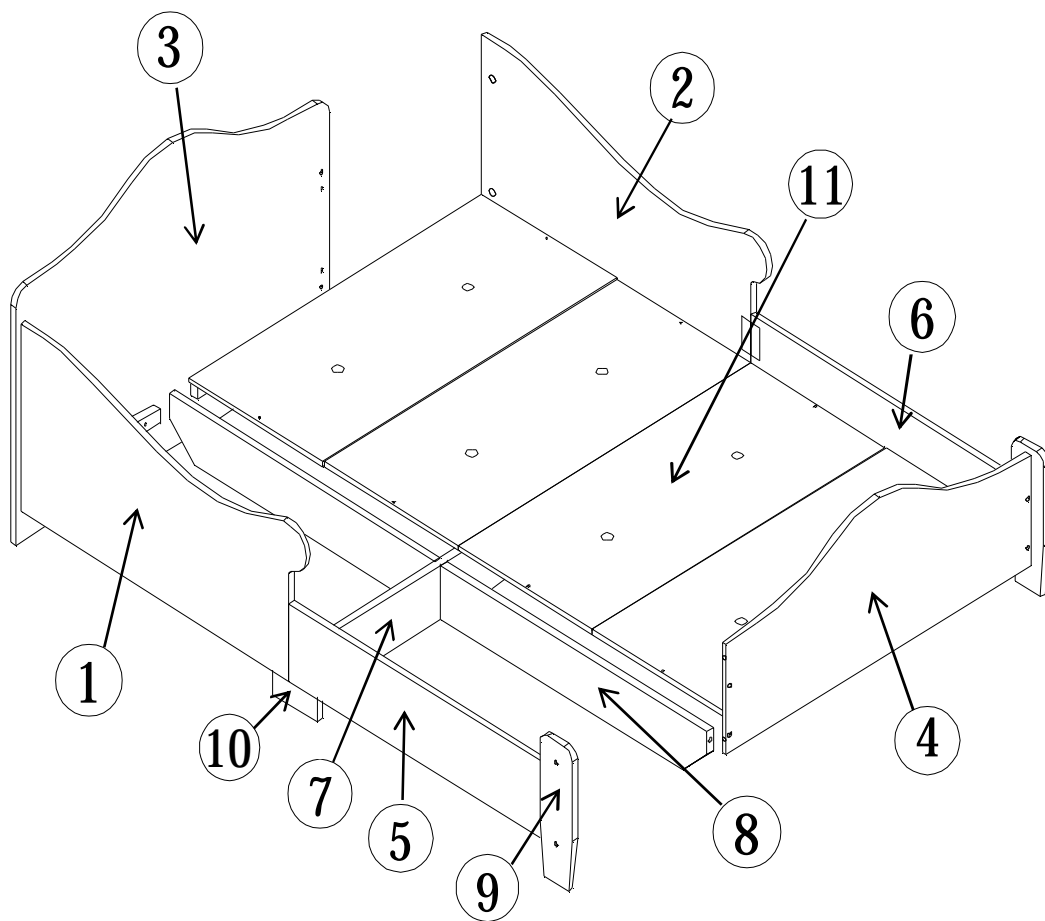

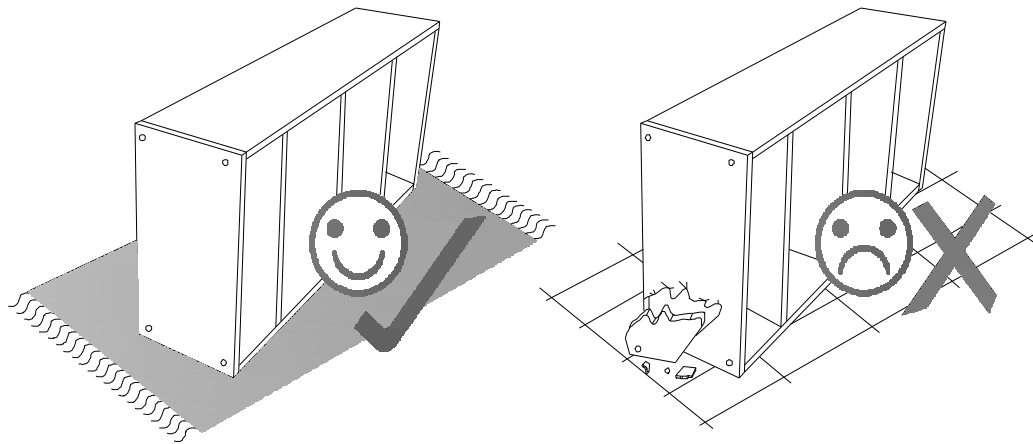
Service • Asistenza • Dienstverlening • Serwis Servis • Szerviz • Сервисная служба	
Name • Nom • Nome • Naam • Nazwa • Jméno • Názov • Név • Denumire • Isim • Название	
Nr. • No. • N° • Номер • Číslo • Sz	
Тур • Type • Típus • Tipo • Трo • Тип	





1

B  x6	C $\Phi 10 \times 9$  x12	D $\Phi 6 \times 30$  x8	H  x6
--	--	---	---

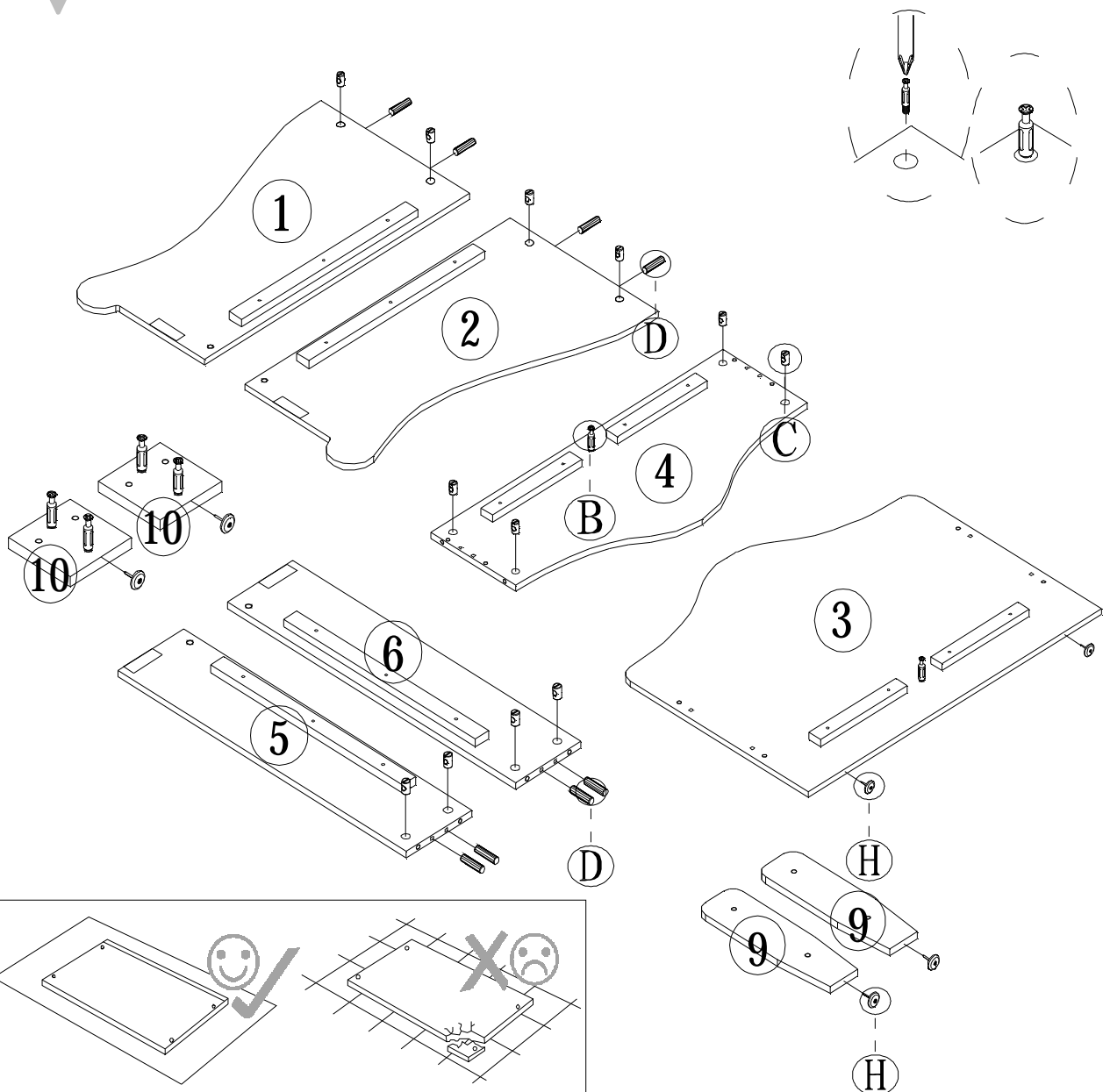

2

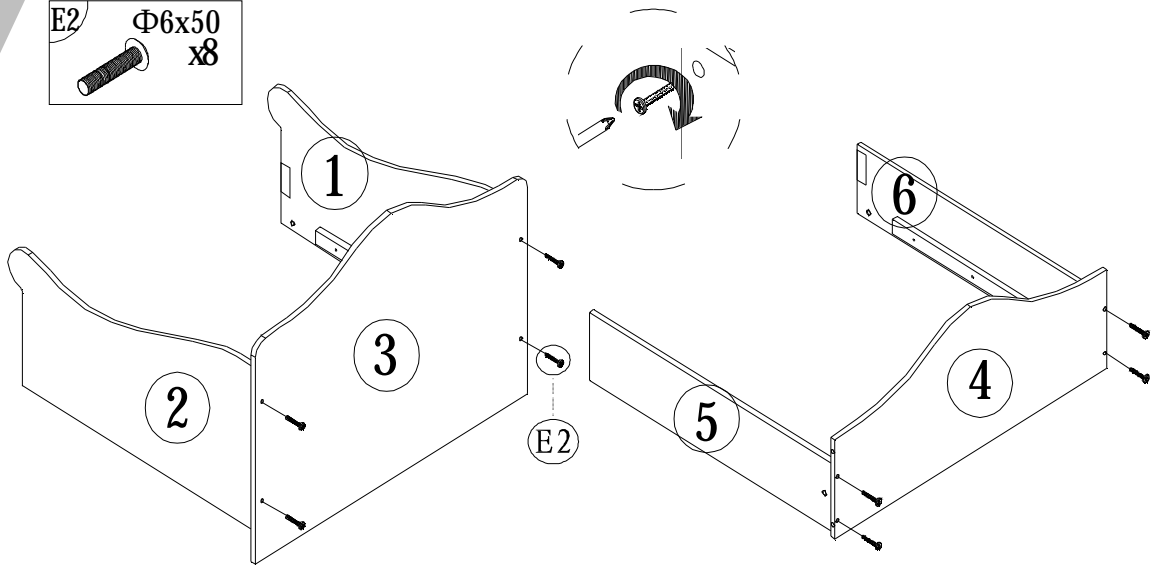
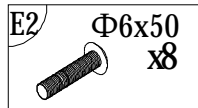

3

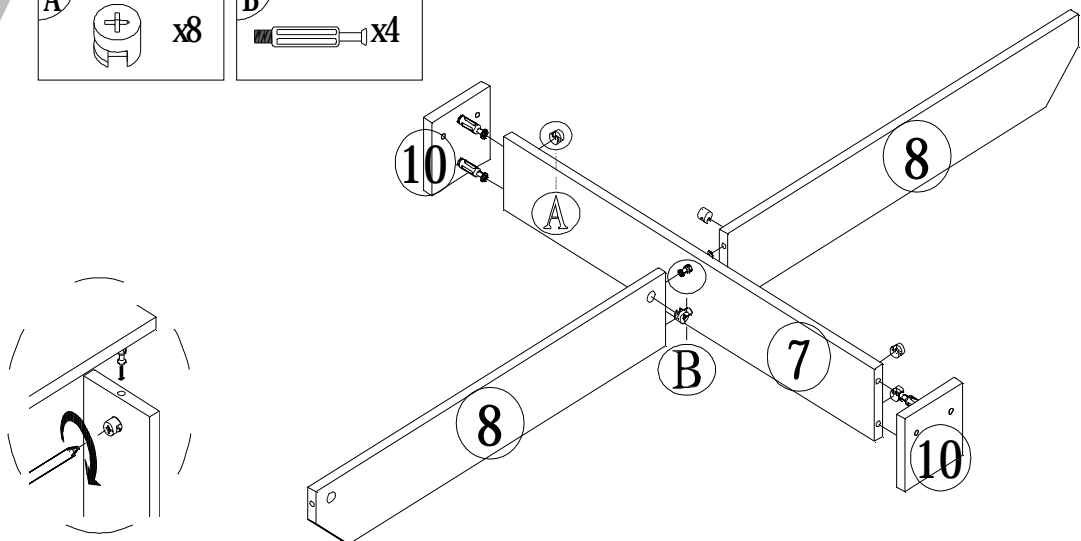
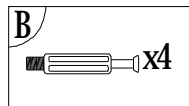
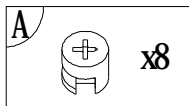

4

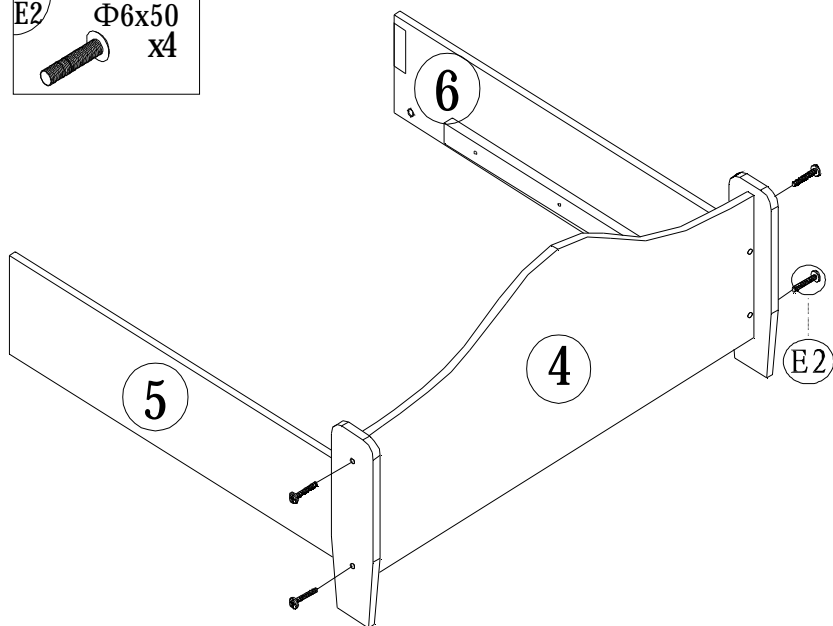

5

A  x2

E  $\Phi 6 \times 20$
x4

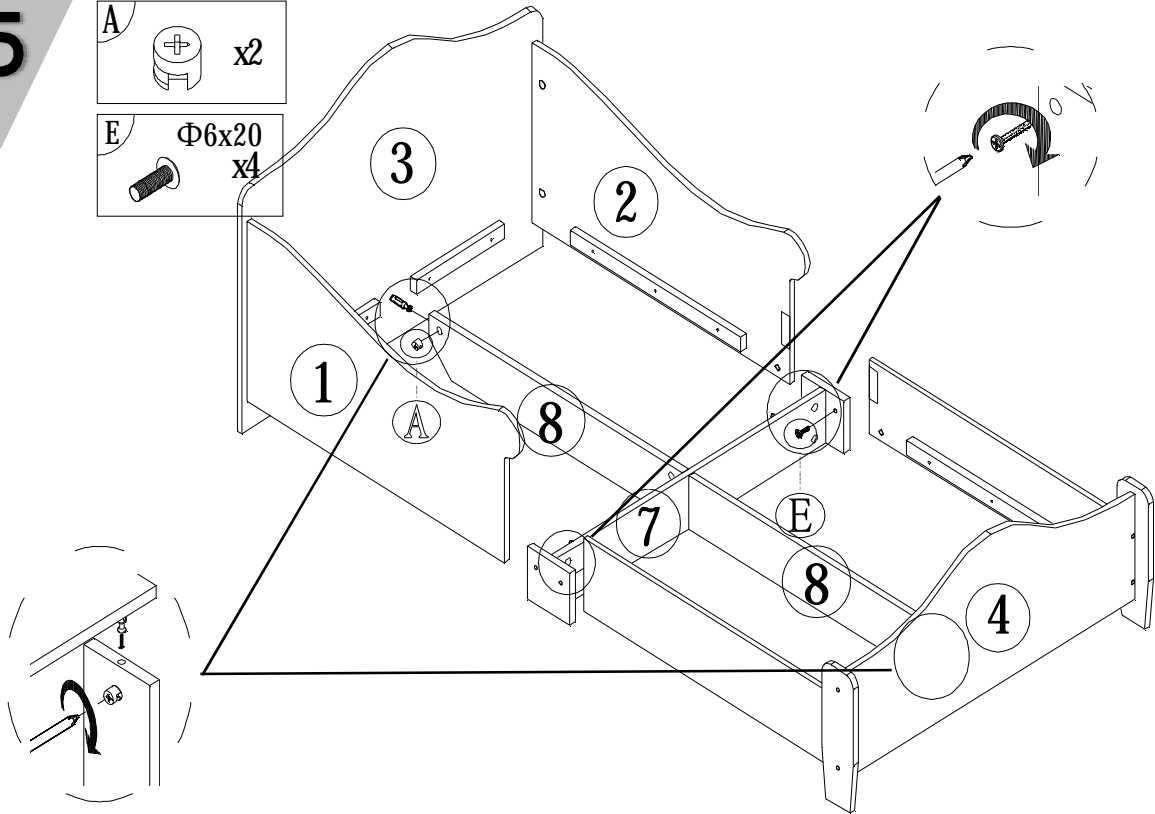

6

F  $\Phi 3.5 \times 12$
x8

F2  $\Phi 3.5 \times 29$
x8

G  x2

