

MONTAGEANLEITUNG INSTRUKCJA MONTAŻOWA

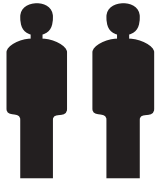

2 Personen
2 Osoby

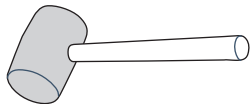
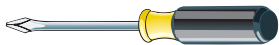
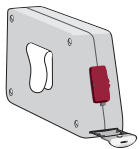

**MONTOWAĆ
 NA ROZŁOŻONYM KARTONIE!**

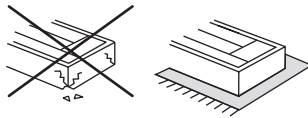

**Wskazówka dotycząca
 pielęgnacji!**

Proszę czyścić tylko suchą
 lub lekko wilgotną szmatką do kurzu.
 Nie używać żadnych środków szorstkich!
 Maksymalne obciążenie półek w kg:

| Stärke/Gr. | Spanplatte/Płyta | | |
|--------------|------------------|----|----|
| Länge/Dł. mm | 15 | 18 | 22 |
| 0<400 | | | |
| 401<600 | 40 | 40 | 40 |
| 601<800 | 24 | | |
| 801<1000 | 15 | 30 | |

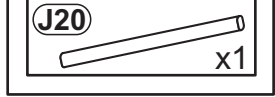
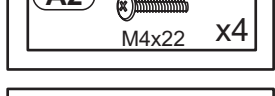
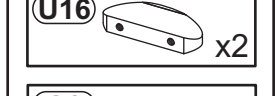
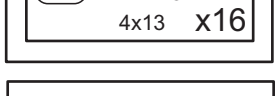
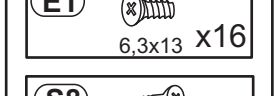
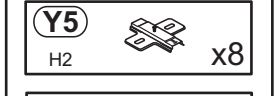
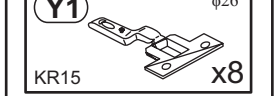
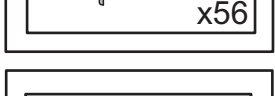
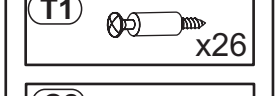
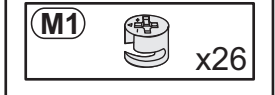
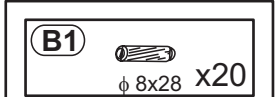
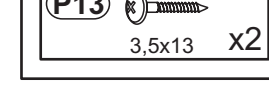
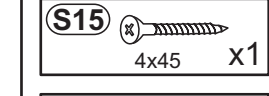
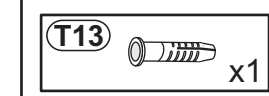
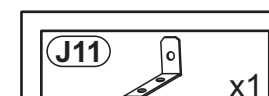
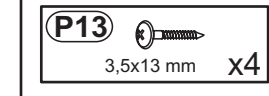
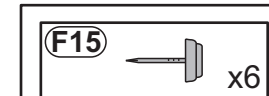
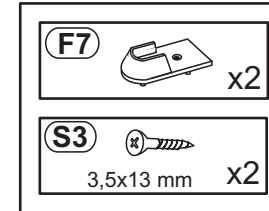
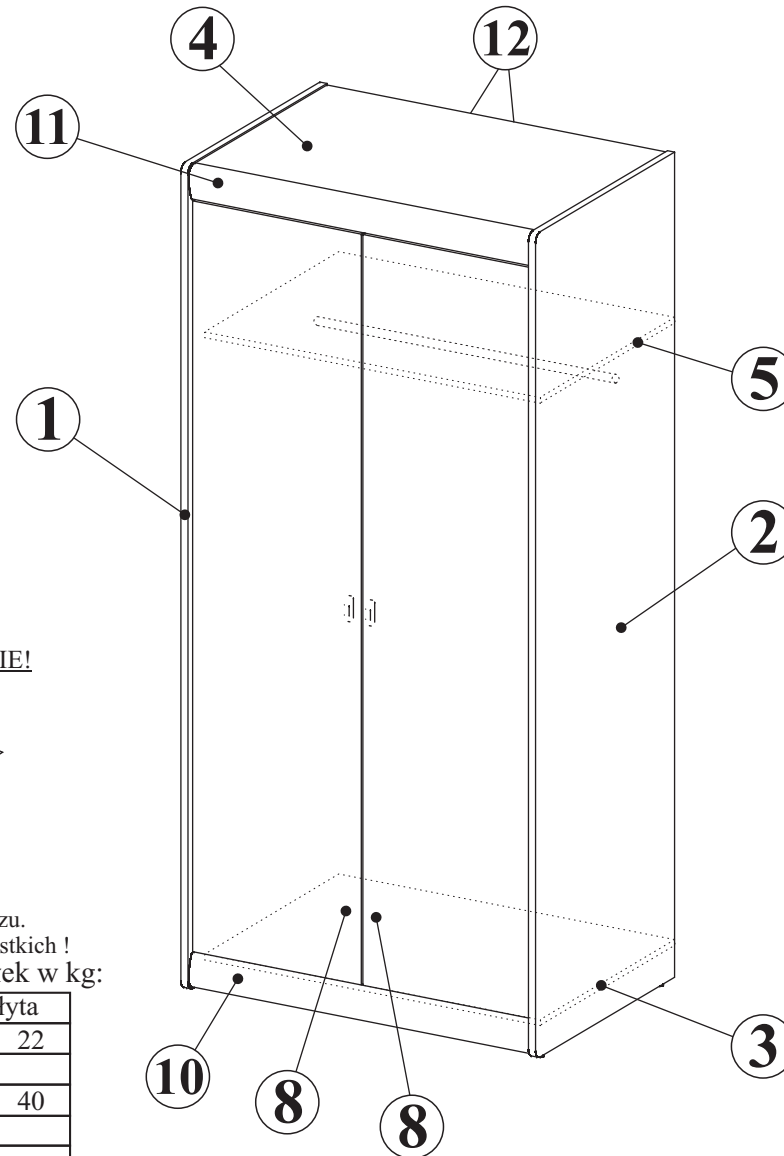

1

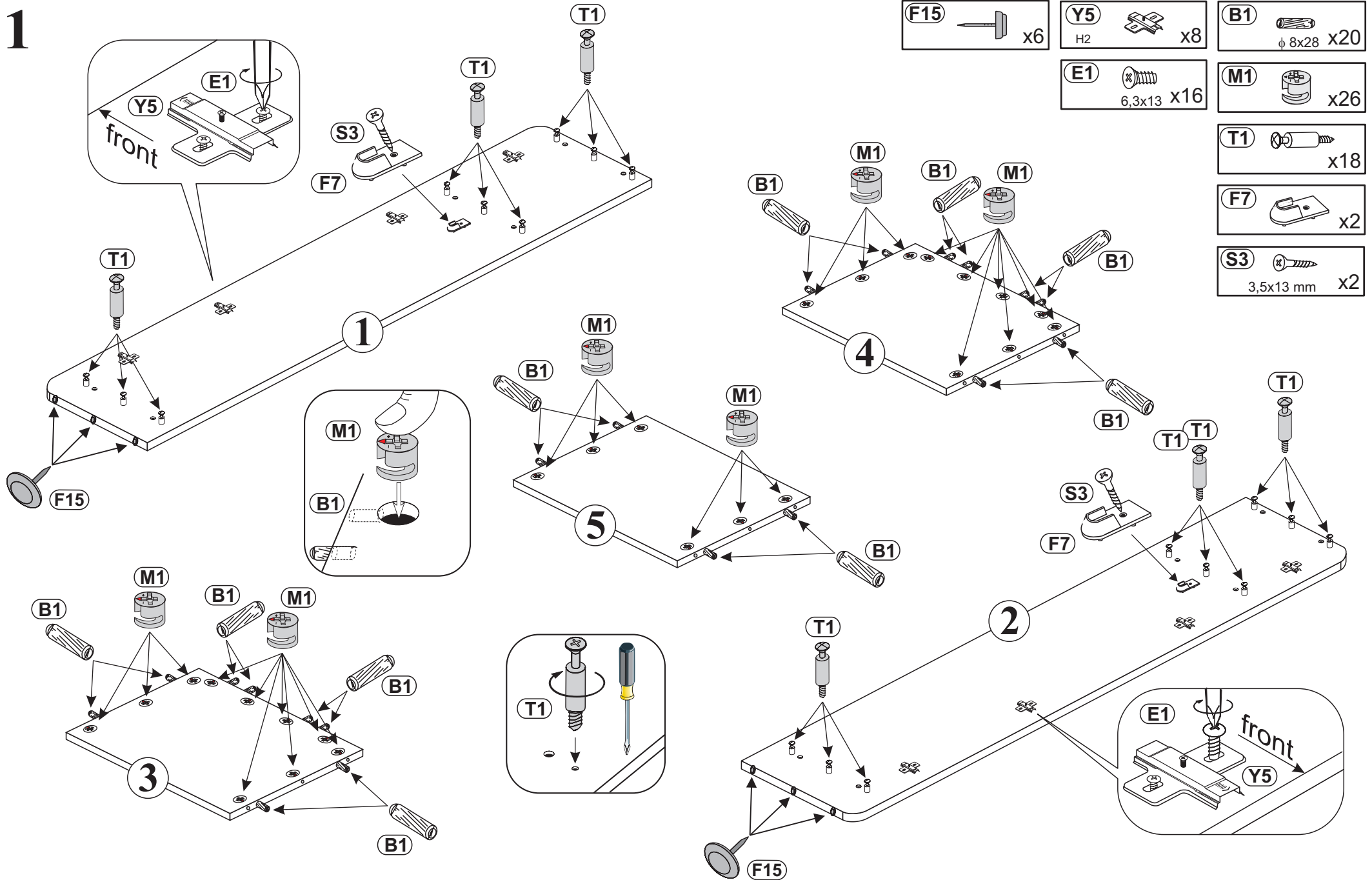

2

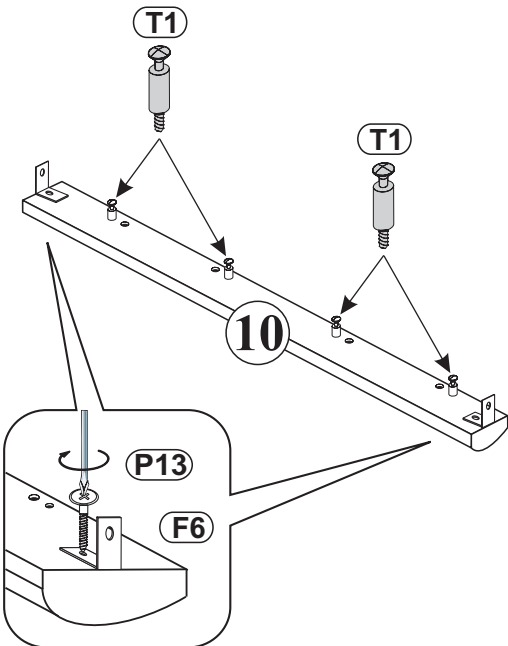
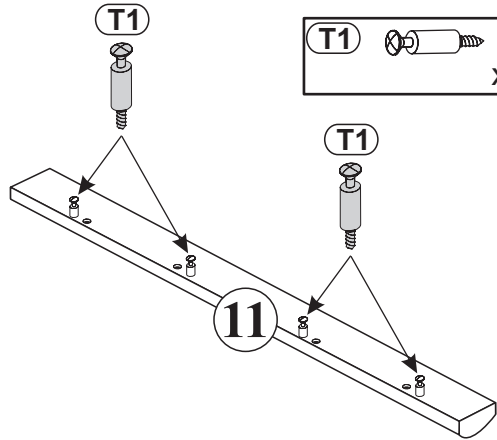
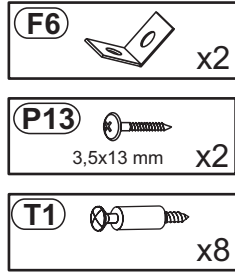

3

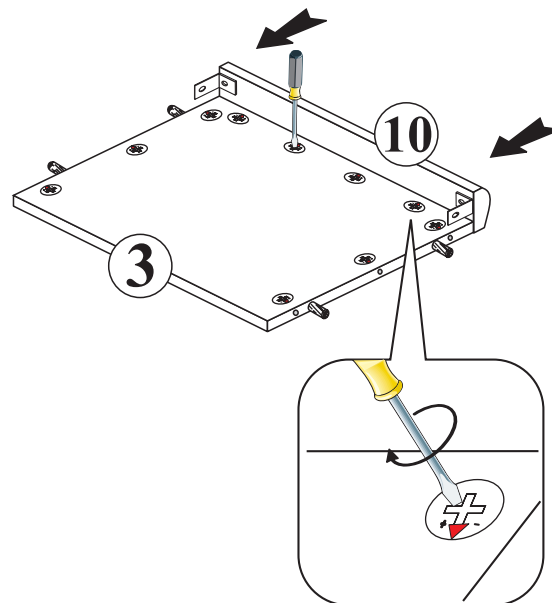
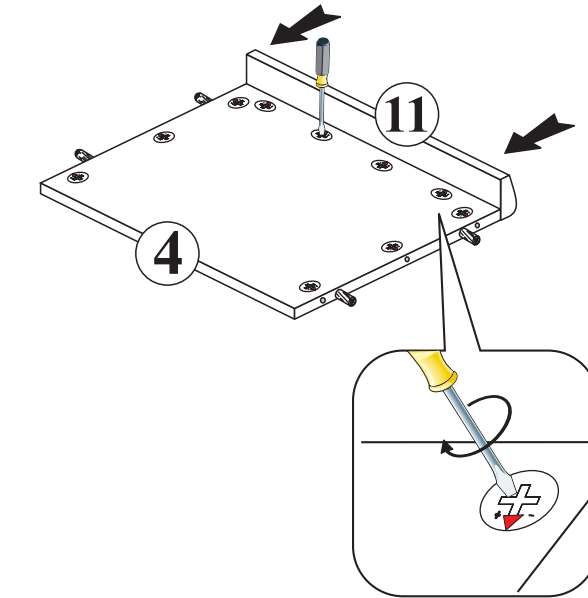

4

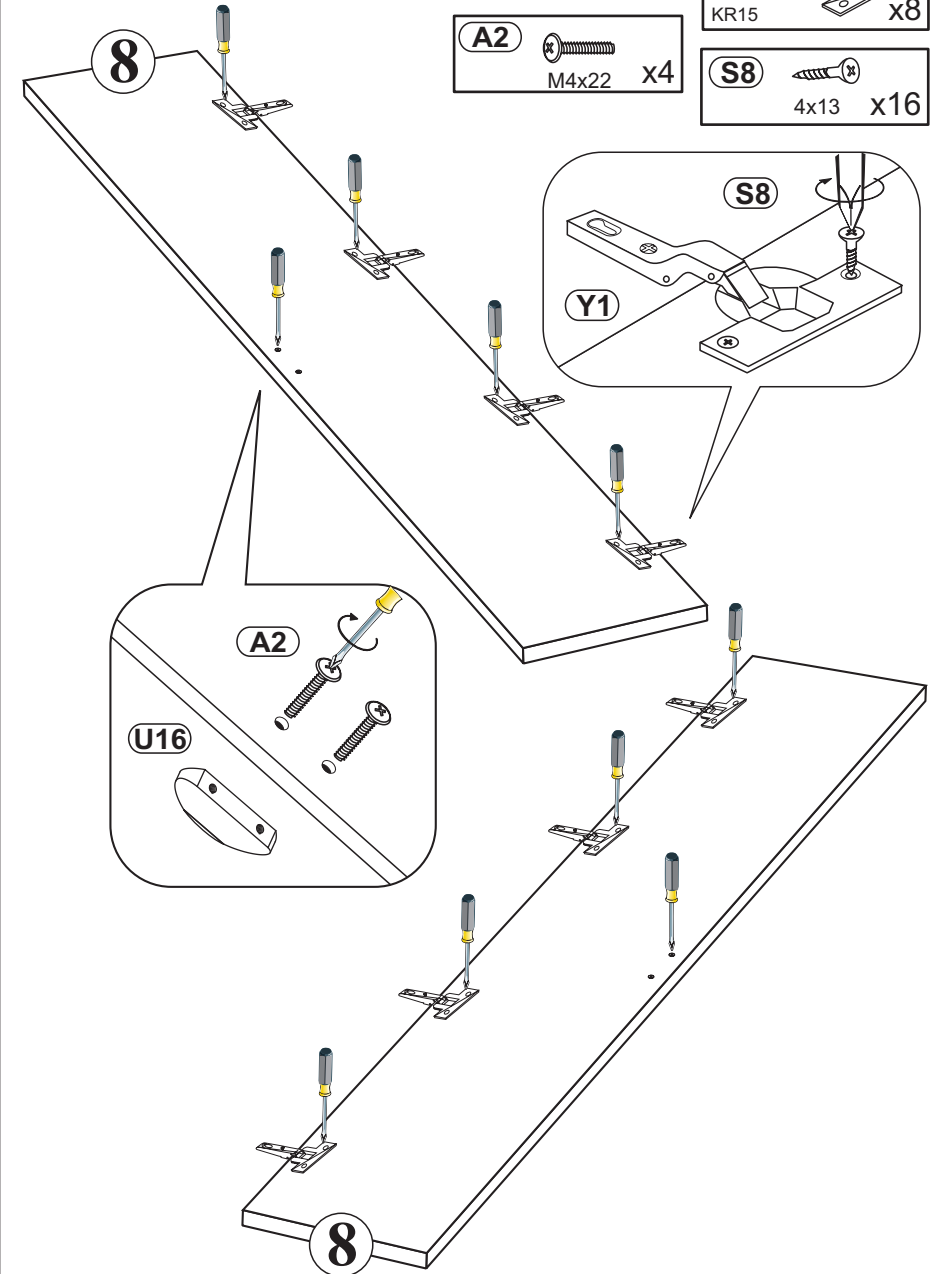
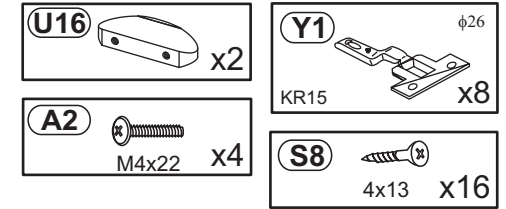

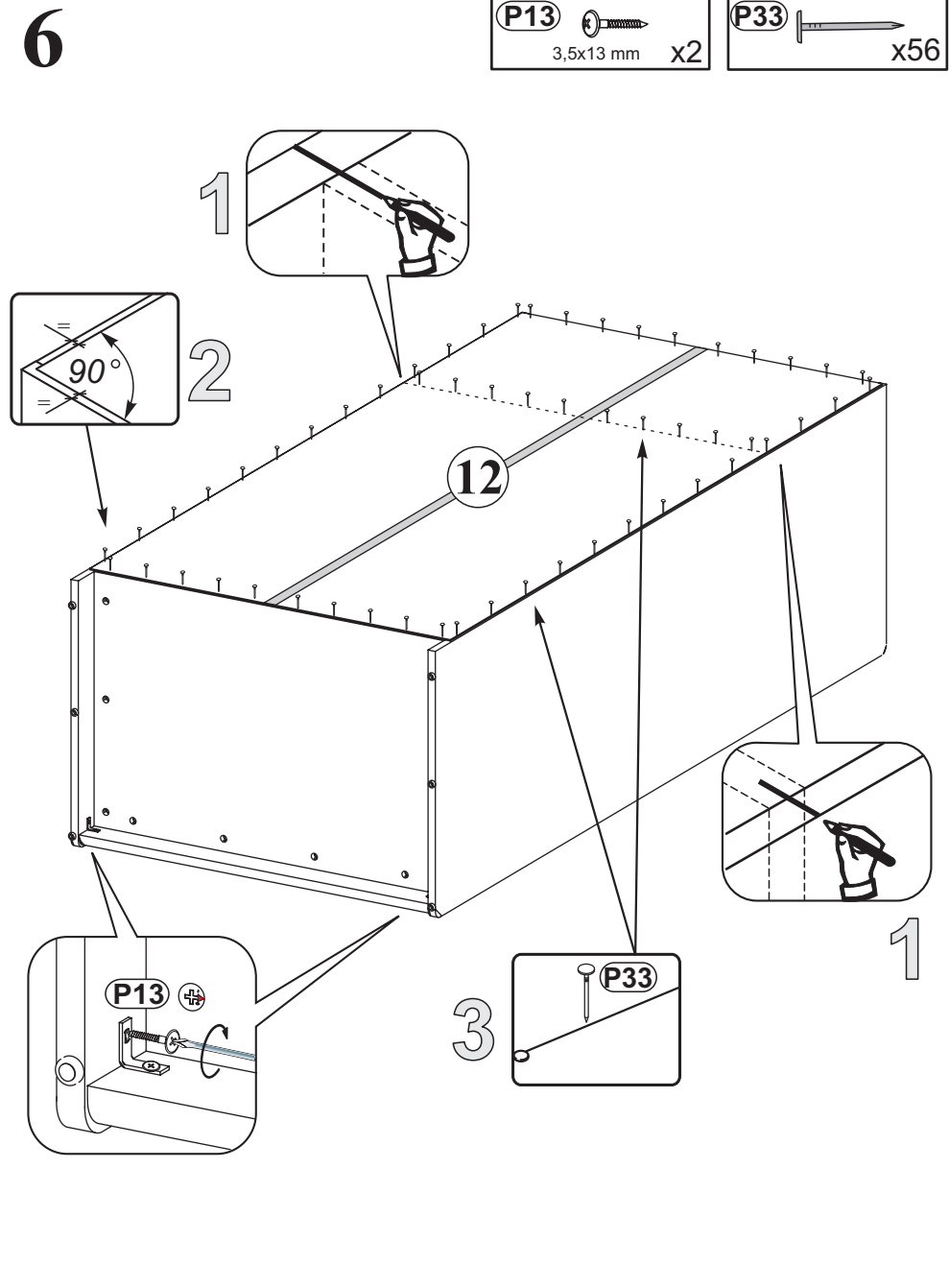
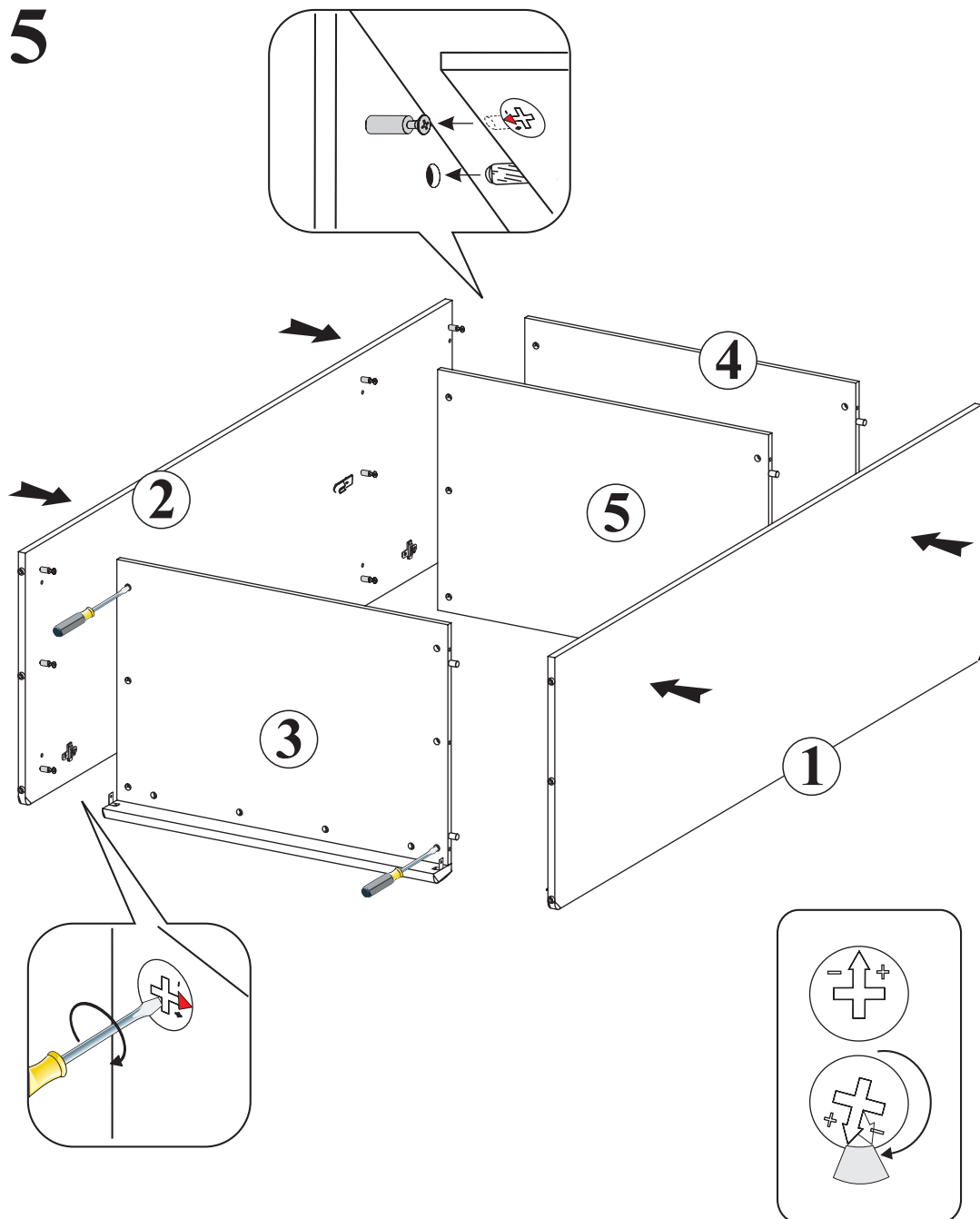

7

