

SAV
 SPAREPARTS
 KUNDERDIENST
 POST VENTAS
 SERVICE NA VERKOOP
 SERVIZIO POST-VENDITA
 SERVIÇO DEPOIS DE VENDA
 SERWIS POGWARANCYJNY

1571 2

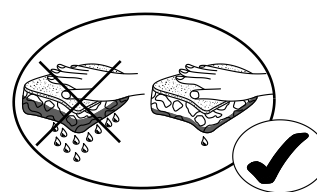

REP	DIM	QTE
1	918 x 244	1
2	916 x 144	1

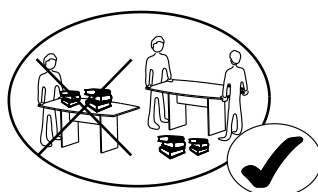
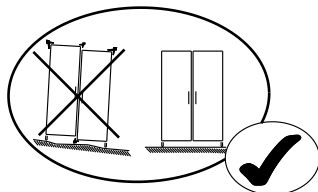
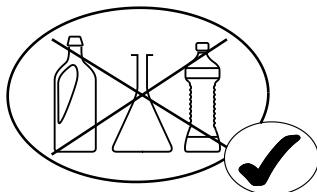
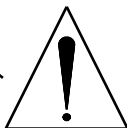
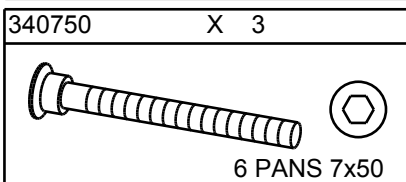
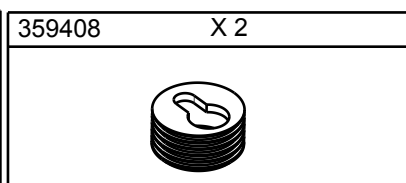
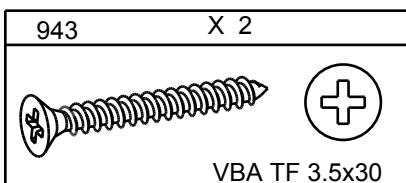
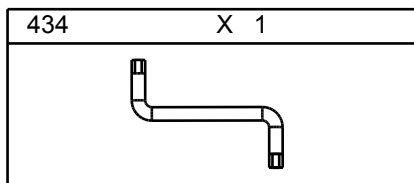
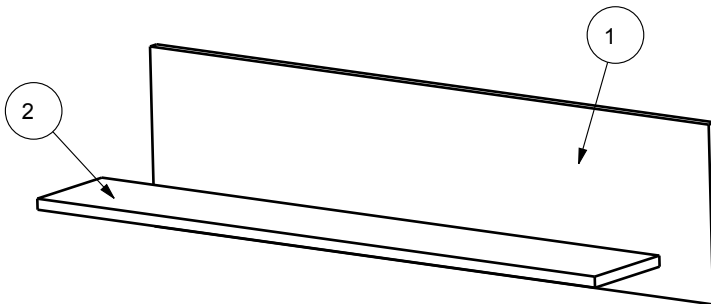

0H 30MN

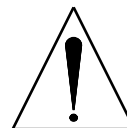

(FR) SECURITE
 RESPECTER LES INSTRUCTIONS DE MONTAGE DECRITES DANS LA NOTICE.

(EN) CAUTION
 FOLLOW CAREFULLY THE ASSEMBLING INSTRUCTIONS DESCRIBED IN THE DIRECTIONS.

(DE) SICHERHEITSVORSCHRIFTEN
 BEACHTEN SIE BITTE UNBEDINGT DIE ANGEGBENEN AUFBAUVORSCHRIFTEN.

(ES) SEGURIDAD
 RESPECTAR LAS INSTRUCCIONES DE MONTAJE DESCRIBIDAS EN EL FOLLETO.

(NL) VEILIGHEID
 DE IN DE GEBRUIKSAANWIJZING BESCHREVEN INSTRUCTIES RESPECTEREN.

(IT) SICUREZZA
 RISPETTARE LE INSTRUZIONI DI MONTAGGIO DESCRITTE NEEL'AVVERTENZA.

(PT) SEGURANCA
 RESPEITAR AS INSTURAÇOS DE MONTAGEM DESCREVEDAS NA INSTRUÇÕES DE USO.

(PL) UWAGA
 PROSZE PRZESTRZEGÁĆ INSTRUKCJI MONTÁZU.

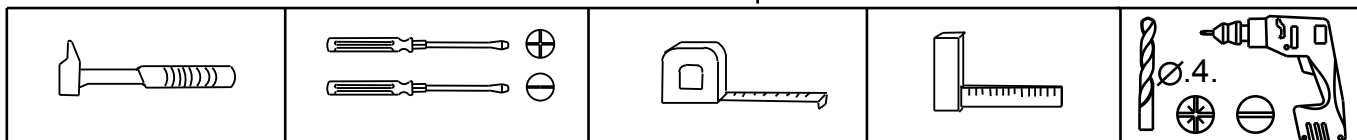

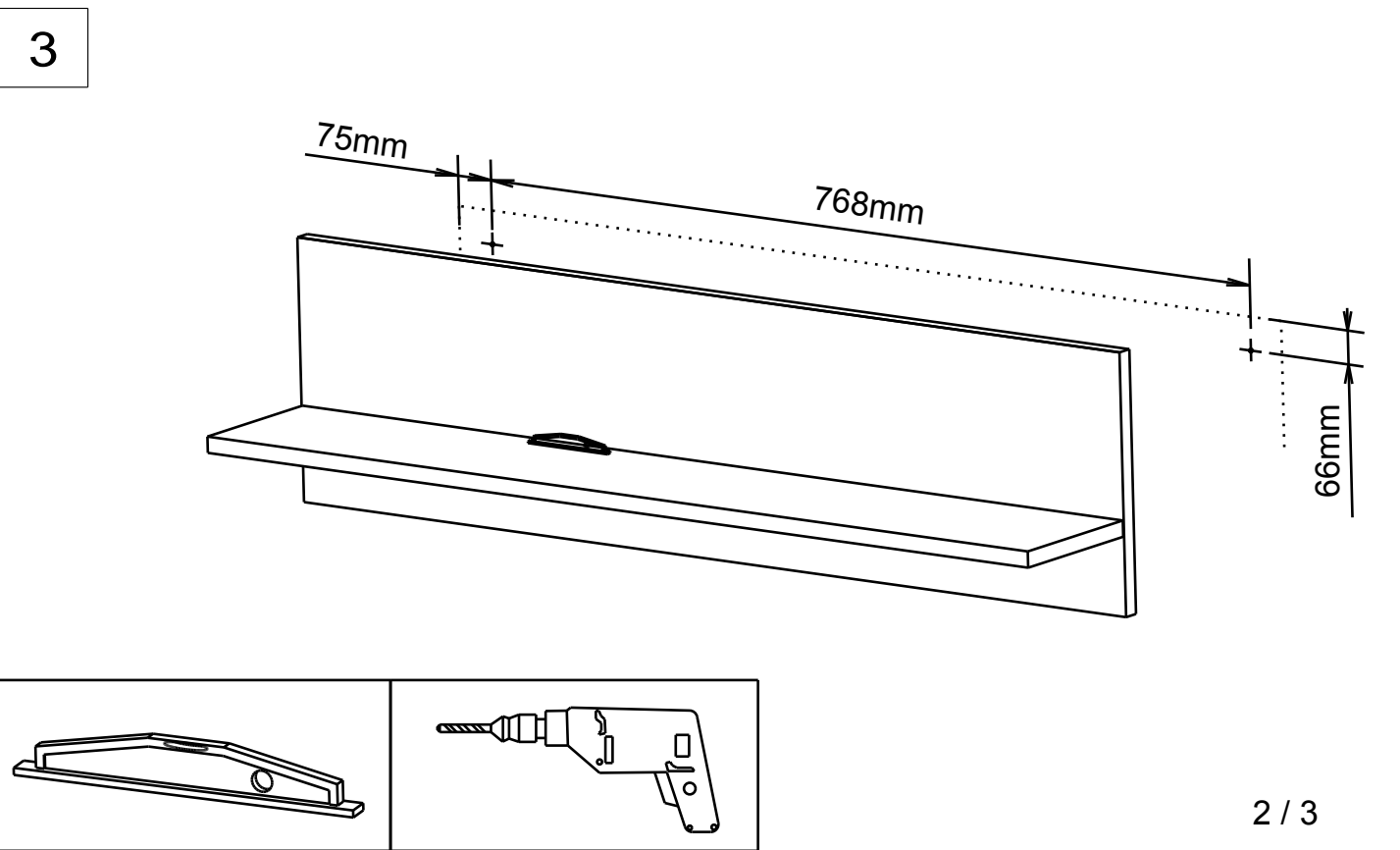
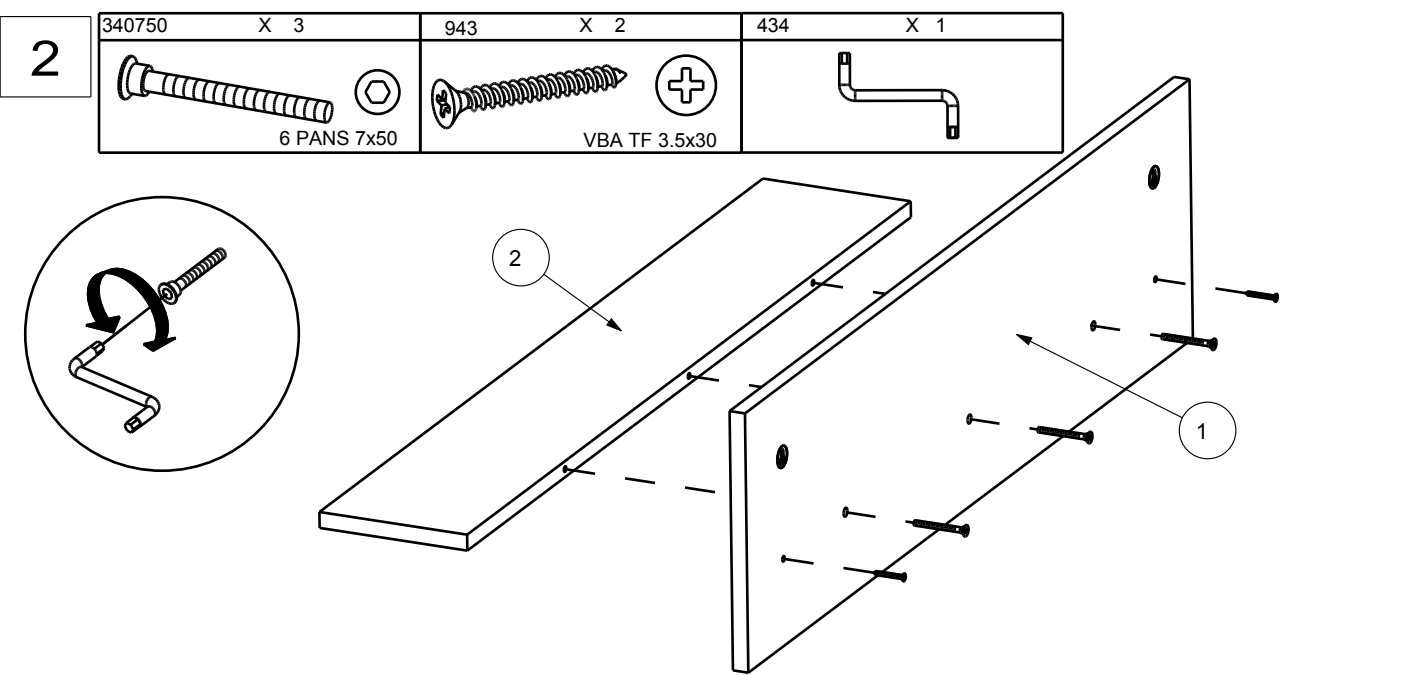
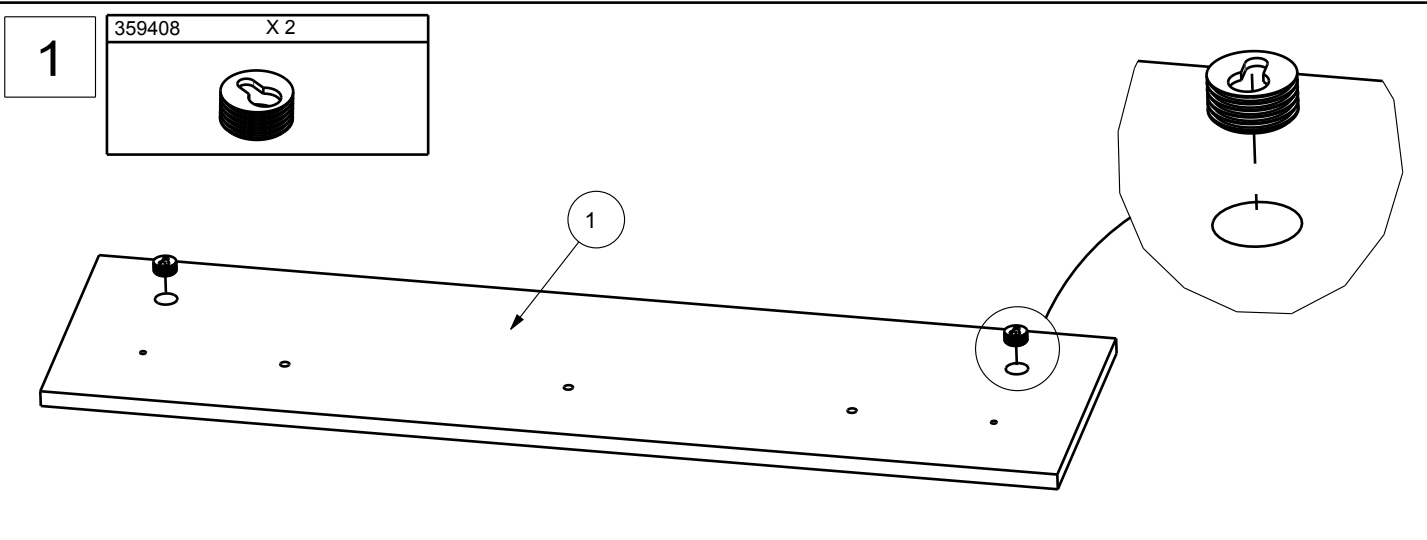

FR MEUBLES A FIXER AU MUR:
 - FIXER LE MEUBLE AU MUR AVEC LES ATTACHES
 PREVUES A CET EFFET
 - VERIFIER QUE LES VIS ET LES CHEVILLES
 UTILISEES SONT ADAPTEES AU SUPPORT

ES MUEBLES A FIJAR EN LA PARED:
 - FIJAR EL MUEBLE EN LA PARED CON LAS
 GRAPAS PREVISTAS
 - COMPROBAR QUE LOS TORNILLOS Y LAS
 CLAVIJAS UTILIZADAS SON ADAPTADAS AL SOPORTE

PT MOVEIS A FIXAR NA PAREDE:
 - FIXAR O MOVEL NA PAREDE COM OS PRENDES
 PREVISTOS
 - VERIFICAR QUE OS PARAFUSOS E AS CAVILHAS
 UTILIZADOS SAO ADAPTADOS OA SUPORTE

EN FURNITURES TO BE HOLD ON THE WALL:
 - HOLD THE FURNITURE ON THE WALL WITH THE
 FASTENINGS PROVIDED FOR THIS PURPOSE
 - CHECK THAT THE SCREW AND PEGS FIT WITH
 THE SUPPORT

IT MOBILI DA FISSARE AL MURO:
 - FISSARE IL MOBILE AL MURO CON LE
 FLANGIE PREVISTE A TALE SCOPO
 - VERIFICARE CHE LE VITI ED I PERNI
 USATI SIANO ADATTI A QUEL TIPO DI
 SUPPORTO

PL MEBEL PRZEZNACZONY DO ZAINSTALOWANIA
 NA ŚCIANIE:
 - NALEZY ZAMONTOWAC TEN MEBEL NA ŚCIANIE
 PRZEZNACZONYMI DO TEGO CELU UCHWYTAMI
 - NALEZY SPRAWDZIC CZY SRUBY I KOSZULKI
 SA ODPOWIEDNIEJ WIELKOSCI W STOSUNKU DO
 UCHWYTOW

DE MOEBEL AN DER MAUER ZU BEFESTIGEN:
 - BEFESTIGEN SIE DAS MOEBELSTUECK MIT DEN
 DAFUER VORGESEHENEN BEFESTIGUNGSHAKEN
 - UEBERPRUEFEN SIE BITTE DASS DIE SCHRAUBEN
 UND DUEBEL MIT DEM MATERIAL DER MAUER
 UEBEREINSTIMMEN

NL MEUBELS DIE AAN DE MUUR GEFIXEERD
 MOETEN WORDEN:
 - FIXEER HET MEUBEL AAN DE MUUR MET DE
 DAARVOOR BESTEMDE HAKEN
 - VERFIEER OF DE GEBRUIKTE SCHROEVEN
 BIJ DE BEVESTIGINGSHAAK HOREN