

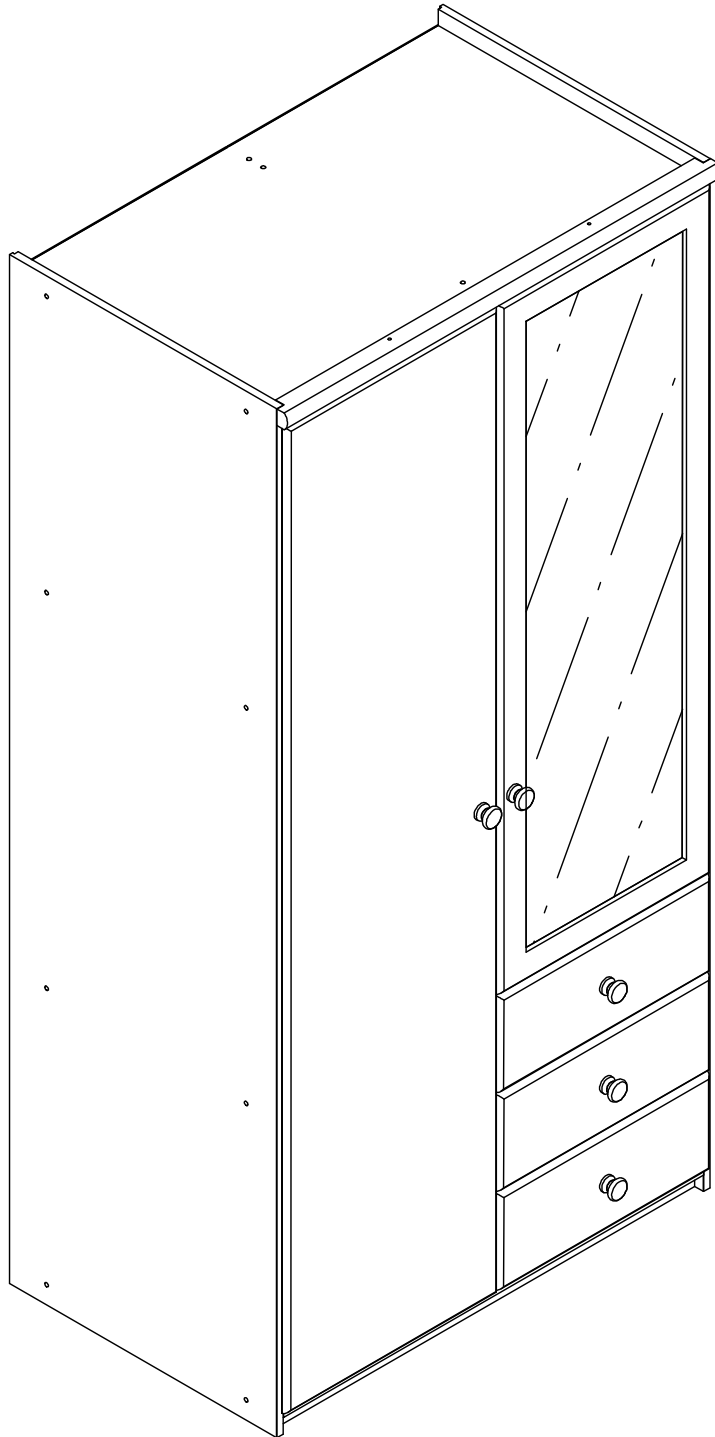

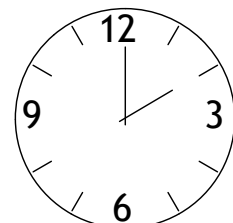

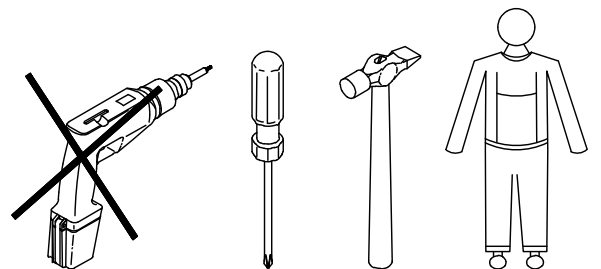

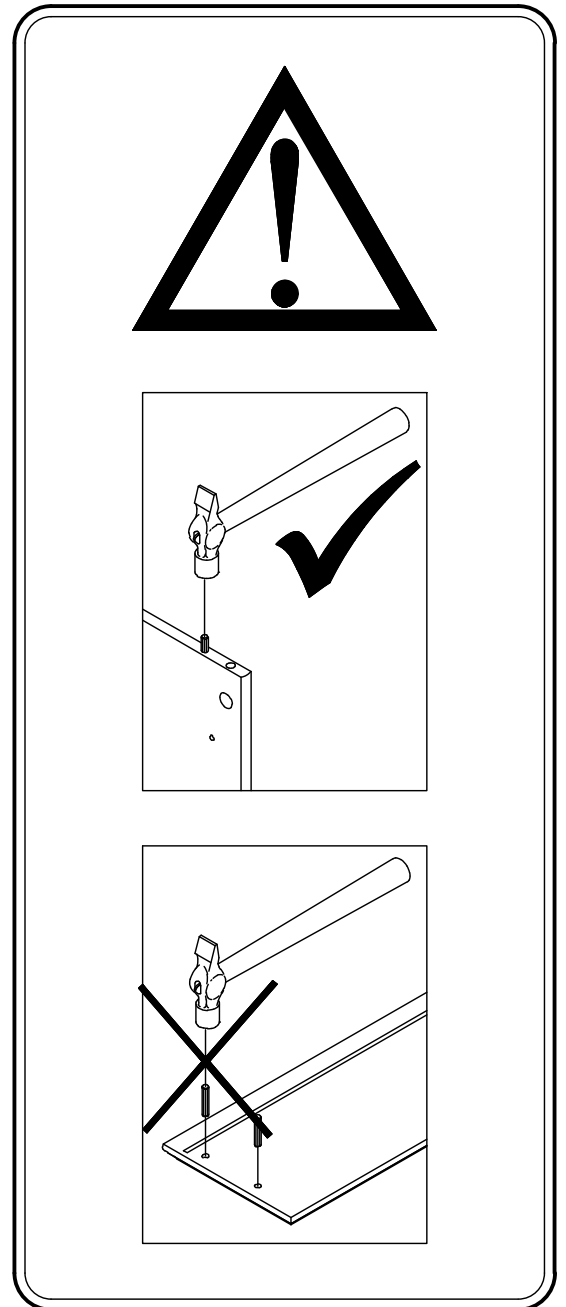

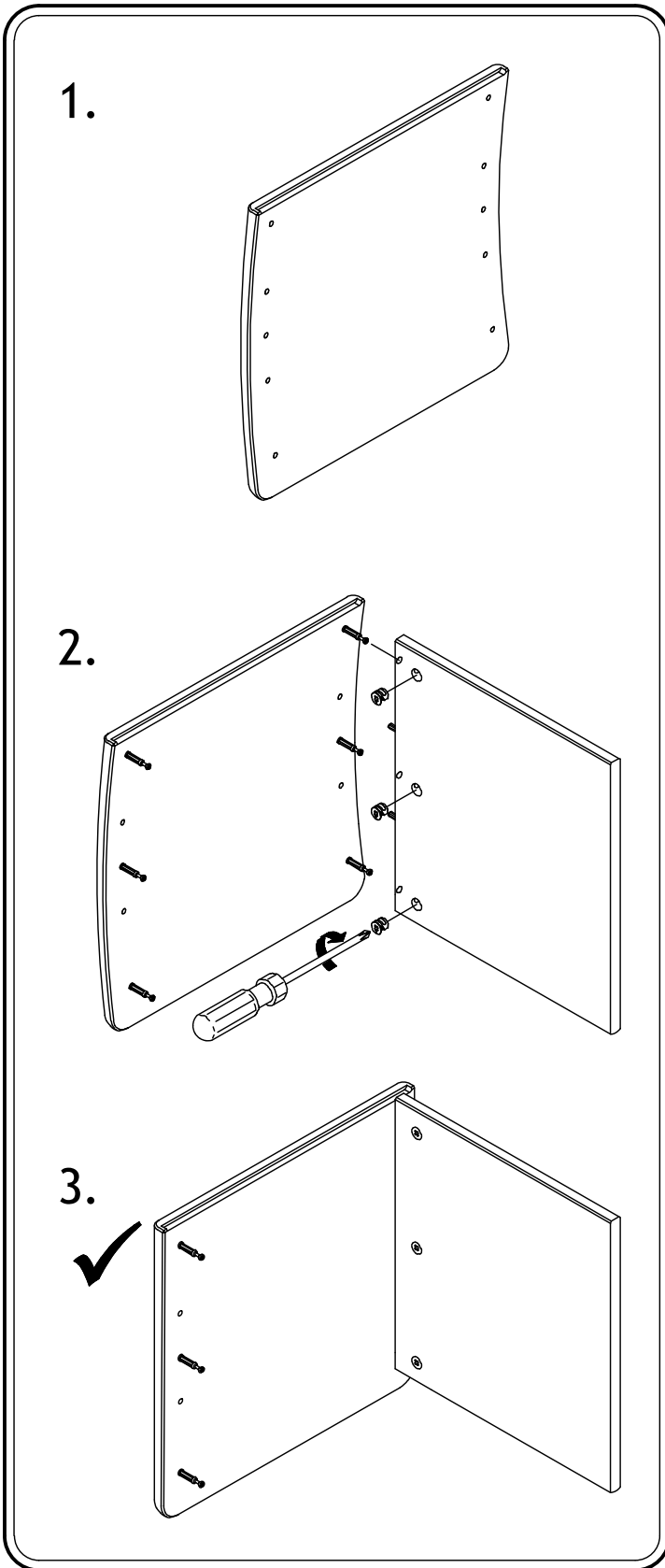
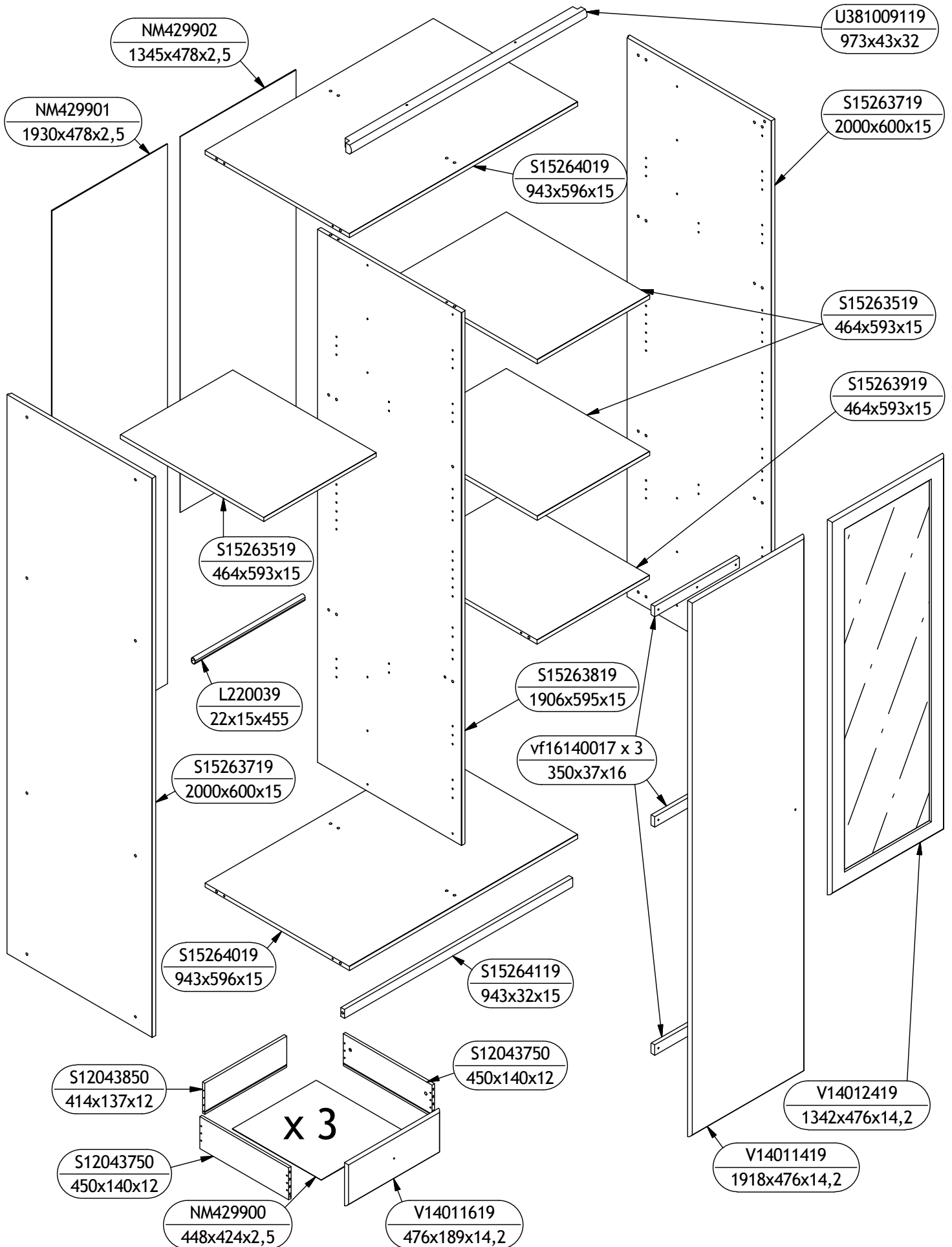
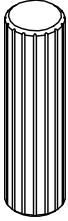
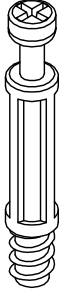
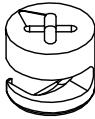

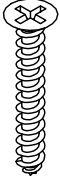
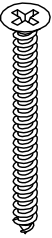
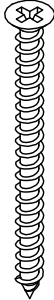

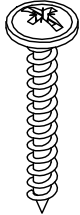
29910619

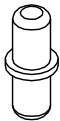
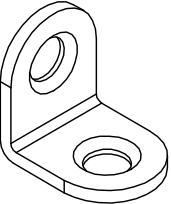

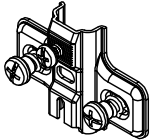
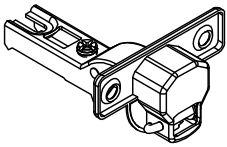
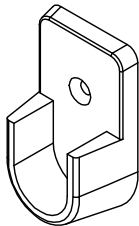
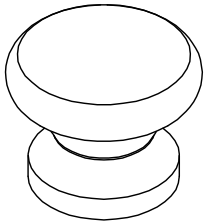
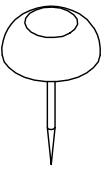

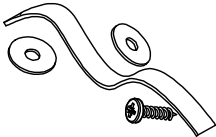
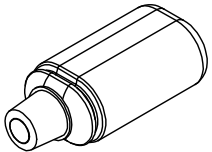
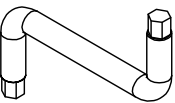

<p>BA10390 x 36 ø8x30</p> 	<p>BA10602 x 6 ø5/8x34</p> 	<p>BA10597 x 6 ø12x10,5</p> 	<p>BA10026 x 100 ø1,2x20</p> 	<p>BA10120 x 26 3,5x12</p> 	<p>BA10131 x 9 4,0x25</p> 
<p>BA10045 x 12 3,5x35</p> 	<p>BA10150 x 2 4,5x45</p> 	<p>BA10310 x 16 7x50</p> 	<p>BA10170 x 5 4,0x35</p> 	<p>BA10273 x 12 ø6,3x9/ø7,0</p> 	<p>BA10830 x 12 5/5</p> 
<p>BA10801 x 2 20x20x2</p> 	<p>BA10276 x 4 ø6,3x9/ø7,8</p> 	<p>BA10532 x 6 0/37 mm</p> 	<p>BA10508 x 6 ø26 / fk 9</p> 	<p>BA10731 x 2 15x22 mm</p> 	<p>BA1043019 x 5 ø40x35 mm</p> 
<p>BA10803 x 4 ø12x18 mm</p> 	<p>BA103464 x 12 ø3/12 mm</p> 	<p>BA103458 x 20 ø9x15x6 mm</p> 	<p>BA10770 x 4 ø10x3 mm</p> 	<p>BA182002 x 1</p> 	<p>I10881 x 1 15 g.</p> 
<p>BA106803 x 1 4 mm / Z</p> 	<p>B14984 x 3 450 mm</p> 