

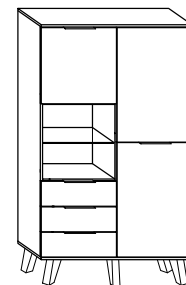

SVN-13 SZAFKA 2D3S

→ 100 ↑ 174 ↘ 40



x 9 	x 18 	x 18 	x 28 	x 6 	x 6 				
x 12 	x 10 (3x16) 	x 52 (3,5x16) 	x 22 (3,5x30) 	x 5 	x 6 			x 110 	x 1
x 5 	x 3 kpl. (350 mm) 		x 1 (300 mm) 					90 min 	

1 - FAZY MONTAŻU

A - OZNACZENIE ELEMENTÓW

a - OZNACZENIE AKCESORIÓW

1

x 3 	x 6
---------	---------

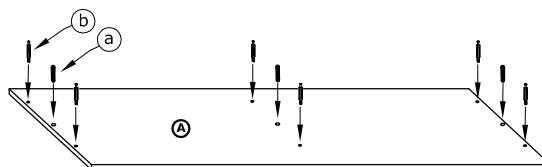

2

x 6 	x 12
x 6 	x 12
x 18 (3,5x16) 	
x 3 kpl. 	

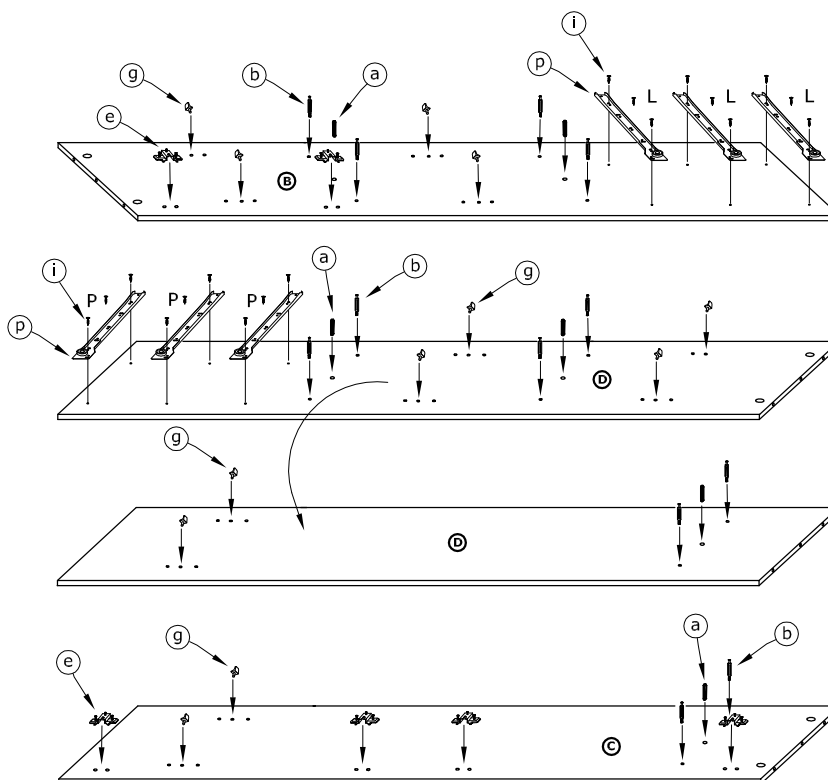

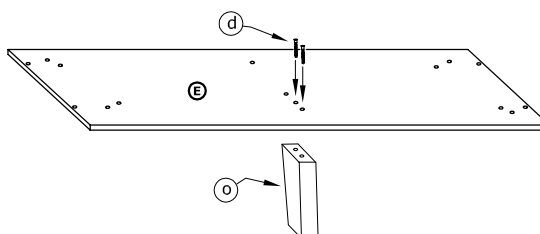

3

x 2
x 1



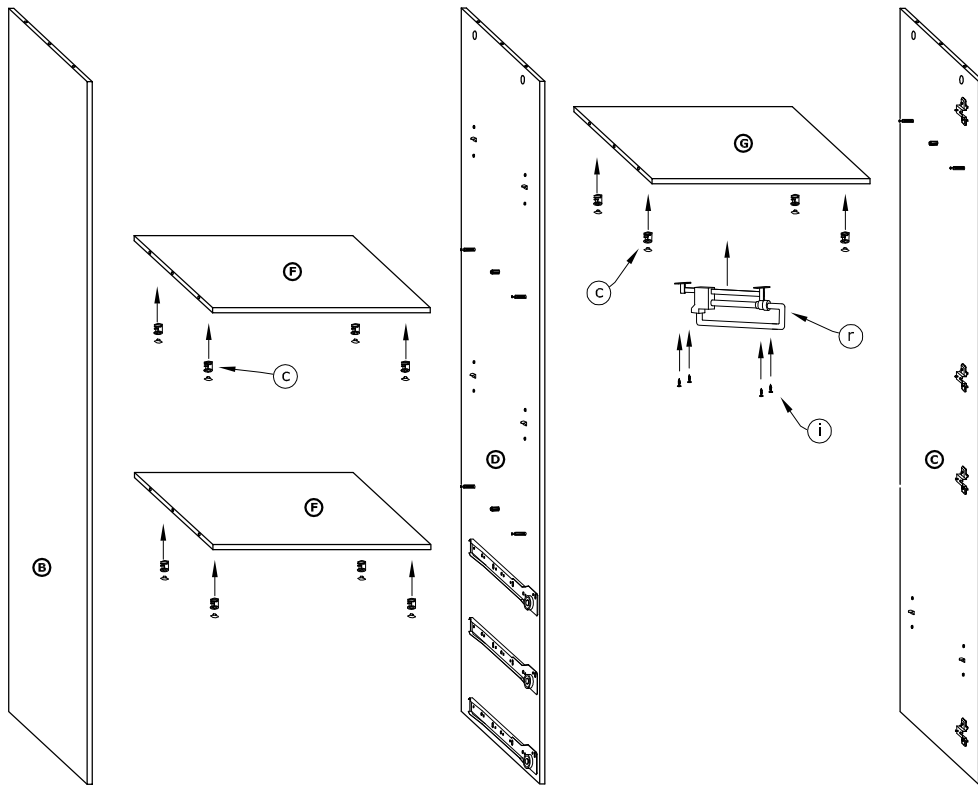

4

- x 12

- x 4
(3,5x16)

- x 1



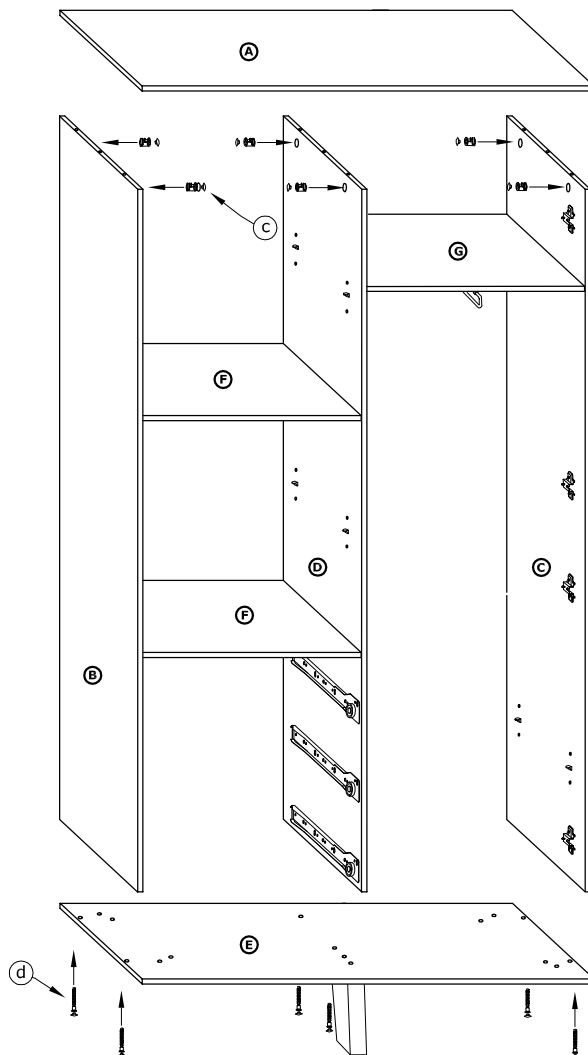



5

- x 6

- x 6





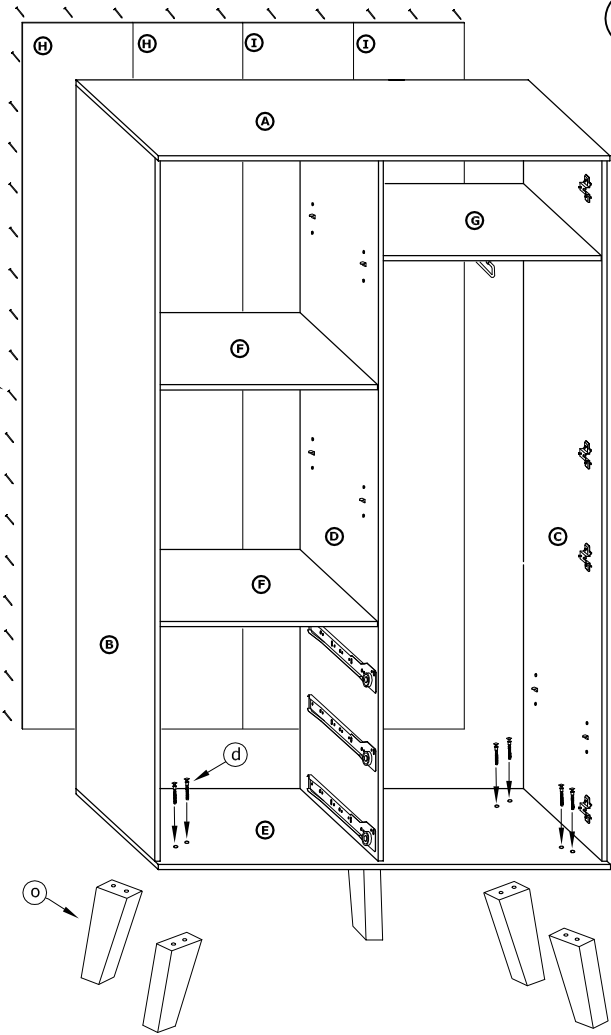







6

- x 8 
- x 65 
- x 4 





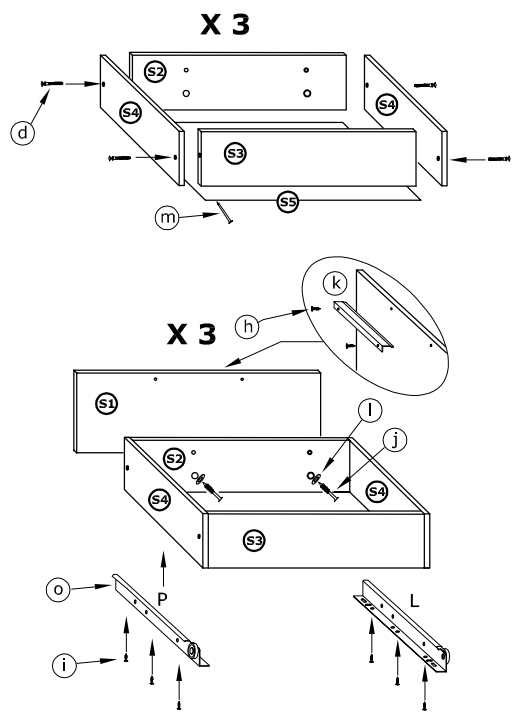

7

- | | | | |
|---|--|---|--|
| x 12  | x 6 (3x16)  | x 18 (3,5x16)  | x 6 (3,5x30)  |
| x 3  | x 6  | x 45  | |
| x 3 kpl.   | | | |



8

- x 6 
- x 4 (3x16) 
- x 12 (3,5x16) 
- x 16 (3,5x30) 
- x 2 