











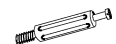

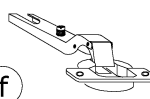
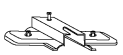

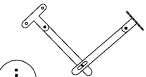

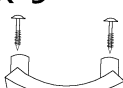

x 12  a	x 3  b	x 24  c	x 4  d	x 32  e	x 11  f
x 11  g	x 5  h	x 2  i	x 12  j	x 9  n	x 8  o
x 6 (6,2x16)  p	x 48 (3,5x30)  r	x 92 (3,5x16)  s	x 100  t	x 1  u	x 1  w
X 4 (400 mm - kpl.)  k	X 1 kpl.  l	X 1 (300 mm)  m		 	

1 - FAZY MONTAŻU

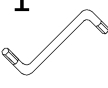
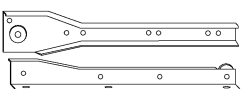
A - OZNACZENIE ELEMENTÓW

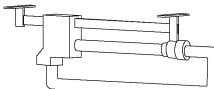
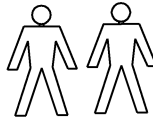
a - OZNACZENIE AKCESORIÓW

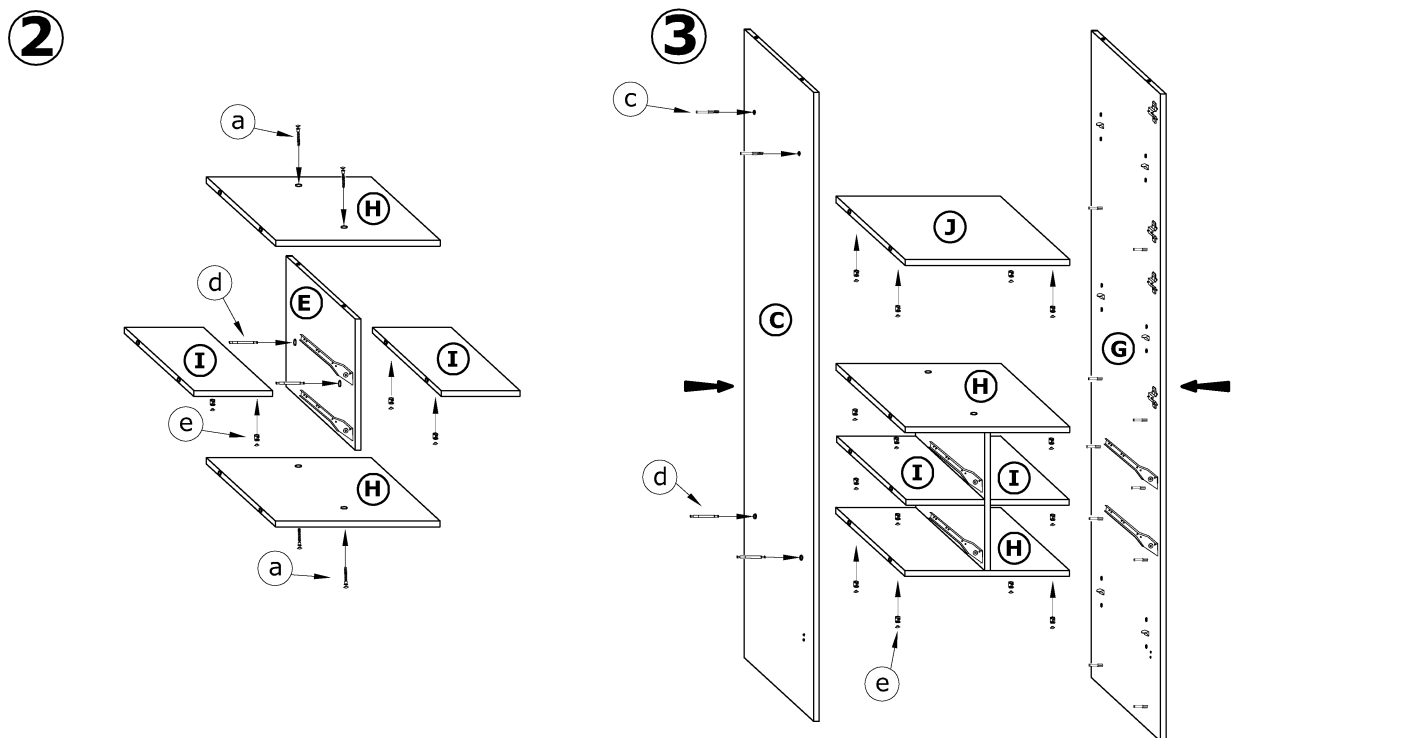
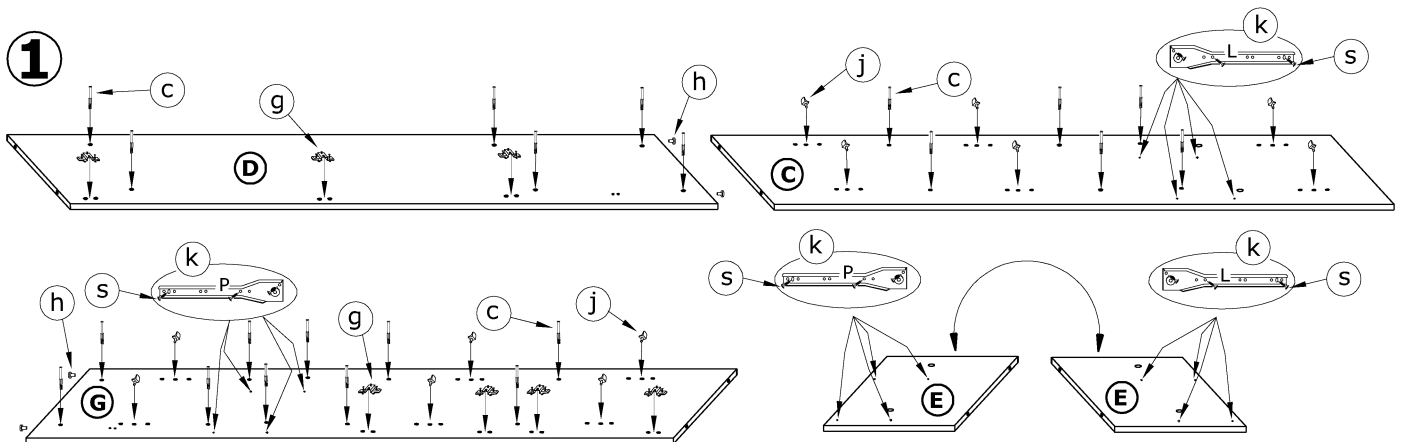

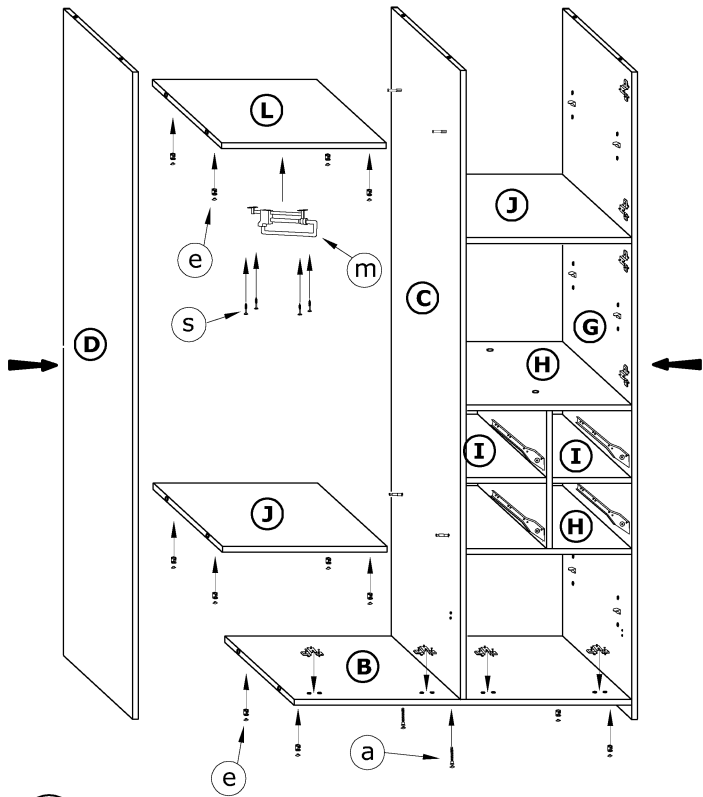
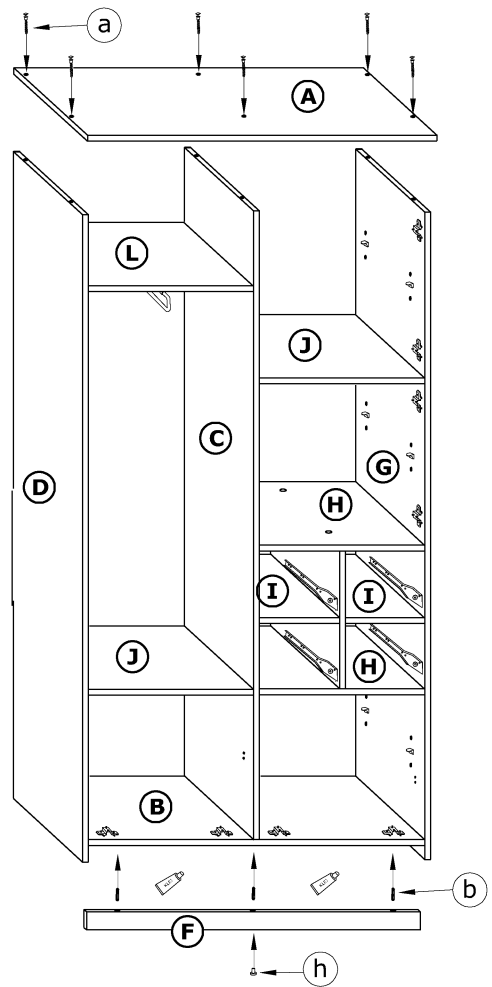
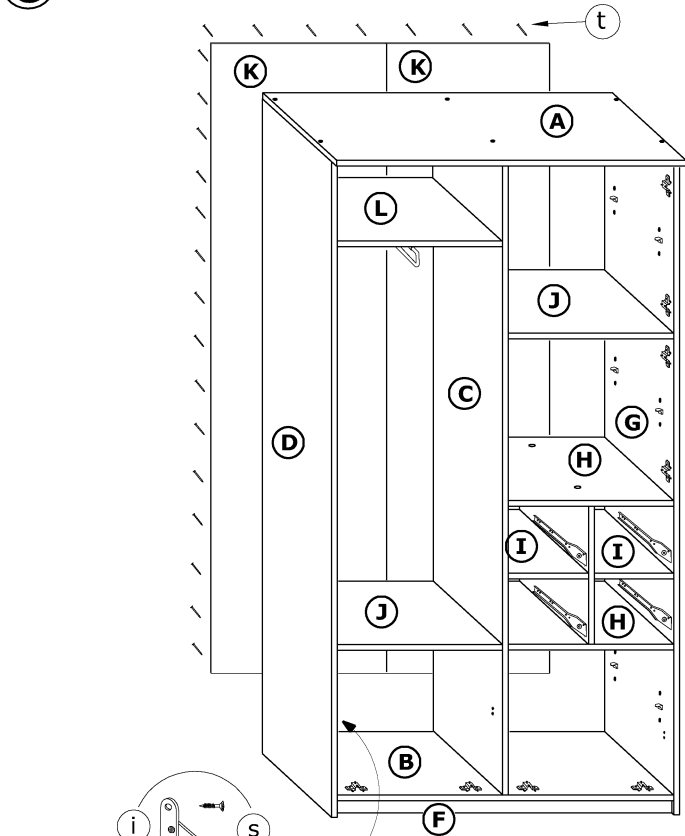
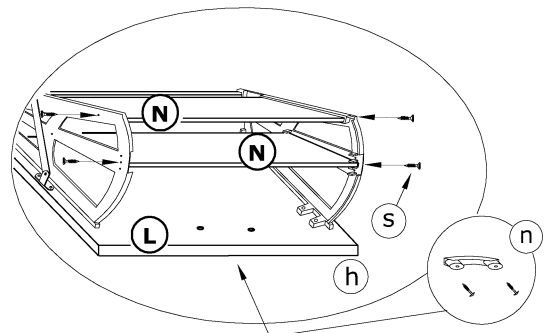
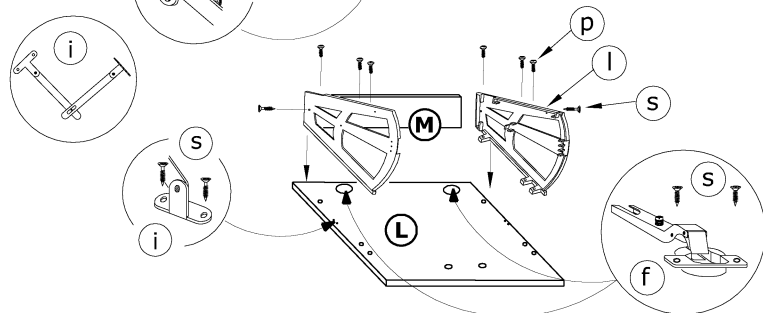
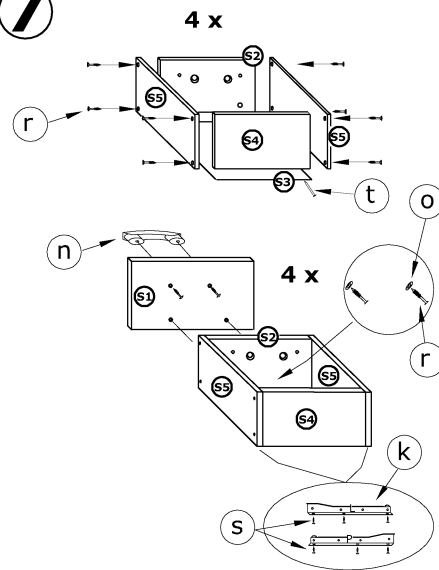
4**5****6****7**

8

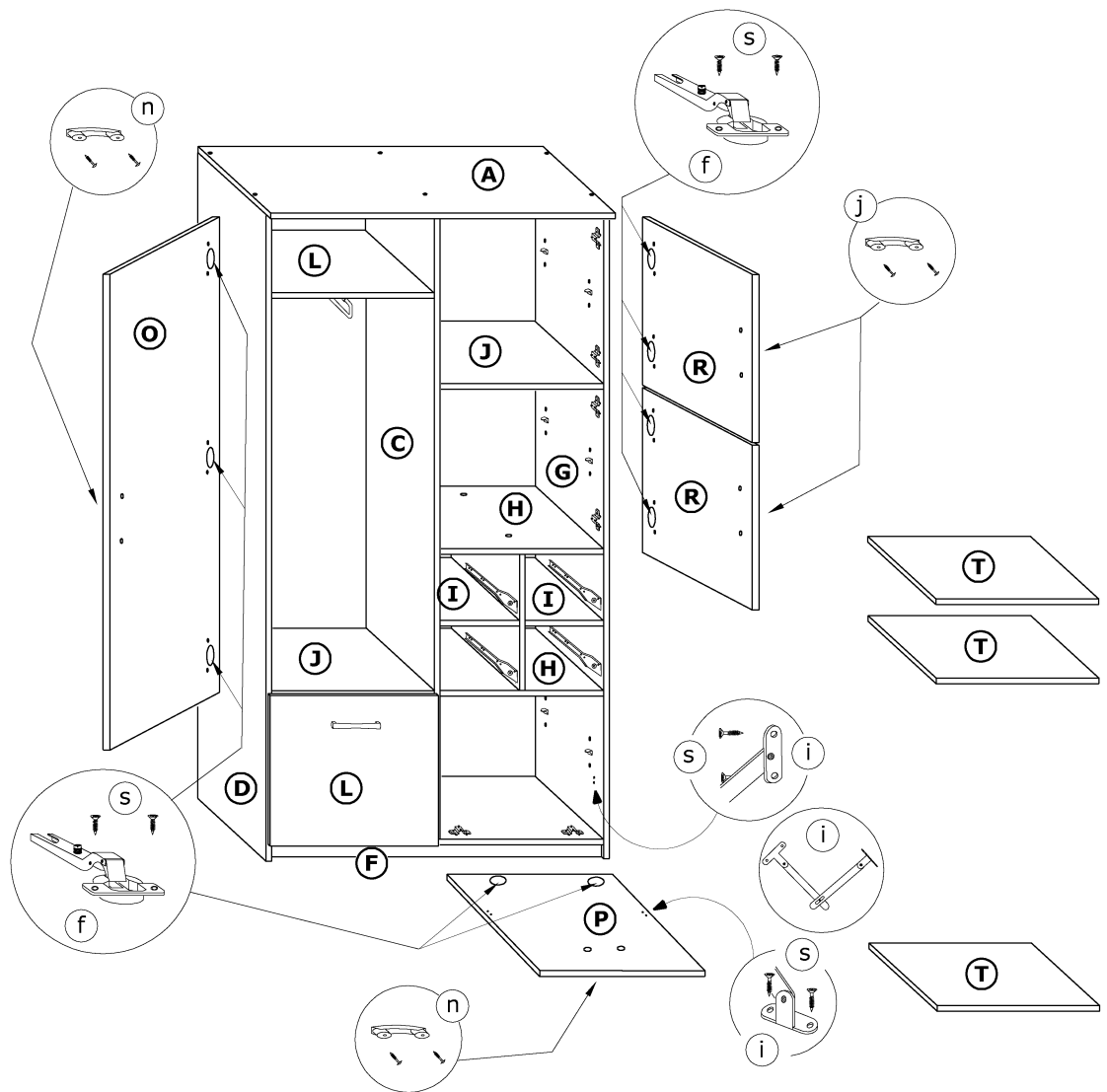

9

