

MEBLO
CROSS
1984

PLAY
- 80 x 75 x 80

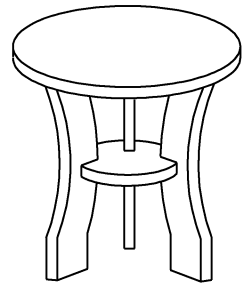

x 3

a

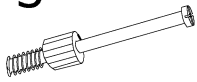

x 3

b

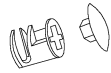

x 6

c



x 6 (3,5x16)

d



x 3

e



x 3

f



15 min

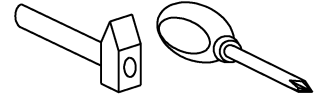
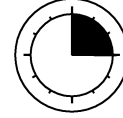

1 - FAZY MONTAŻU

A - OZNACZENIE ELEMENTÓW

a - OZNACZENIE AKCESORIÓW

1

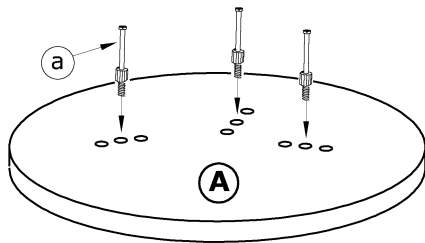

2

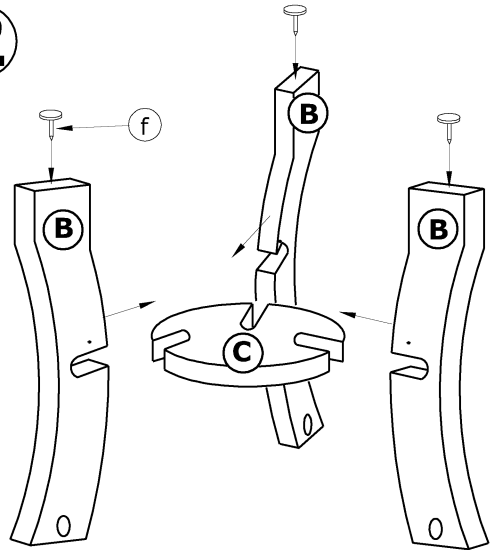

3

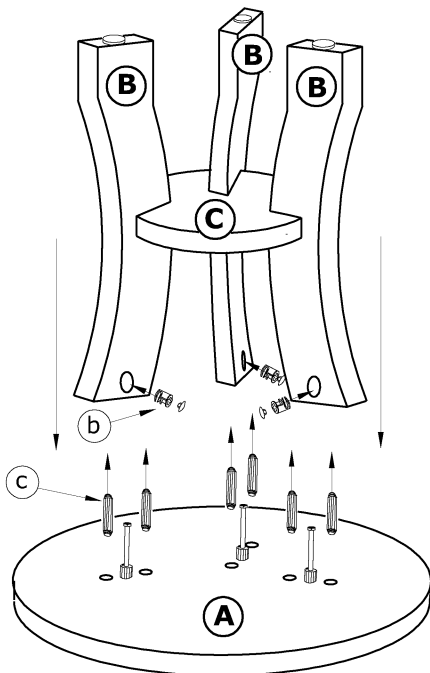

4

