

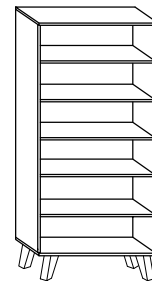

# SVN-07 REGAŁ

→ 80 × 174 × 38



|          |          |          |          |  |
|----------|----------|----------|----------|--|
| x 6<br>  | x 12<br> | x 12<br> | x 12<br> |  |
| x 12<br> | x 70<br> |          | x 1<br>  |  |
| x 4<br>  |          |          |          |  |

**1** - FAZY MONTAŻU

**A** - OZNACZENIE ELEMENTÓW

**a** - OZNACZENIE AKCESORIÓW

**1**

x 2

x 4

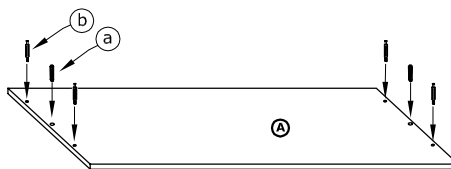

**2**

x 4

x 8

x 12

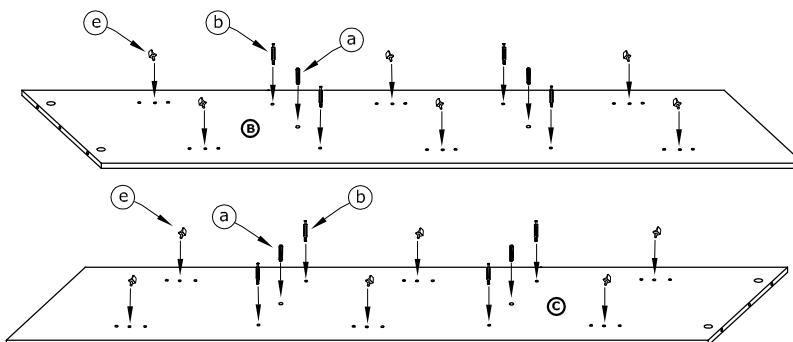

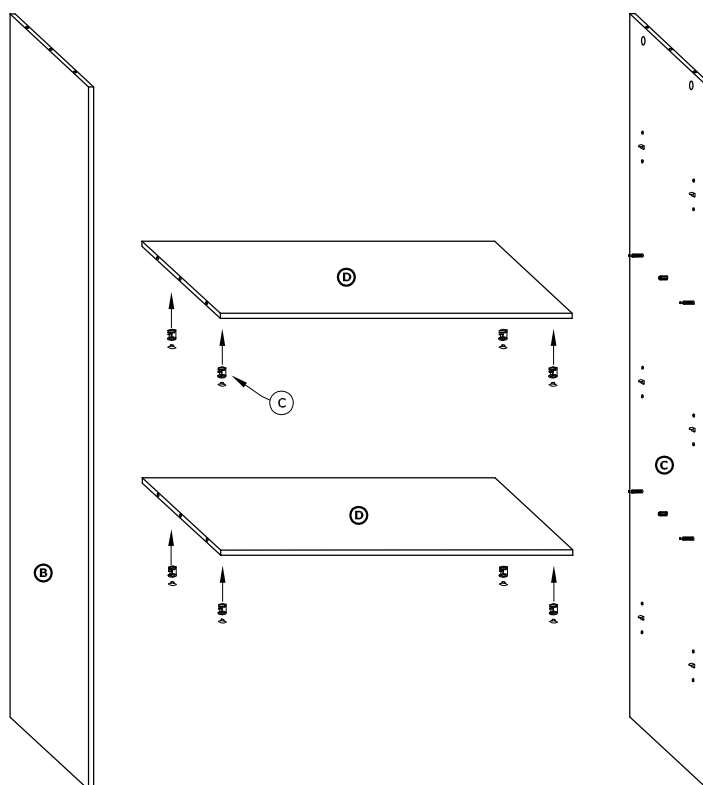

**3**

x 8



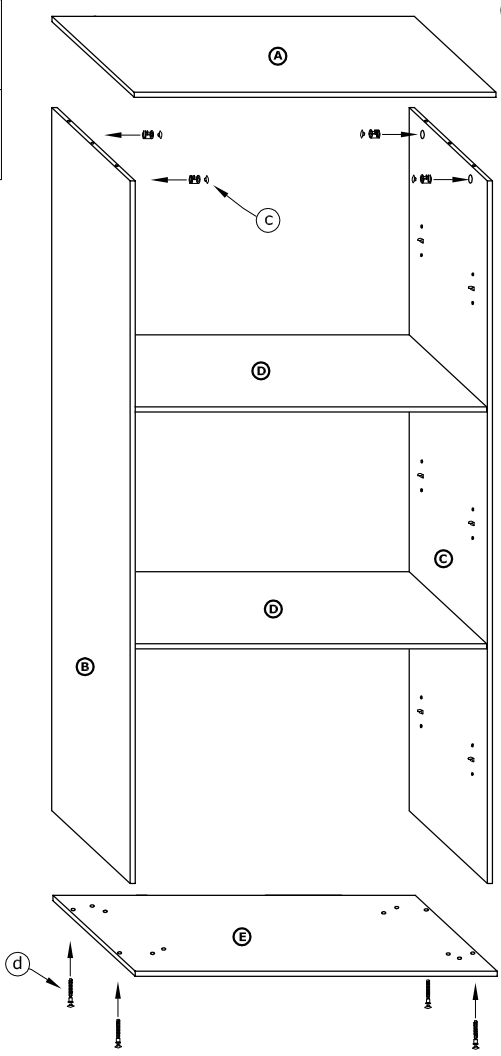

4

- x 4 
- x 4 



5

- x 8 
- x 70 
- x 4 

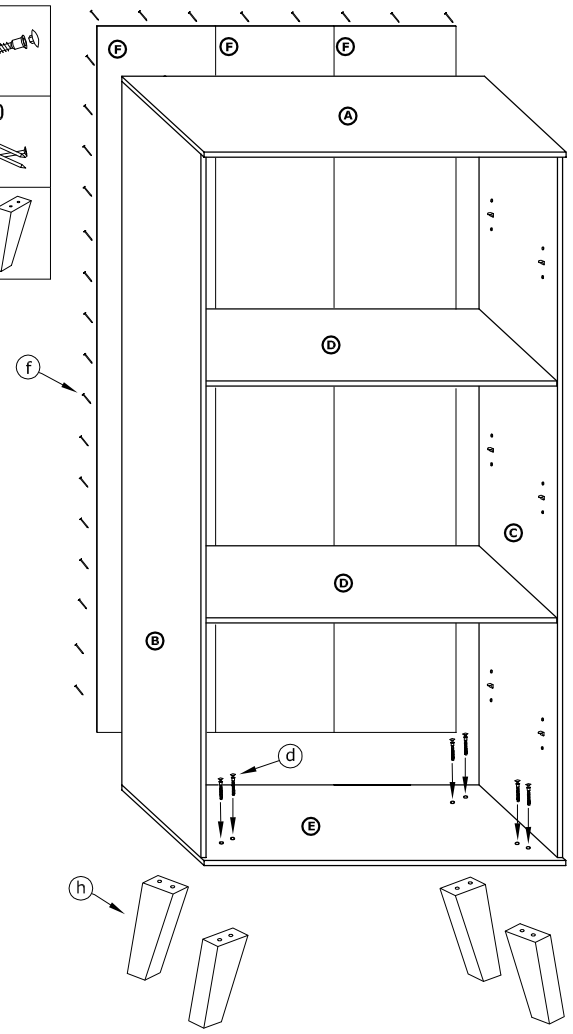

6

