

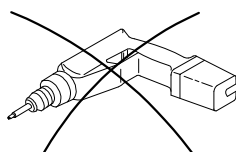

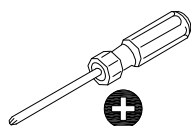

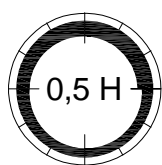

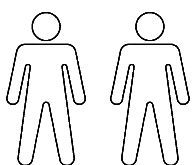
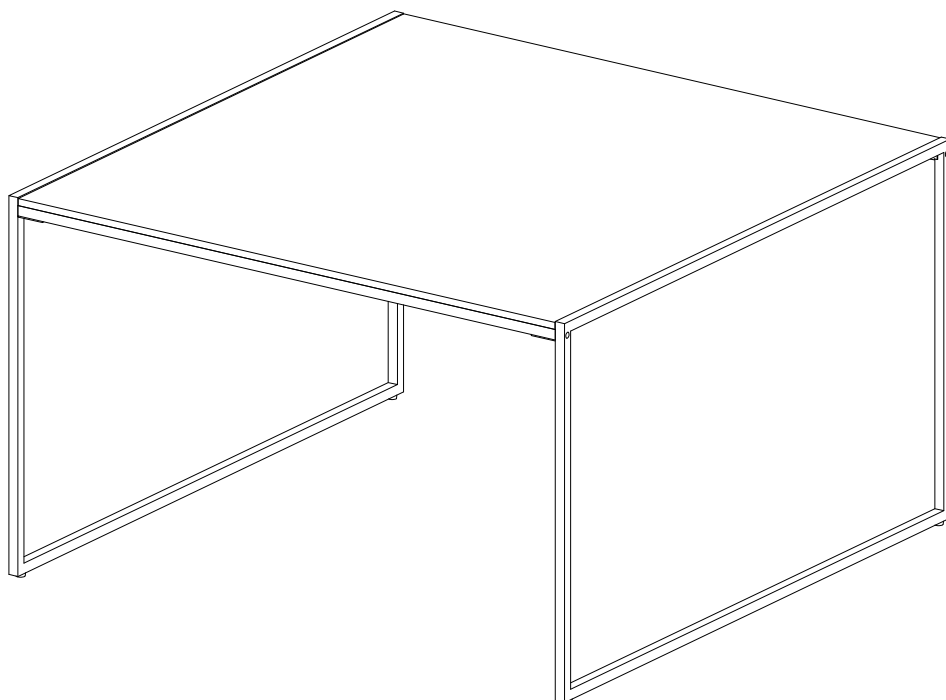
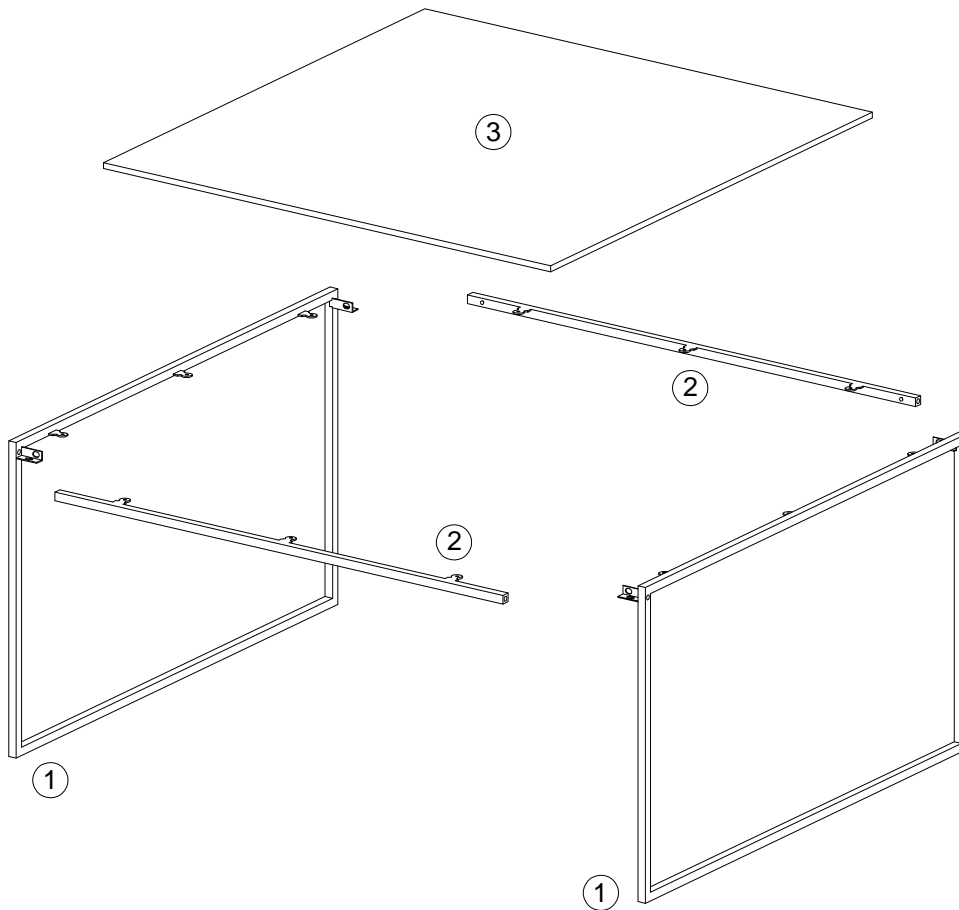

Infinity





			✓
①	2	800x475x48/13	
②	2	774x13x39/13	
③	1	773x800x9	





<p>A x 4</p>  <p>M5x28 mm</p>	<p>B x 8</p>  <p>M6x10 mm</p>	<p>C x 12</p>  <p>Ø4x10 mm</p>	<p>D x 4</p>  <p>M6/Ø13 mm</p>	<p>E x 1</p>  <p>4 mm</p>
<p>F x 1</p>  <p>3 mm</p>	<p>G x 12</p>  <p>Ø4/Ø9 mm</p>			

1

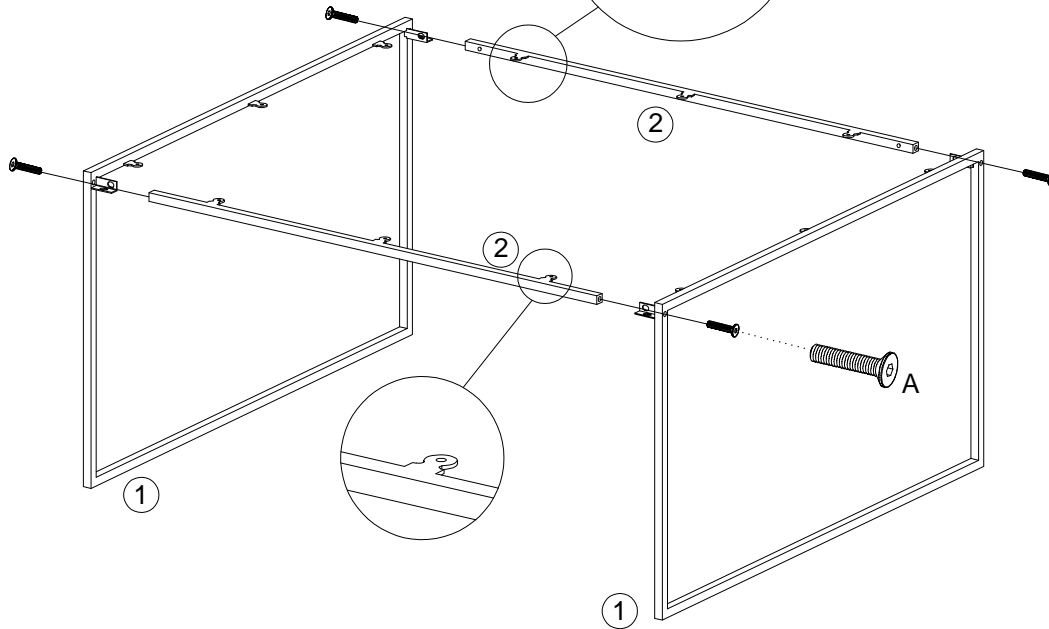
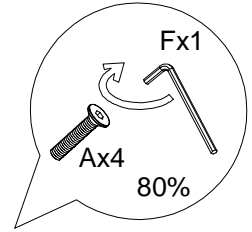
A x 4	F x 1
	
M5x28 mm	3 mm



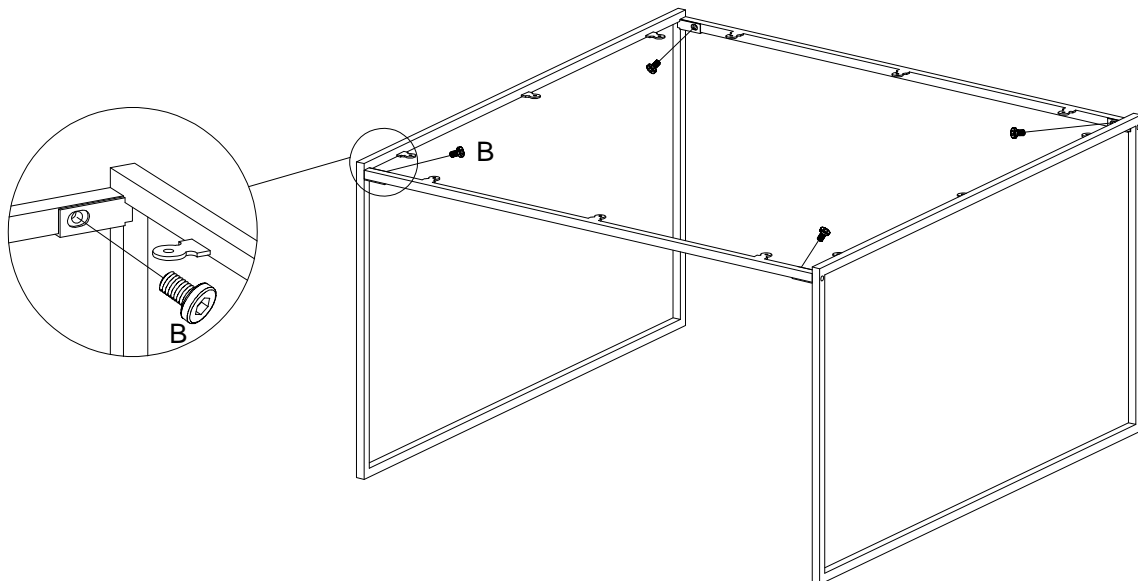
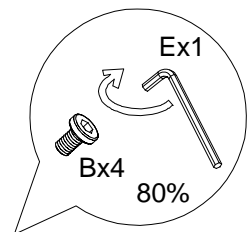

2

B x 4	E x 1
	
M6x10 mm	4 mm





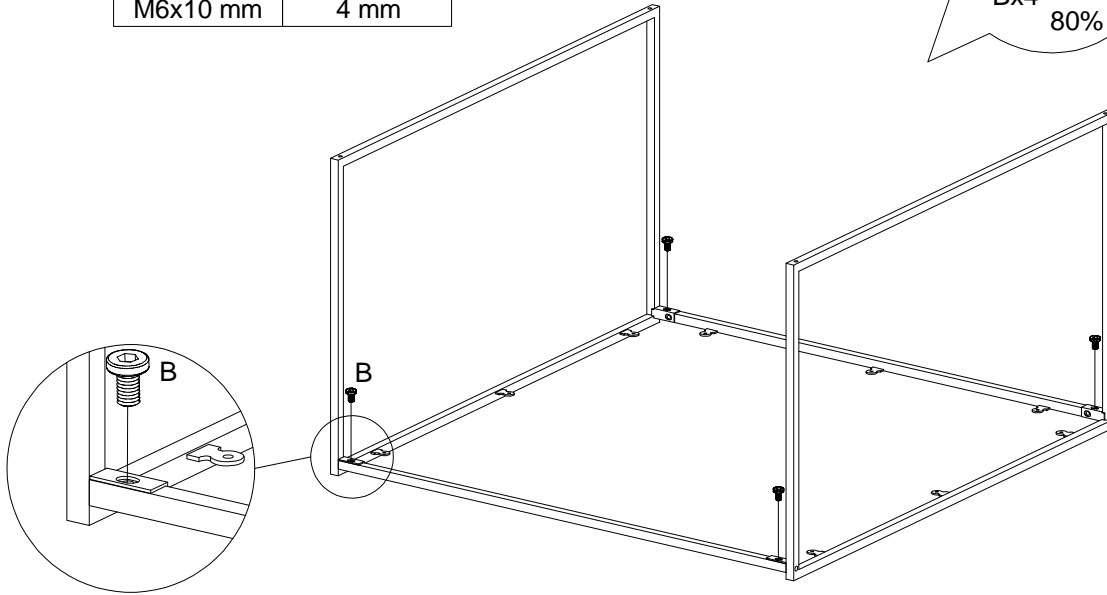
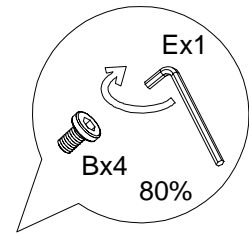

3

B x 4	E x 1
	
M6x10 mm	4 mm



4

C x 12	D x 4	E x 1	F x 1	G x 12
				
Ø4x10 mm	M6/Ø13 mm	4 mm	3 mm	Ø4/Ø9 mm

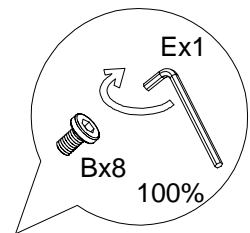
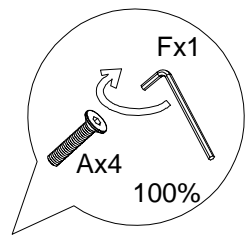
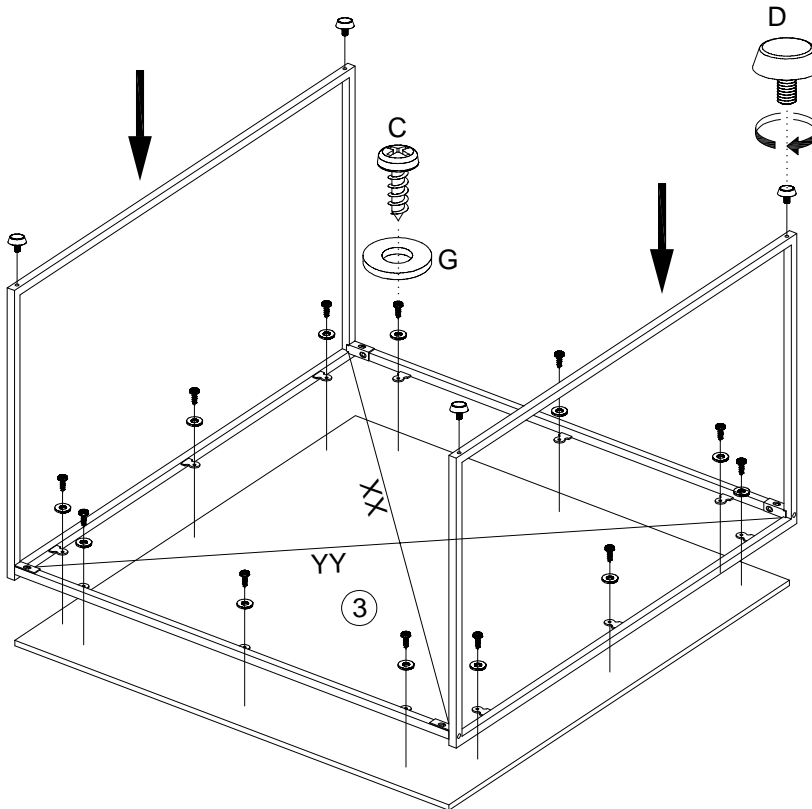

5

