

# TAWROS WM 18

- (PL) Instrukcja montażu  
 (CZ) Návod k montáži  
 (D) Montageanleitung  
 (GB) Assembly instruction  
 (F) Model d'emploi  
 (HU) Szerelési útmutató  
 (I) Istruzione di montaggio  
 (NL) Handleiding voor de montage

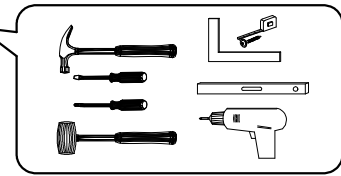

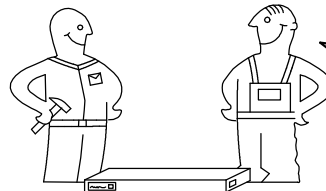



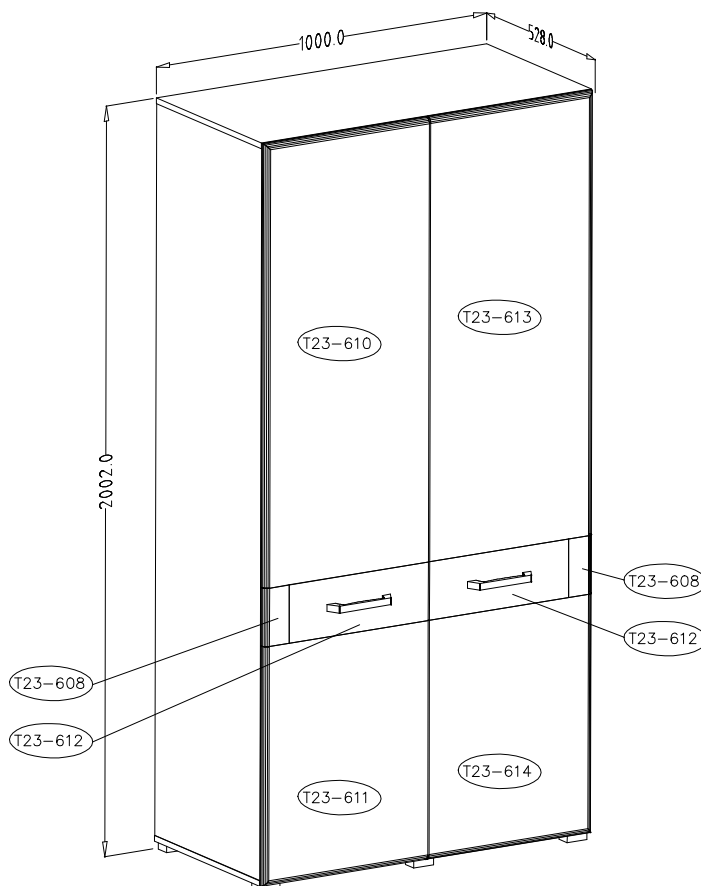
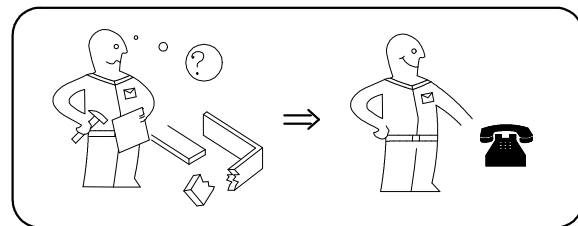
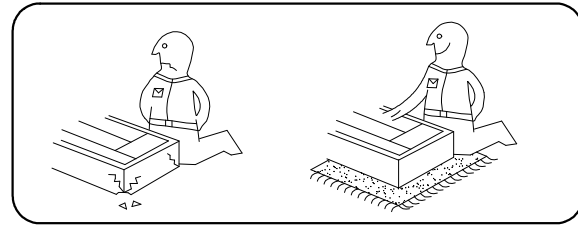



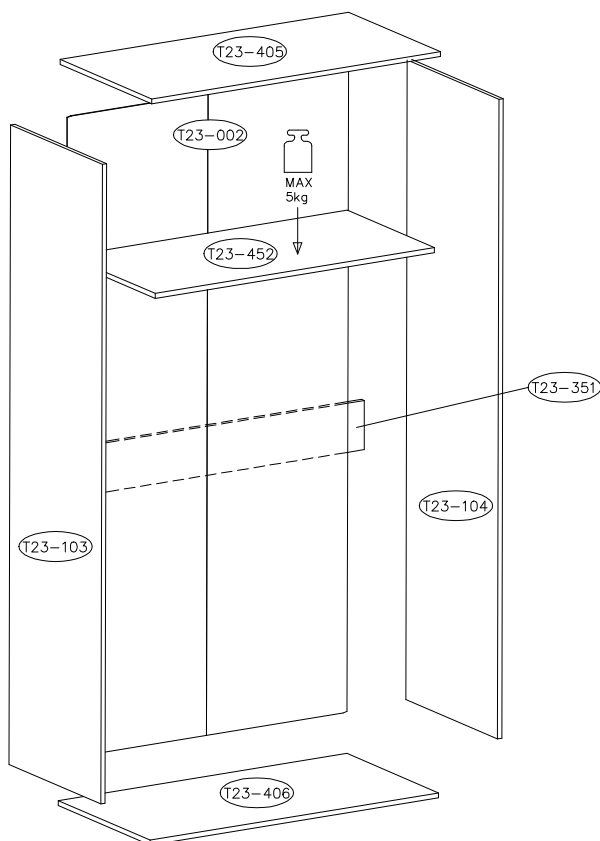
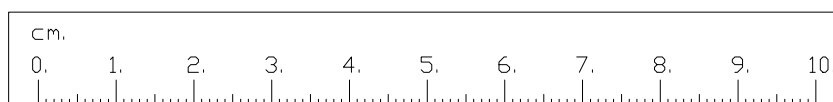
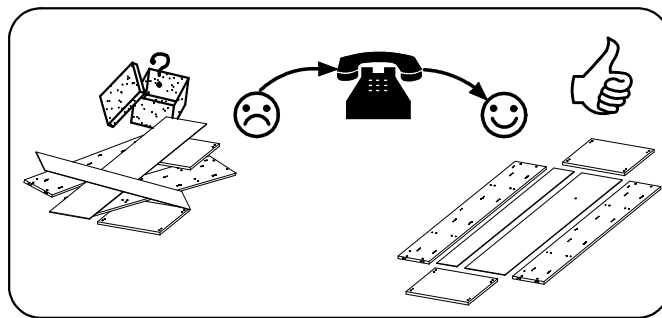
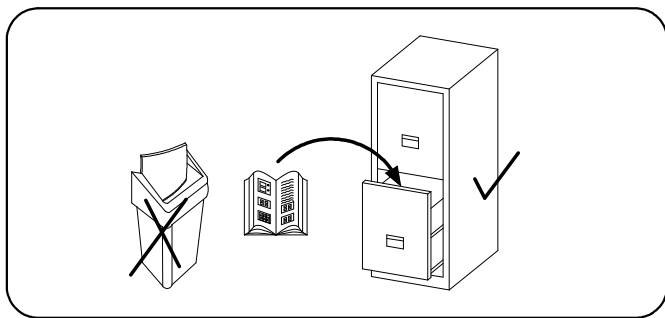







- (RU) Инструкция по монтажу  
 (RO) Instrucțiuni de montare  
 (SK) Návod k montáži  
 (TR) Montaj talimatı

⚠ Uwaga • Upozornění • Achtung • Attention • Caution • Figyelem ⚠ Attenzione • Opgelet • Внимание • Atenție • Upozornenie • Dikkat ⚠	
PL	Czyszczenie należy wykonać wyłącznie za pomocą ściereczki lub lekko nawilżonego ręcznika. Nie stosować środków czyszczących do szorowania.
CZ	Čistění je nutné vykonávat výhradně pomocí utěrky nebo lehce navlhčeného ručníku. Nepoužívejte čisticí prostředky obsahující abrazivní částice.
D	Bitte nur mit einem Staubtuch oder leicht feuchtem Lappen reinigen. Keine scheuernden Putzmittel verwenden.
GB	Please only clean with a duster or a damp cloth. Do not use any abrasive cleaners.
F	Le nettoyage se fait uniquement à l'aide d'un torchon ou d'une serviette légèrement mouillée.
HU	A tisztítás kizárólag törleruha vagy enyhén nedvesített törölköző segítségével végezhető. Súroló hatású tisztítószerket nem szabad használni.
I	Pulire esclusivamente con un panno o un asciugamano umido.
NL	Reinig alleen met een stofdoek of een lichtjes vochtige doek. Gebruik geen schurende poetsmiddelen.
RU	Очищайте от пыли тряпкой или слегка влажной ветошью. Не допускается применение чистящих средств, не предназначенных для ухода за мебелью.
RO	Curățarea trebuie efectuată numai cu o cârpă sau cu un prosop ușor umezit. Nu utilizați agenți de curățare abrazivi.
SK	Čistení je nutné vykonávat výhradně pomocí utierky nebo ľahko zvlhnutým ručníkom. Nepoužívajte čistiace prostriedky obsahujúce abrazívne častice.
TR	Lütfen sadece bir toz bezilye veya hafif nemli yumuşak bir bezle siliniz. Aşındırıcı temizlik malzemeleri kullanmayınız.

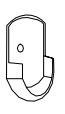

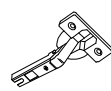
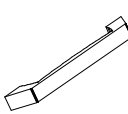
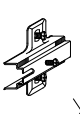
# TAWROS WM 18

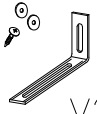

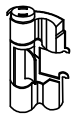
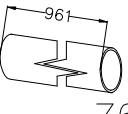
 A5	 A1	 B	 B1	 C	 8.0X30 D	 6.0X60 D1	 E	 I	 4.0X16 J
14	12	14	24	14	16	12	6	8	16
 P	 3.0X13 R3	 N1	 M	 X	 M4.0X25 A6	 V2	 V	 Z5	 96+ Z6
2	2	8	2	8	4	1	24	4	1

1

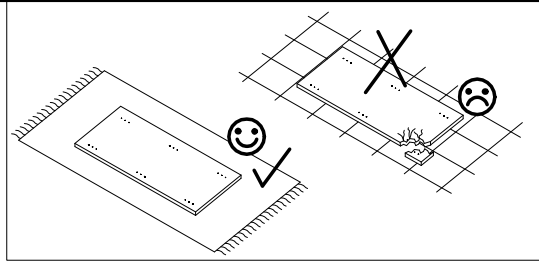

E

6

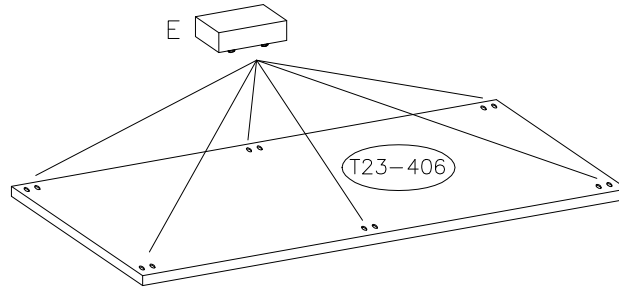

2

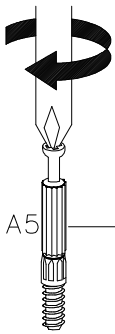

A5

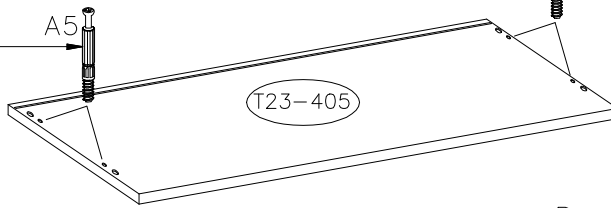

T23-405

A5

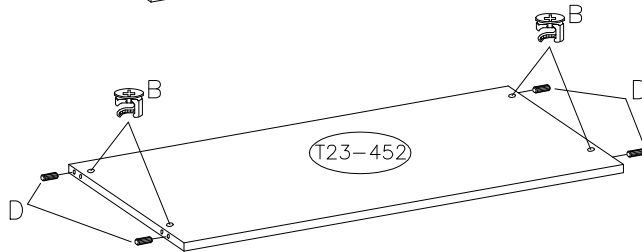

T23-452

B

D

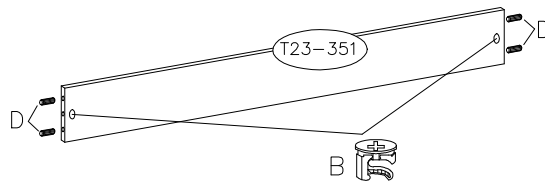

T23-351

D

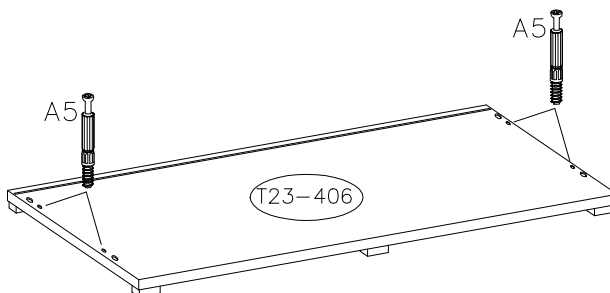

B



T23-406





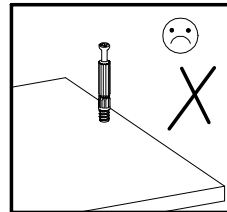
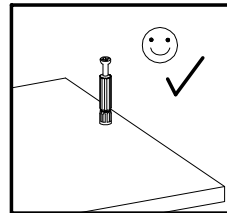

A5

A5

	8.0x30 	
A5	D	B
8	8	6



3

	3.0X13					
P		R3	A5	D	B	X
2		2	6	8	8	8

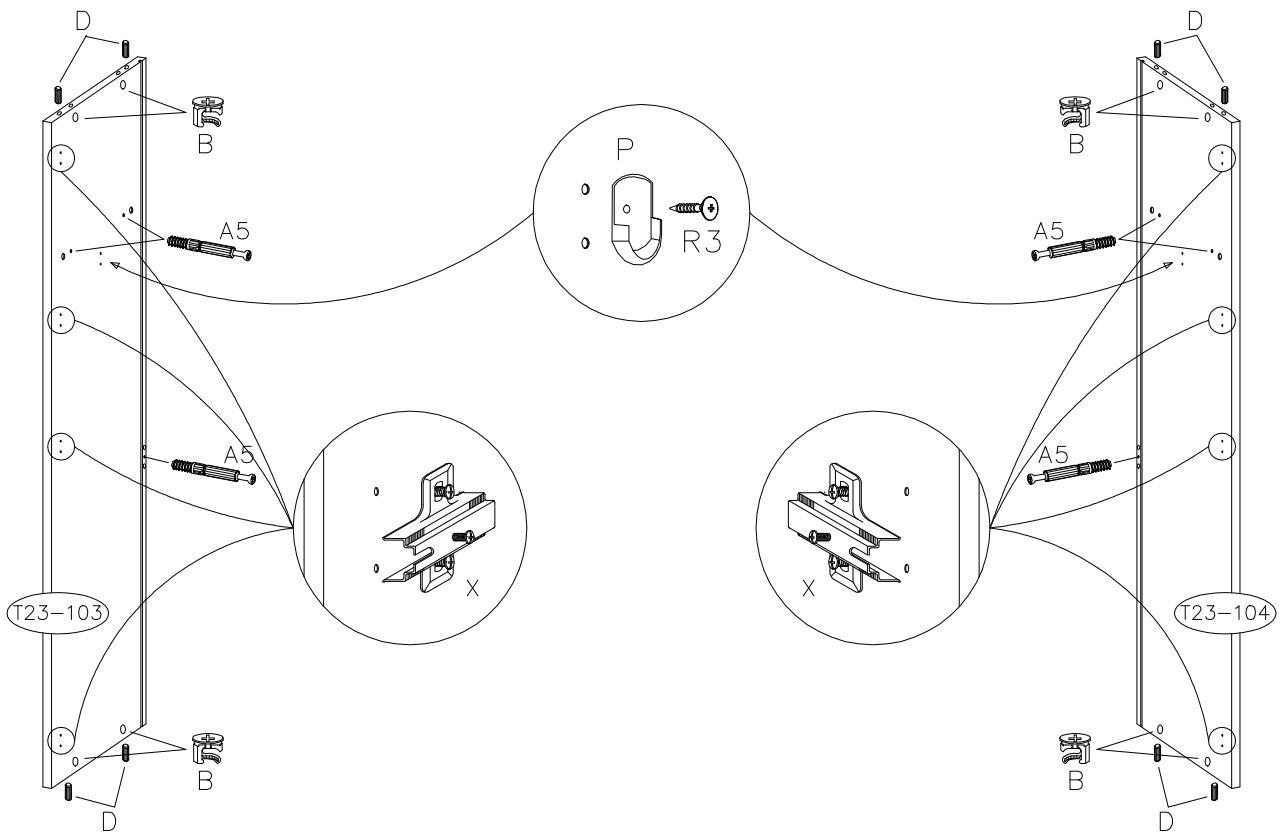

4

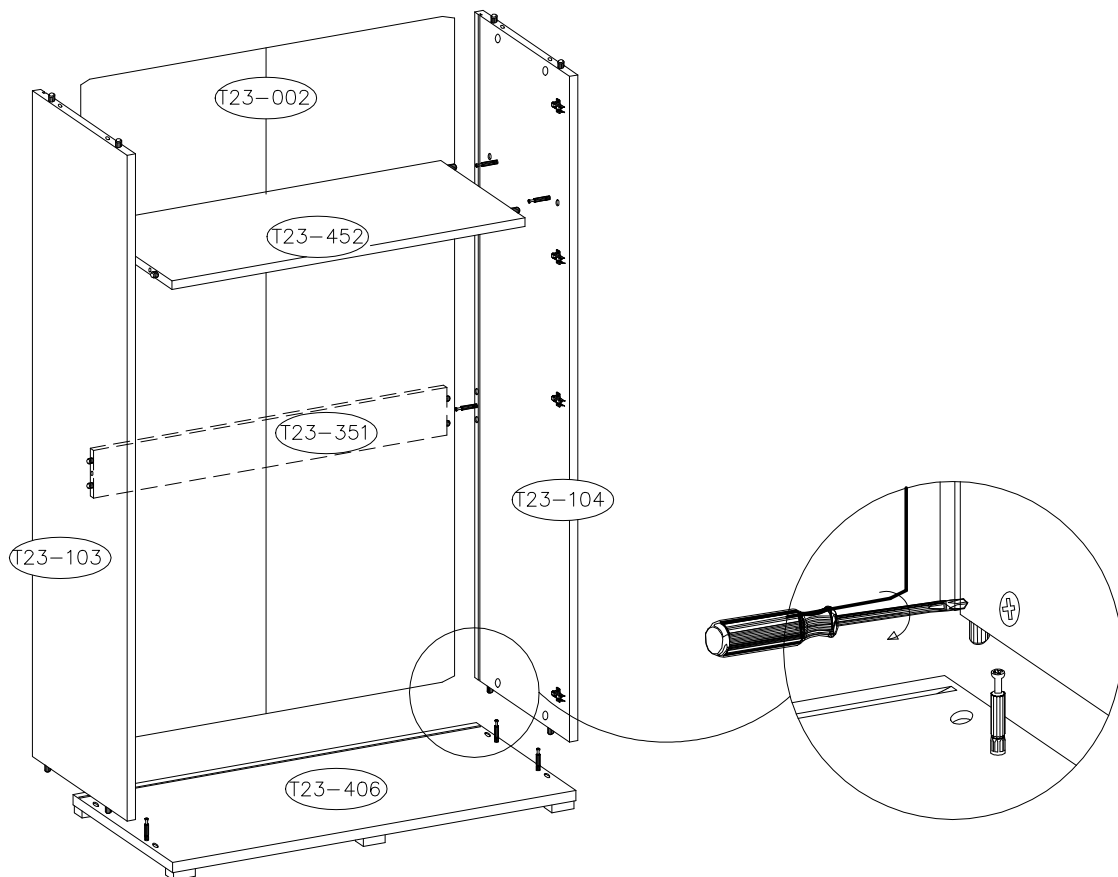

5

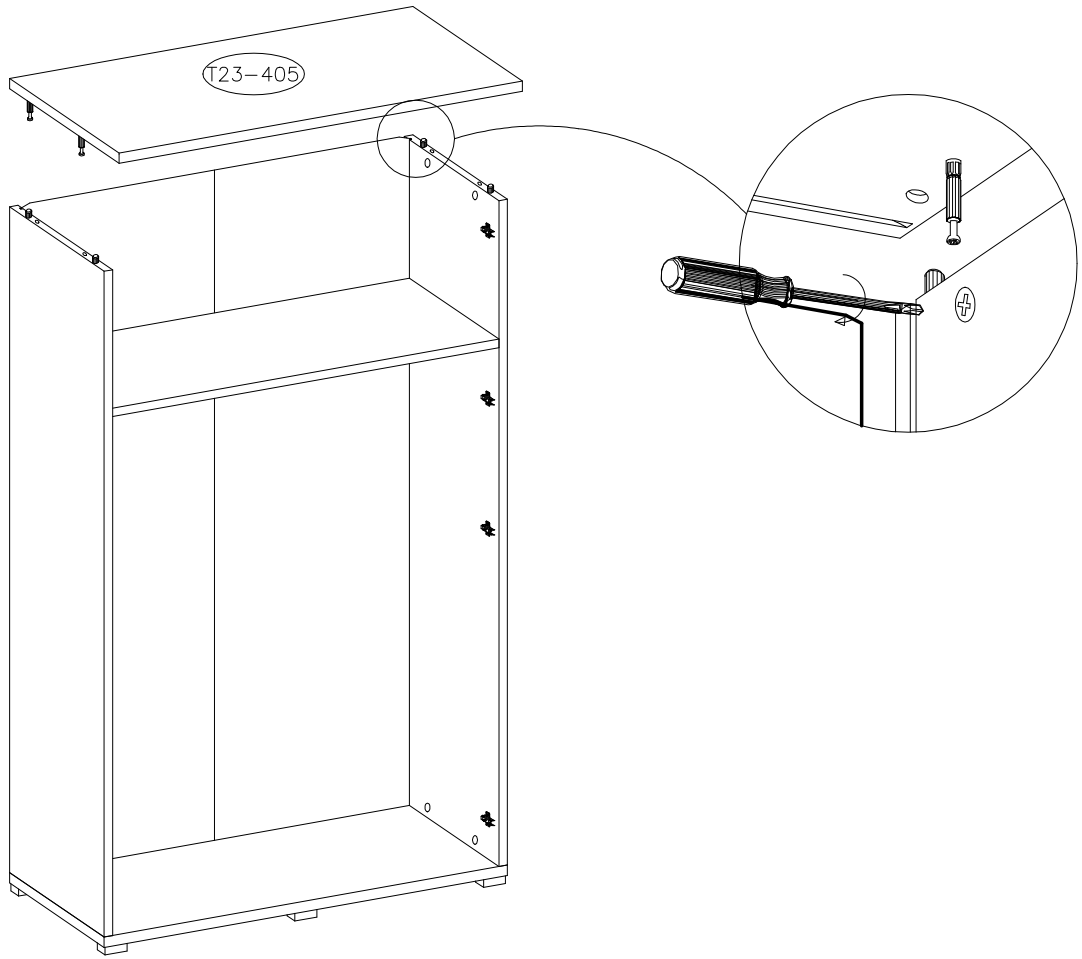

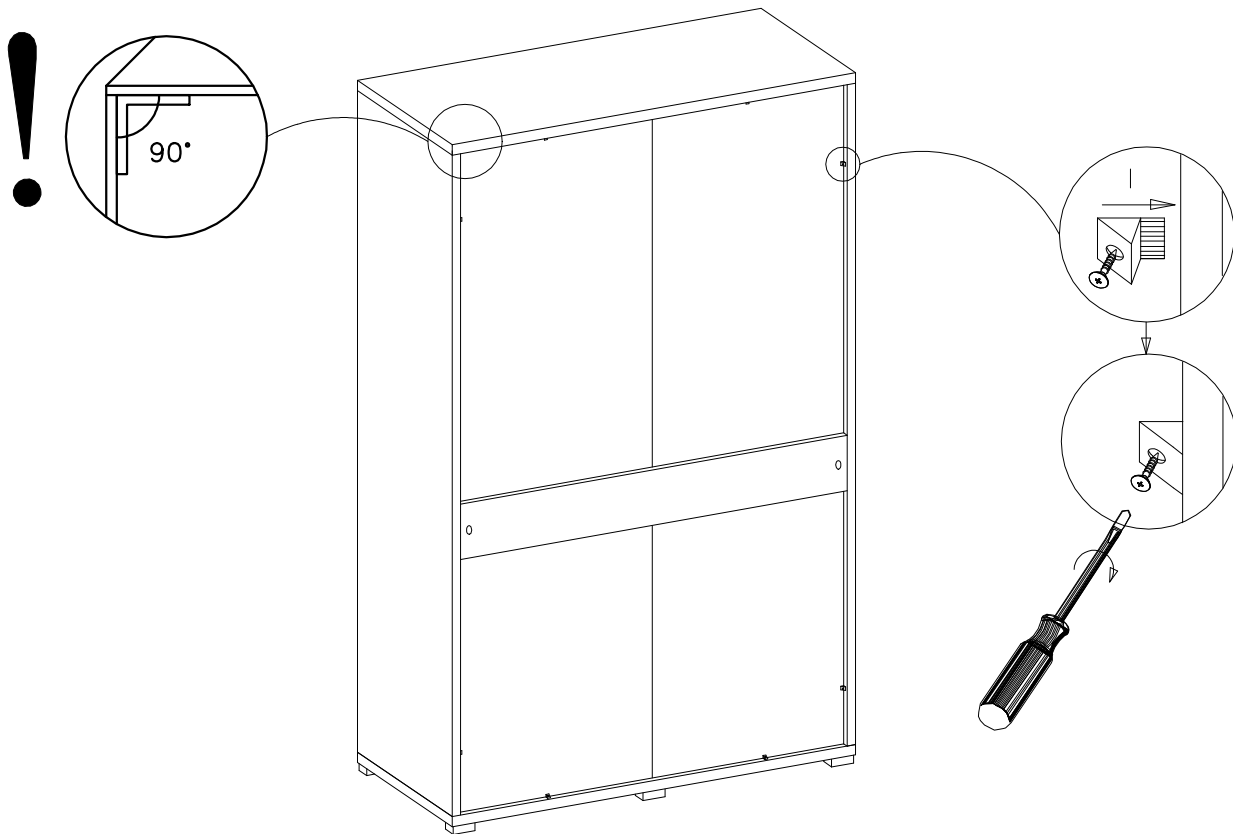

6



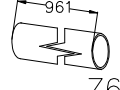

8  
8

7

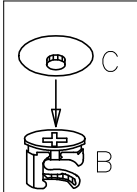
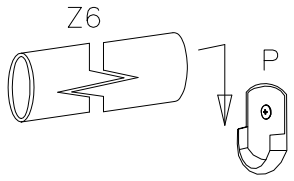
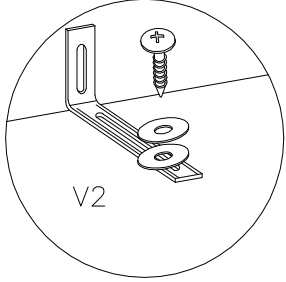
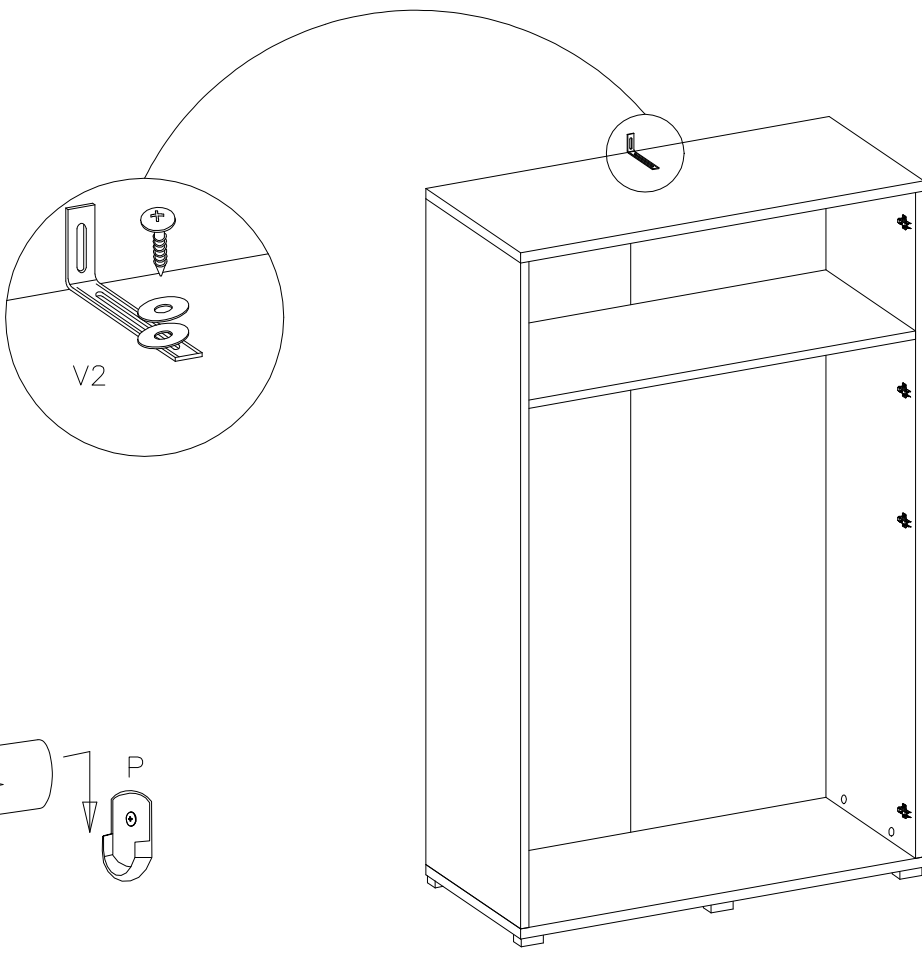
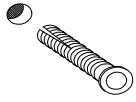

		
C	Z6	V2
14	1	1

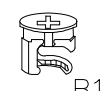

8

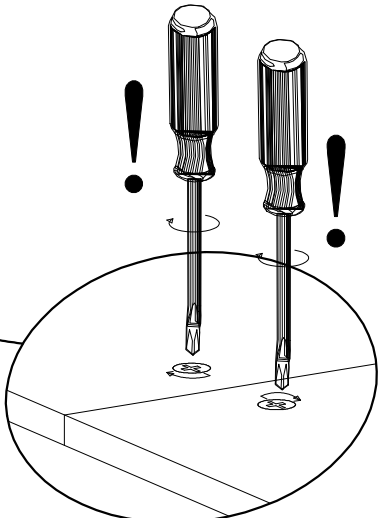
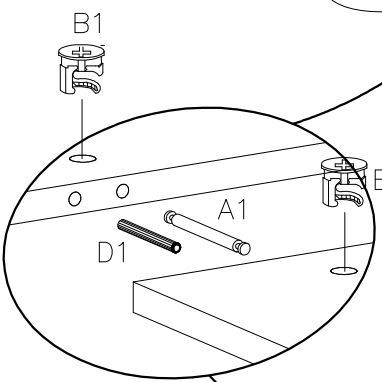
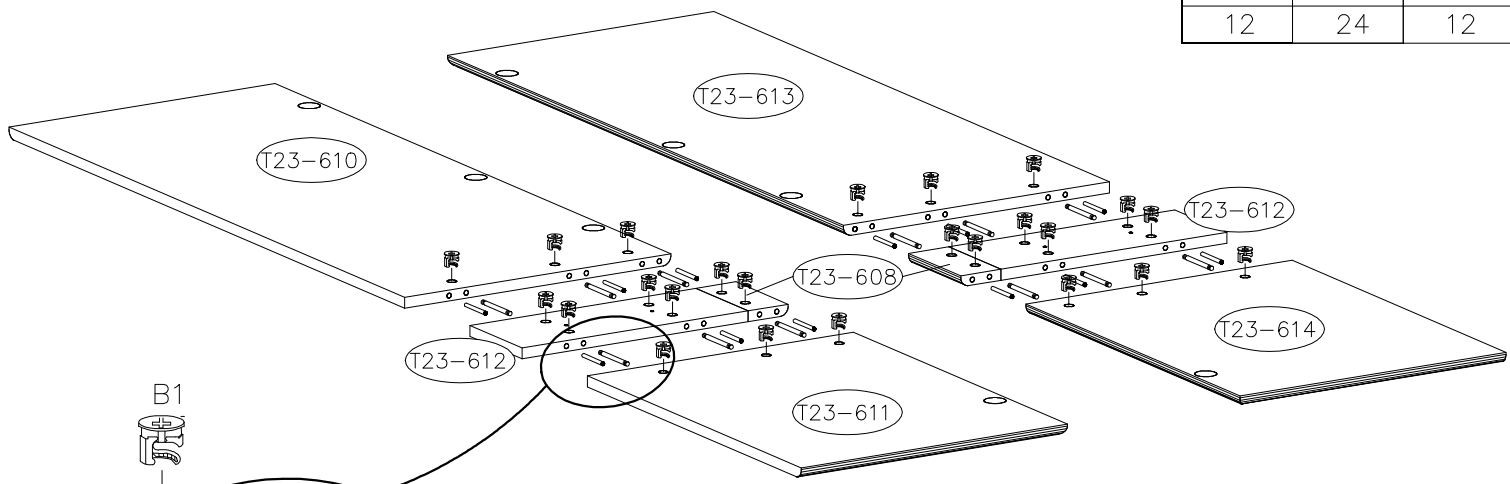

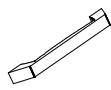
		
A1	B1	6.0X60
12	24	12

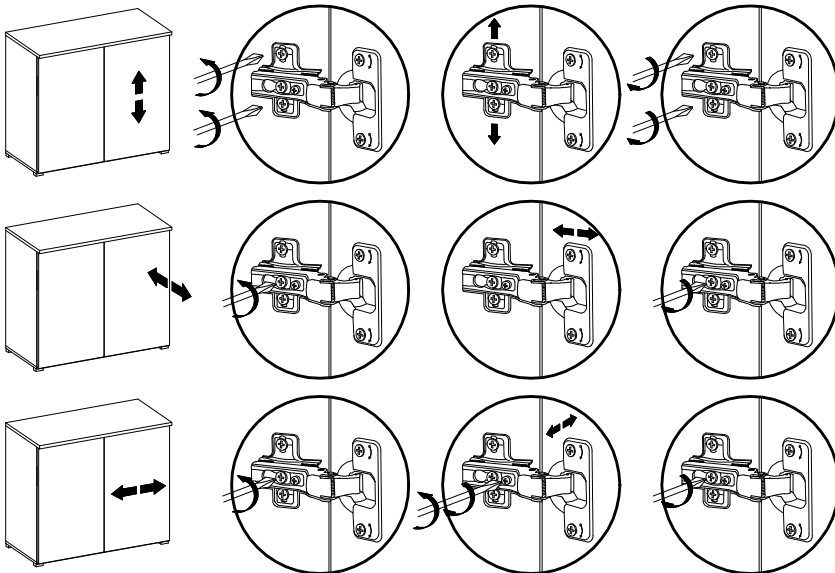
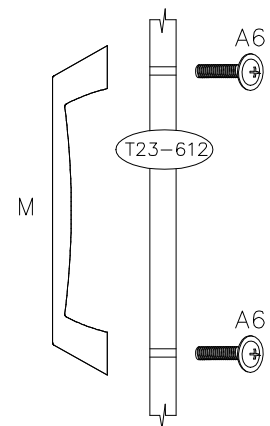
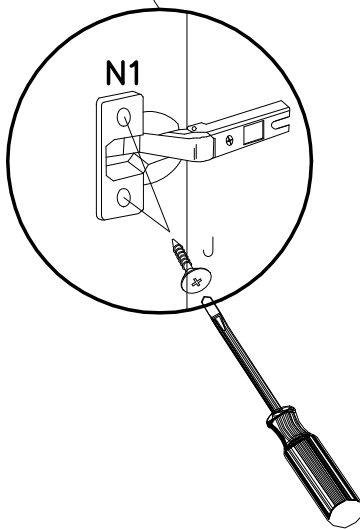
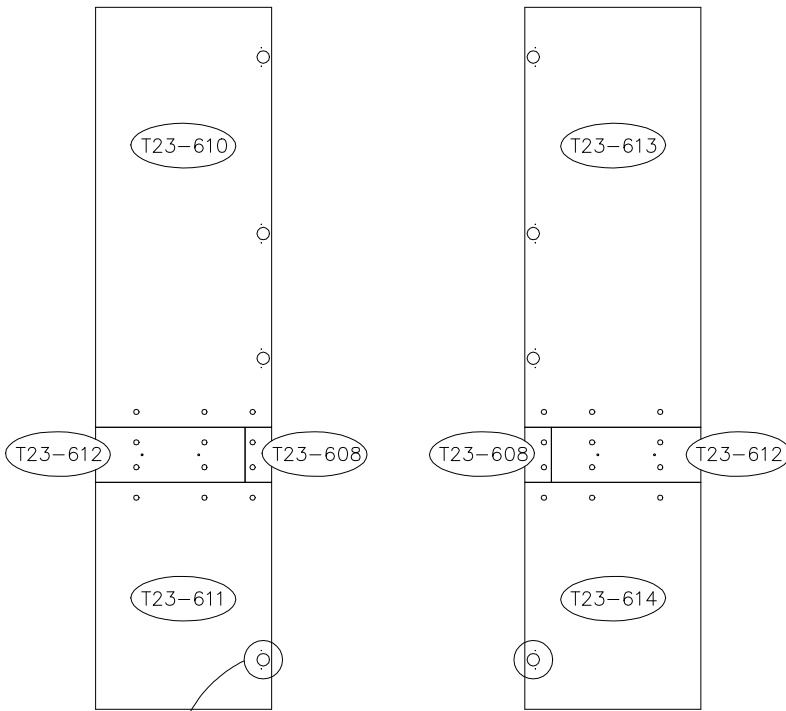

			
N1	M	M4.0X25	4.0X16
8	2	4	16



- F** Mettre la porte (égaler les gonds)
- I** Regolare la porta (livellare le parentesi)
- D** Turen einstellen (Scharniere justieren)
- GB** Adjusting the doors (adjusting the hinges)
- NL** Deuren instellen (scharnieren afstellen)
- PL** Nastawic drzwi (wyrownac zawiasy)
- TR** Kapilarin ayarlanması (menteşelerin seviye ayarı)
- RU** Регулировка дверей (регулировка шарнира)
- RO** Ajustați ușa (alineați balamalele)
- CZ** Seřid'te dveře (vyrovnejte závěsy)
- SK** Zrad'te dvere (vyrovnajzte závesy)
- HU** Állítsa be az ajtót (igazítsa be a zsanérokot)

	
Z5	V
4	24

